

CODE: ARAMIS III - ADR3

THE BLUE PLANET PROJECT TRILOGY

FOR YOUR EYES ONLY

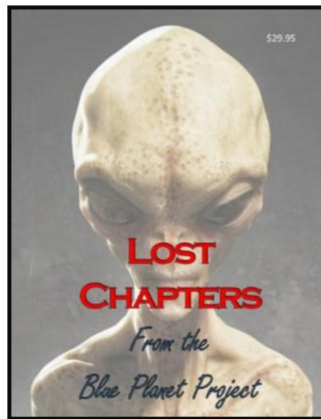

All 3 Books in One

- ★ BLUE PLANET PROJECT ALIEN LIFEFORMS
- ★ BLUE PLANET PROJECT LOST CHAPTERS
- ★ BLUE PLANET PROJECT CONSPIRACY

CODE: ARAMIS III - ADR3-24SM

THE BLUE PLANET PROJECT

FOR YOUR
EYES ONLY



Anonymous

The material in this book has not been submitted to or approved by any U.S. intelligence agency. If anything is discovered that is considered by your agency to be classified, notify the publisher.

BLUE PLANET PROJECT

The Encyclopedia of Alien Life Forms

Note - This document is the alleged result of the actions of one or more scientists creating a covert, unauthorized notebook documenting their involvement with an Above Top Secret government program.



These glyphs read: "Planet Blue" and the anterior glyphs say "Plan, Design, Layout, Proposal, Profuse (or Plentiful), In other words: "Profuse Blue Planet Project"

Additional note: Michael Relfe personally saw a photocopy of the original spiral bound notes during a UFO conference around 1991.

CONTENTS

1. THE INVISIBLE GOVERNMENT

- The U.S. Government Counter Intelligence Organizational Chart...6
- U.S. Space Counter Intelligence HQ, Organizational Chart...7
- Operation Majority...9
- The U.S.'s Alien Cover-up...11
- Top Secret - Majic...13
- The "Majic Projects"...14
- Majic's Contingency Plans...15
- Majic's Secret Weapons Against the Aliens...16
- Information from Inside Report Number...18
- NSA Security System...20

2. FACTS ABOUT ALIENS ON EARTH - CODE: OMNIDATA

- Facts About Aliens on Earth...21
- Main Important UFO Crashes, Under Ultra-Secret Cover-ups...22
- Extraterrestrial Classifications...23
- Alien Presence on Earth...23

3. CATTLE MUTILATIONS

- My General Personal Observations...25
- Black Helicopter Involvement in Mutilations...26

4. THE ANTARIAN CONNECTION - CODE: OMNICORD

- Time and UFOs...28

5. CROP CIRCLES PHENOMENA - CODE: SEC

- Crop Phenomena: Circles Affair...30

6. DULCE BASE - CODE: J.B. III

- The Dulce Base...33
- Caught in the Game...33
- Whose Planet is this...34
- The Secret Activity...35
- R&D and the Military Industrial Complex...35
- Surviving the Future...35
- The Transamerican Underground Subshuttle System, (T.A.U.S.S.) ...36
- Overt and Covert Research...37
- Each Base has its own Symbol...39
- Inside the Dulce Base...40
- The Town of Dulce...41
- Mind Manipulation Experiments...41
- Better living Through Bio-Tech...42

7. SOME KINDS OF ALIEN LIFE FORMS WE KNOW ABOUT

- U.S. Government Data from Autopsies of Aliens...45

- Extra-Terrestrial Data, Code: EBEs
 - The First EBE
 - KRLL
- Rigelians
 - The Rigelian Saga
 - Alien Bases at Sol III Perimeter
 - Project BETA, The Study of Grey Psychology
- Taxonomy of some Extraterrestrial Humanoids
 - Greys Data from Autopsies
 - Type A
 - Type B
 - Type C
 - Nordics Data from Autopsies
 - Type D
 - Oranges Data from Autopsies
 - Type E

8. ALIEN TECHNOLOGY

- Alien Crafts with Dimensional Factors and/or Dimensional Origin...77
- The US Government and Alien Technology...78
- The Implant or S.B.M.C.D....78
- Aliens and the Electromagnetic Spectrum...80
- Alien Artifacts used at Mutilations...80

9. GOVERNMENT SECRET TECHNOLOGY

- Mystery Helicopters and Mutilations...84
- Surveillance Devices...84

10. ALIEN ABDUCTIONS

- The Monitors...87
- The Case for Alien Abductions...87
- The Most Common Areas Examined by the Aliens...92
- Biological Specimens, Samples taken for Abductees, Witnesses...95
- Pregnancy...96
- Our Genetic Code is under Siege...98
- The Metagene Factor...100

11. INCULCATION DEVICES AND THE PRACTICE of MANIPULATION of THE MIND

- Learning, Teaching and Assimilation techniques of space societies...107
- Inculcation Devices...108
- Inculcation Bar Device...108
- Inculcation Monitor...108
- Catecholine Beta-Lipotropin 9753...109
- Rapid Inculcation Processes...109

ISBN-13:978-0-9914942-4-8

(C) Copyright 2013 Gil Carlson

Blue Planet Press
Contact us at: BluePlanetPress@aol.com

To discover the rest of the books in this Blue Planet Project Series:
www.blue-planet-project.com/



The material in this book has not been submitted to or approved by any U.S. intelligence agency. If anything is discovered that is considered by your agency to be classified, notify the publisher.

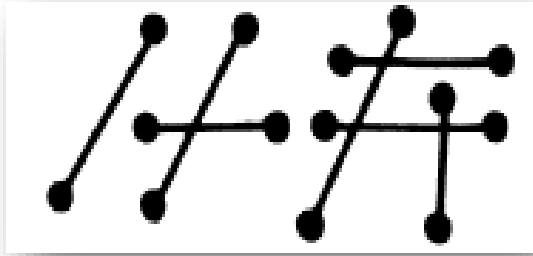

The following document is believed to be the personal notes and scientific diary of a scientist who was contracted by the government over several years to visit all crash sites, interrogate captured Alien Life Forms and analyze all data gathered from that endeavor. He also wrote notes on or about any documents which he came in contact with, which in any way related directly or indirectly to the organization, structure or operation for the collection of such data.

This individual was discovered to have kept and maintained such personal notes and therefore was scheduled for termination. He narrowly escaped termination by the government and is currently in hiding out of this country.

We believe his involvement in these investigations span over a thirty-three (33) year period. He was soon discovered and immediately went into hiding in 1990

When you read this document, it may disturb you. The real facts have a tendency to do exactly that, but this information needs to get to the general public. I caution you to use your best judgment when allowing a minor child to read this document.

At this time, to the best of the data we have available, there are at least one hundred and sixty (160) species or races of Aliens from different galaxies, stars and planets we have encountered. You will find as much data (as we have available thru 1990) on each race in the following pages, as each race is discussed. There are still more Aliens we haven't encountered yet but we feel it won't be long before we do... There will be more to come later.

1. THE INVISIBLE GOVERNMENT

CODE: NSC

AC and the Government
23-C

U.S. COUNTER INTELLIGENCE ORGANIZATIONAL CHART

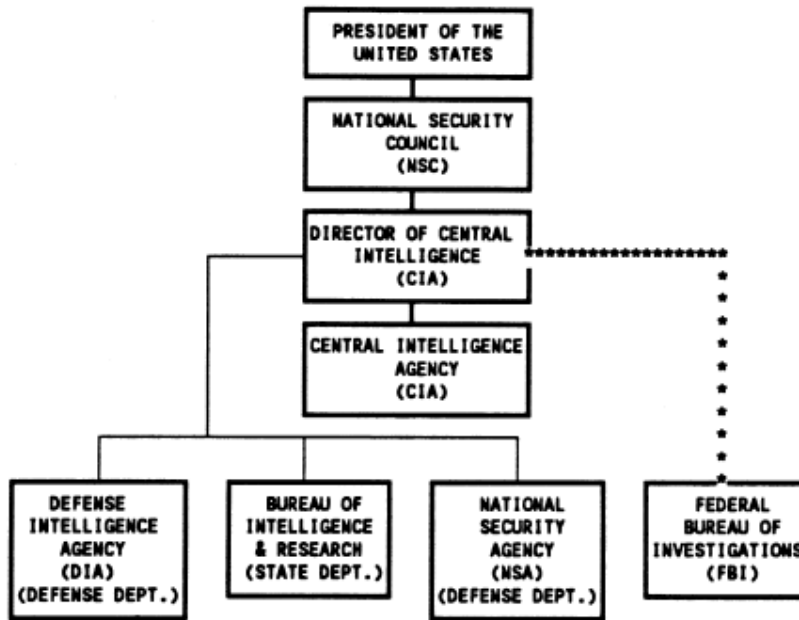

—— Control

—— Coordination; Control of Budgetary Resources

***** Coordination Only

STAR WARS CITY (SDI/01)

Code: Strategic Defense Initiative (SDI) also known as Spaceship Defense Initiative (Star Wars Project).

Control Location: Cheyenne Mountain, Colorado Springs.

U.S. SPACE COUNTER INTELLIGENCE HEAD QUARTERS

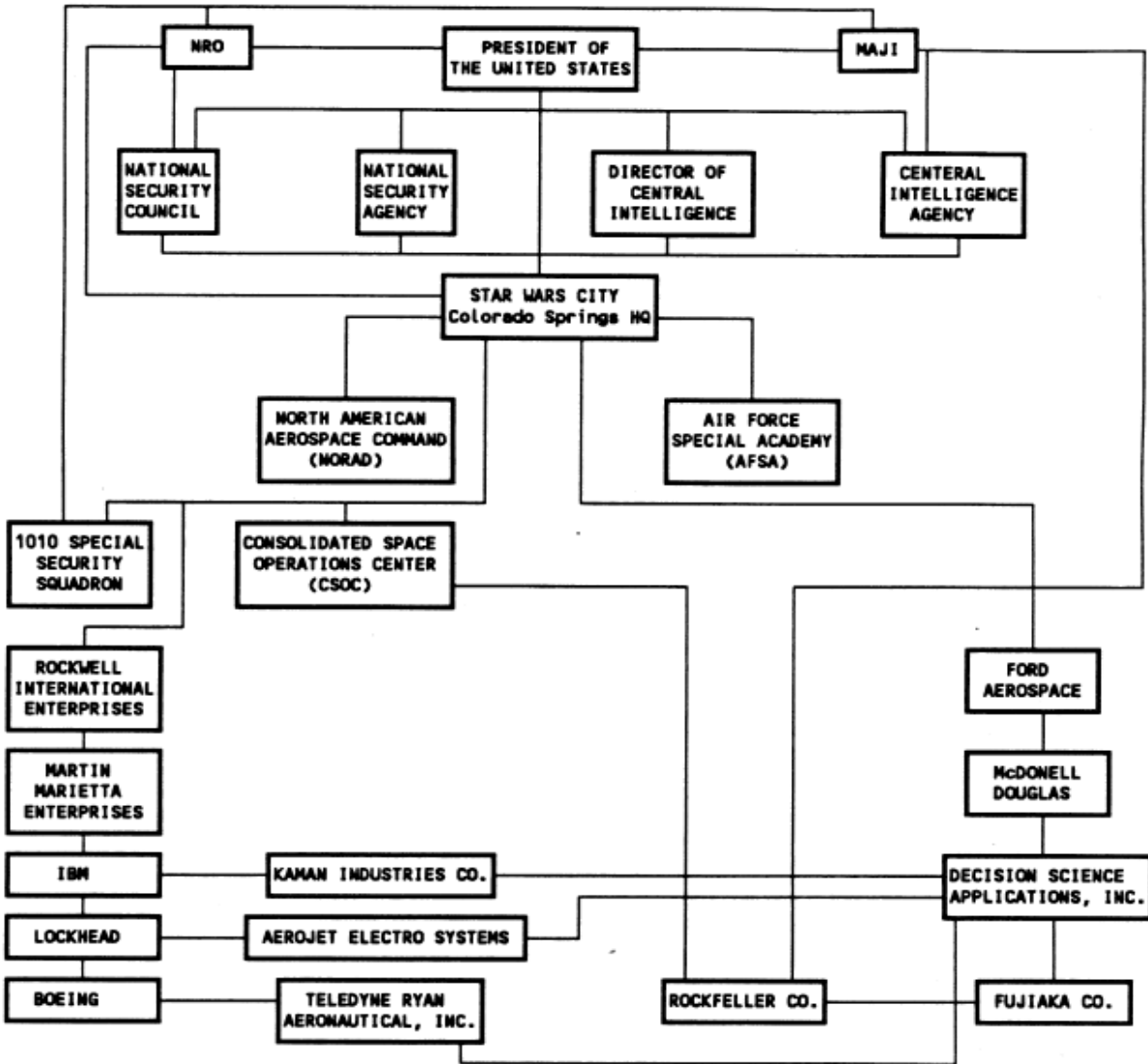

THE INVISIBLE GOVERNMENT

ADR/23 - NSC OCM A7BMC - CODE: MIRAMA 55A - ACL - 3 65ATN-6 (MOZART) # 6.2

The National Security Council, Old Executive Office Building, Washington, DC. 20506, Phone Number (202) 395-4974, was established by the National Security ACT of 1947 (61 Stat. 496;50 U.S.C. 402).

President **Truman** signed the National Security ACT on July 26, 1947 and immediately named Secretary of the Navy Forrester as the first Secretary of Defense. Forrester and others were sworn in September 17, 1947.

The ACT established "under the National Security Council" a Central Intelligence Agency headed at that time by "Director", Rear Admiral **Roscoe Hillenkoeter**. It provided a comprehensive program for future Security of the United States, and the ACT created the NSC to advise the President with respect to the integration of domestic, foreign, and military policies relating to the National Security, with the special duty to "Access and Appraise the objectives, commitments, and Risks....".

The funds for the **CIA** were hidden in the annual appropriations for other agencies. Today, collectively, U.S. Intelligence Operations (almost totally clothed in secrecy) cost more than \$1 Billion Dollars annually.

The researchers Moore, Shandera, and Friedman have referred to briefing document:

Operation Majestic 12 NSC, MJ-12 Special Studies Project

MJ-12 is said to be a TOP SECRET Research and Development, Intelligence Operation established by President Truman on September 24, 1947. MJ-12 was a "Committee" set up inside the NSC. In 1954, President Eisenhower signed the Secret Executive Order, "Order Number 54-12".

Newsweek of June 22, 1964, carried a review of "The Invisible Government"....."One of their major revelations is the existence of the Special Group "54-72", a hitherto classified adjunct of the National Security Council, specially changed by the President with ruling on special operations." The NSC called this group the "54-12" committee "which gave the President responsibility of approving all 'Black' covert projects."

This committee has undergone several changes over the years, and since then, has been called the "SPECIAL COMMITTEE", the "303 COMMITTEE" and currently the "40 COMMITTEE" and is represented as XXXX "the double - double cross." It is described as the "Directorate" of the NSC.

The "40 COMMITTEE" has access to advanced technology and teams to cover-up, "the cover-ups"! In the past, this committee was headed by Dr. **Henry Kissinger** (code name: 'The Overseer') when he gave William Colby permission to commission Howard Hughes, *Summa Corporation* to build a submarine, and a special craft or salvage vessel. The salvage vessel called "Glomar Explorer", was equipped with refrigeration capacity for up to a hundred bodies. (Why???) In early May 1988, the former President **Ronald Reagan** said he often wonders what would happen if the Earth was invaded by a "Power from Outer Space". It has also been reported that the President is briefed on UFO developments and "Alien Visitors, by Planetary Intelligence group #40 (PI-40).

OPERATION MAJORITY

Operation Majority is the name of the operation responsible for every aspect, project and all consequence of Alien presence on Earth.

Majesty was listed as the code word for the President of the United States for communications concerning this information.

Grudge contains 16 volumes of documented information collected from the beginning of the United States investigation of the Unidentified Flying Objects (UFOs) and Identified Alien Crafts (IACs). The project was funded by the CIA, (confidential funds, non-appropriated) and money from the illicit drug trade. Participation in the illegal drug trade was justified in that it would identify and eliminate the weak elements of our society.

The purpose of project Grudge was to collect all scientific, technological, medical and intelligence information from UFO & IAC sightings as well as contacts with Alien Life Forms. This orderly file of collected information has been used to advance the United States Air Force Space Program, (TOP SECRET).

Jason Society (Jason Scholars)

President Eisenhower (former) commissioned a secret society known as the Jason Society (or Jason Scholars) under the leadership of the following:

- Director of Central Intelligence, Allen Welsh Dulles
- Dr. Zbigniew Brzezinski, President of Trilateral Commission from 1973 until 1976

Dr. Henry Kissinger, leader of the scientific effort, to sift through all the facts, evidence, technology, lies and deceptions and find the truth of the Alien question
The society was made up of thirty-two (32) of the most prominent men in the U.S.A.

MJ-12 is the name of the secret control group inside the Jason Society. The top twelve (12) members of the thirty-two (32) members of the Jason Society were designated the MJ-12. MJ-12 has total control of everything. They are designated by the code J-1, J-2, J-3, etc. all the way through the members of the Jason Society. The director of Central Intelligence was appointed J-1 and is the Director of the MJ-12 group.

MJ-12 is responsible only to the President of the United States. Believe it or not, *MJ-12 runs most of the world's illegal drug trade*. This was done to hide funding and thus keep the secret from the Congress and the people of the United States. It was justified in that it would identify and eliminate the weak and undesired elements of our society.

* The actual cost of funding the Alien connected projects is higher than anything you can imagine.

It was the MJ-12 group who ordered the *assassination of President Kennedy* when he informed MJ-12 that he was going to tell the public all the facts of the Alien presence.

He was killed (coup de grace) by the Secret Service Agent driving his car, (who fired the final and most critical shot) and it is plainly visible in the film, which has been held from public view, and the twenty-two (22) material witnesses to the Kennedy's murder died within two (2) years thereafter.

MJ-12 has a special program for elimination of the considered weak members from U.S.A.'s society.

- ON A BIG SCALE - Creation of an artificial disease known as "AID'S"
- ACCIDENTS - of people who we know to have been secretly eliminated
- DISAPPEARANCES/MURDER - of some people who we know to have been secret eliminations also

The above, are just a few of the tactics which MJ-12 uses when they consider people Dangerous by knowing too much!

A secret meeting place was constructed for the MJ-12 group in Maryland and was described as only accessible by air. It contains full living, recreational, and other facilities for the MJ-12 group and the Jason Society. It is code named "The Country Club". The land for *The Country Club* was donated by the Rockefeller Family.

Only those with TOP SECRET-MAJIC clearances are allowed to go there.

MAJI = Majority Agency for Joint Intelligence

All information, disinformation, and intelligence is gathered and evaluated by this Agency.

This agency is responsible for all disinformation and operates in conjunction with the CIA, NSA, DIA, and The Office of Naval Intelligence. This is a very powerful organization and all Alien projects are under its control.

MAJI is responsible only to MJ-12. MAJIC is the security classification and clearance of all Alien connected material, projects, and information.

MAJIC = means MAJI controlled, (MAJI plus Controlled = MAJIC).

NOTES: MJ-1 is the classification for the director of MAJIC, who is the Director of the CIA and reports only to the President. Other members of MAJI are designated MJ-2, MJ-3, MJ-4, etc. This is why there is some confusion about references of MJ-12, the group or MJ-12 the person.

- Designation for MJ-12, the group are MAJI or MAJIC
- Designation in official documents about MJ-12 means the person only.

THE U.S.'s ALIEN COVER-UP

It seemingly all began thousands of years ago, but for the purpose of this discussion, let's start with some events that we all are familiar with.

In 1947, two years after we set off the first nuclear explosion that our current civilization detonated, came the Cap-Mantell episode, where we had the first incident of a military *confrontation with extra-terrestrial* that resulted in the death of the military pilot. It is quite evident now that our Government did not know quite how to handle the situation. In 1952, the nation's capital was overflowed by a series of disks.

It was this event which led to the involvement of the United States Security Forces (CIA, DIA, NSA, & FBI) to try to keep the situation under control until they could understand what was happening.

During this period, the original members of the group were:

1. Secretary James Forrestal
2. Admiral Roscoe H. Hillenkoetter
3. General Nathan P. Twining
4. General Hoyt S. Vandenberg
5. General Robert M. Montague
6. Dr. Vannevar Bush
7. Dr. Detlev Bronk
8. Dr. Jerome Hunsaker
9. Dr. Donald Menzel
10. Dr. Lloyd V. Berkner
11. Mr. Sidney W. Souers
12. Mr. Gordon Gray

This group was a *working group*, established by the Government, known as MJ-12.

The MJ-12 group has been an existing group since it was created with new members replacing others that died. For example, when Secretary Forrestal was upset at seeing the United States sold out in World War II, he wound up being sent to a Naval hospital for emotional strain. Before relatives could get to him, he "Jumped Out a 16th Story Window". People close to him consider his suicide contrived.

When Forrestal died, he was replaced by General Walter B. Smith.

In December of 1947, PROJECT SIGN was created to acquire as much information as possible about UFOs, their performance characteristics and their purposes. In order to preserve security, liaison between Project Sign and MJ-12 was limited to two (2) individuals within the intelligence division of the Air Material Command whose role was to pass along certain types of information through channels.

Project Sign evolved PROJECT GRUDGE in December 1948. Project Grudge had an overt civilian counterpart named PROJECT BLUE BOOK, with which we are all familiar. Only "Safe" reports were passed to Blue Book.

MJ-12 was originally organized by General George C. Marshall in July 1947 to study the Roswell-Magdalena UFO crash recovery and debris. Admiral Hillenkoetter, director of the CIA from May 1, 1947 until September 1950, decided to activate the "ROBERTSON PANEL", which was designed to monitor civilian UFO study groups that were appearing all over the country. He also joined NICAP in 1956 and was chosen as a member of its board of directors. It was from this position that he was able to act as the MJ-12 "Mole", along with his team of other covert experts.

They were able to steer NICAP in any direction they wanted to go. With the "Flying Saucer Program" under complete control of MJ-12 and with the physical evidence hidden away, General Marshall felt more at ease with this very bizarre situation. These men and their successors have most successfully kept most of the public fooled for at least 39 years or more, including much of the western world, by setting up false experts as real experts and throwing their influence behind them to make their plan work, with considerable success, until now.

Within six (6) months of the Roswell crash on July 2, 1947 and the finding of another crashed UFO at San Augustine Flats near Magdalena, New Mexico on July 3, 1947, a great deal of reorganization of agencies and shuffling of people took place. The main thrust behind the original "Security Lid", and the very reason for its construction, was the analysis and attempted duplication of the technologies of the discs.

The activity is headed up by the following groups:

1. The Research and Development Board (R&DB)
2. Air Force Research and Development (AFRD)
3. The Office of Naval Research (ONR)
4. CIA Office of Scientific Intelligence (CIA-OSI)
5. NSA Office of Scientific Intelligence (NSA-OSI)

No single one of these groups were supposed to know the whole story.

Each group was to know only the parts that MJ-12 allowed them to know. MJ-12 also operates through the various civilian intelligence and investigative groups. The CIA and the FBI are manipulated by MJ-12 to carry out their purposes.

The **NSA** was created in the first place to protect the secret of the recovered flying discs, and eventually got complete control over all communication intelligence.

This control allows the NSA to monitor any individual through mail, telephone, telexes, telegrams, and now through online computers, monitoring private and personal communications as they may desire.

[TOP SECRET - MAJIC](#)

SUBJECT: MAJI

PROJECT: GRUDGE/AQUARIUS: (TS/MAJIC)

Document Control: ECN

Classified By: MJI/MAJI

Declassified on: Exempt

PROJECT AQUARIUS

(TS/ORCON), (Proword):

Grudge contains sixteen (16) volumes of documented information collected from the beginning of the United States Investigation on Unidentified Flying Objects, (UFOs) and Identified Alien Crafts, (IACs). The project was originally established in 1953, by order of President Eisenhower, under control of the CIA and MAJI. In 1960 the project's name was changed from project SIGN to project AQUARIUS. The project was funded by CIA confidential funds (non-appropriated). The project assumed full responsibility for investigation and intelligence of UFOs and/or IACs, after December 1969 when Project Grudge and Blue Book were closed. The purpose of project Aquarius was to collect all scientific, technological, medical and intelligence information from UFO and IAC sightings and contacts with Alien Life Forms. These orderly files of collected information have been used to advance the United States Air Force Space Program (not NASA).

Aquarius is a project which compiled **the history of Alien presence** and their interaction with HOMO SAPIENS upon this planet for the last 25,000 years and culminating with the BASQUE PEOPLE (PAIS BASCO) who live in the mountainous country on the border of France and Spain and the Assyrians (or Syrians, originally from the Sirius Star).

(TS/ORCOM)

The preceding briefing is a historical account of the United States Government's Investigation of Aerial Phenomena, Recovered Alien Aircraft, and contacts with Extraterrestrial Life Forms.

THE PROJECTS UNDER "PROJECT AQUARIUS"

1. (TS/ORCOM) PROJECT PLATO: (Proword: Aquarius)
2. Originally established as part of Project SIGN in 1954, its mission was to *establish Diplomatic Relations with Aliens*. This project was successful when mutually acceptable terms were agreed upon. These terms involved the exchange of technology for secrecy of Alien presence and non-interference in Alien affairs. Aliens agreed to provide MAJI with a list of Human contacts on periodic basis. This project is continuing at a site in New Mexico.
3. (TS/ORCOM) PROJECT SIGMA: (Proword: Aquarius)
4. Originally established as part of Project SIGN in 1954. Became a separate project in 1976. Its mission was to establish communication with the Aliens. This project met with positive success (SIC). In 1959, the United States established primitive communications with Aliens. On April 25, 1964 a USAF Intelligence Officer met with Aliens at Holloman Air Force Base, New Mexico. The contact lasted for approximately three hours, after several attempted methods of communications the Intelligence Officer managed to exchange basic information with the Aliens. This project is continuing at a site in New Mexico.
5. (TS/ORCOM) PROJECT REDUGHT: (Proword: Grudge)
6. Originally established in 1954. Its mission was to test and fly a recovered Alien Aircraft. First attempts resulted in the destruction of the craft and the death of the pilot. This project was resumed in 1972. This project is continuing in Nevada
7. (TS/ORCOM) PROJECT SNOWBIRD: (Proword: Redlight)
8. Originally established in 1954. Its mission was to develop, using conventional technology, and fly a "Flying Saucer" type craft for the public. This project was successful

when a craft was built and flown in front of the PRESS. This project was used to explain UFO sightings and to divert public's attention from project Redlight.

THE 'MAJIC PROJECTS'

1. SIGMA is the project which first established communications with the Aliens and is still responsible for communications.
2. PLATO is the project responsible for Diplomatic Relations with the Aliens. This project secured a formal treaty (illegal under the U.S. Constitution) with the Aliens.
 - o The terms were that the Aliens would give us "our Government" technology and would not interfere in our History. In return we "our Government" agreed to keep their presence on Earth a secret, not to interfere in any way with their actions, and to allow them to abduct humans and animals.
3. The Aliens agreed to furnish MJ-12 with a list of abductees on a periodic basis for Governmental control of their experiments with the abductees.
4. AQUARIUS is the project which compiled the history of the Alien presence and interaction on Earth and the HOMO SAPIENS.
5. GARNET is the project responsible for control of all information and documents regarding the Alien subjects and accountability of their information and documents.
6. PLUTO is a project responsible for evaluating all UFO and IAC information pertaining to Space technology.
7. POUNCE project was formed to recover all downed and/or crashed craft and Aliens. This project provided cover stories and operations to mask the true endeavor, whenever necessary. Covers which have been used were crashed experimental Aircraft, Construction, Mining, etc. This project has been successful and is ongoing today.
8. NRO is the National Recon Organization based at Fort Carson, Colorado. It's responsible for security on all Alien or Alien Spacecraft connected to the projects.
9. DELTA is the designation for the specific arm of NRO which is especially trained and tasked with security of all MAJIC projects. It's a security team and task force from NRO especially trained to provide Alien tasked projects and LUNA security (also has the CODE NAME: "MEN IN BLACK"). This project is still ongoing.
10. BLUE TEAM is the first project responsible for reaction and/or recovery of downed and/or crashed Alien craft and/or Aliens. This was a U.S. Air Force Material Command project.
11. SIGN is the second project responsible for collection of Intelligence and determining whether Alien presence constituted a threat to the U.S. National Security. SIGN absorbed the BLUE TEAM project. This was a U.S. Air Force and CIA project
12. REDLIGHT was the project to test fly recovered Alien craft. This project was postponed after every attempt resulted in the destruction of the craft and death of the pilots. This project was carried out at AREA 51, Groom Lake, (Dreamland) in Nevada. Project Redlight was resumed in 1972. This project has been partially successful. UFO sightings of craft accompanied by Black Helicopters are project Redlight assets. This project is now ongoing at Area 51 in Nevada
13. SNOWBIRD was established as a cover for project Redlight A "Flying Saucer* type craft was built using conventional technology. It was unveiled to the PRESS and flown in public on several occasions. The purpose was to explain accidental sightings or

disclosures of Redlight as having been the Snowbird crafts. This was a very successful disinformation operation. This project is only activated when needed. This deception has not been used for many years. This project is currently in mothballs, until it is needed again.

14. BLUE BOOK was a U.S. Air Force, UFO, and Alien Intelligence collection and disinformation project. This project was terminated and its collected information and duties were absorbed by project Aquarius. A classified report named "Grudge/Blue Book, Report Number 13" is the only significant information derived from the project and is unavailable to the public, (from what I read before from other sources, this Report Number 13, talked about everything inside the Grudge history).

MAJIC'S CONTINGENCY PLANS

In 1949, MJ-12 evolved an initial plan of contingency called MJ-1949-04P/78 that was to make allowance for public disclosure of some data should the necessity present itself.

- General Doolittle made a prediction that one day we would have to reckon with the Aliens and the Grudge/Blue Book, Report Number 13 stated that it appeared that General Doolittle was correct.
- The Grudge/Blue Book Report Number 13 also mentioned that the document stated that many military government personnel and civilians have been Terminated, (murdered without Due Process of Law) when they had attempted to reveal the secret

PLAN A

CONTAIN OR DELAY RELEASE OF INFORMATION - CODE: MAJIC/STR/M 03CCPN24:

This plan called for the use of MAJESTIC TWELVE as a disinformation ploy to delay and confuse the release of information should anyone get close to the truth. It was selected because the similarity of spelling and the similarity to MJ-12.

It was designed to confuse memory and to result in a fruitless search for material which did not exist (i.e. William Moore's Documents?)

PLAN B

SHOULD THE INFORMATION BECOME PUBLIC OR SHOULD THE ALIENS TAKE OVER:

This plan called for a public announcement that a terrorist group had entered the United States with an Atomic weapon. It would be announced that the terrorists planned to detonate the weapon in a major city. Martial Law would be declared and all persons with implants would be activated by the Aliens.

That person, in this specific case, would be rounded up by MAJIC along with all dissidents and would be placed into concentration camps. The PRESS, the Radio and TV would be nationalized and controlled. Anyone attempting to resist would be arrested or killed.

MAJIC'S SECRET WEAPONS AGAINST ALIENS

Although better weapons are being developed every day, the following are a few of the originals

created.

- GABRIEL is a project to develop a High Frequency pulsed sound generating weapon. It was said that this weapon would be effective against the Alien crafts and their Beam weapons. Specifications about the GABRIEL project shows *high frequency microwave projections* included.
- JOSHUA is a project to develop a Low Frequency pulsed sound generating weapon. The weapon was developed and assembled at Ling Tempco Vought in Anaheim, California It was described as being able to totally level any man made structure from a distance of two (2) miles. It was tested at White Sands Proving Grounds. It was developed between 1975 and 1978. It is a long horn shaped device connected to a computer and amplifiers. Ling Tempco Vought (LTV) has since moved from its Anaheim Facility which was near the Grand Hotel across the street from Disneyland. Specifications about the JOSHUA project show low frequency generated with microwave projection included.
- EXCALIBUR is a weapon to destroy the alien underground bases. It is to be a missile capable of penetrating 1,000 meters of Tufa/Hard packed soil, such as that found in New Mexico with no operational damage. Missile apogee not to exceed 30,000 feet Above Ground Level (AGL) and impact must not deviate in excess of 50 meters from designated target. The device will carry a one (1) to ten (10) Megaton Nuclear Warhead. The secret for a self-contained missile 'drill' a vertical shaft over 1,000 meters deep consists in a energosintetizer macrowave deflector in the "Missile Warhead".
- OBS - MAJIC has five (5) other major weapons to use against Aliens but I don't have the data on or about these weapons yet

INFO FROM GRUDGE/BLUE BOOK REPORT 13

- EBE is the name or designation given to the live Alien captured at the 1947 Roswell, New Mexico crash. He died in captivity. EBE means Extraterrestrial Biological Entity.
- KRLL was the first Alien Ambassador to the United States of America
- GUESTS were Aliens exchanged for Humans who gave us the balance of the YELLOW BOOK At the onset in 1972 there were only three (3) left alive, now we have around 4,000. They were called Alien Life Forms (ALFs) or OBS. They have a big tendency to UE.
- YELLOW BOOK is all that we know about Alien technology, culture and their history.
- RELIGION - The Aliens believe in a *Universal Cosmic God*. The Aliens claim that MEN are Hybrids who were created by them. They claim ail religion was created by them to hasten the formation of a Civilized Culture and to control the Human Race. They claim that JESUS was a product of their efforts. The Aliens have furnished proof of their claims and have a "device" that allows them to show audibly and visually any part of History that they or we wish to see.
- ALIEN BASES exist in the four comer areas of Utah, Colorado, New Mexico and Arizona Six bases were described in 1972, all on Indian Reservations, and all in the four corner area. The base near Dulce was one of them, also bases at California, Nevada, Texas,

Florida, Maine, Georgia and Alaska.

- CRAFT RECOVERIES - The documents stated that many craft had been recovered. The early ones from Roswell, Aztec, Roswell again, Texas, Mexico and other places, which will be discussed later.
- ABDUCTIONS were occurring long before 1972, early civilizations refer to these incidents. The document stated that humans and animals were being abducted and or mutilated. Many vanished without a trace. They were taking sperm and OVA samples, tissues, performed surgical operations, implanted a spherical device, (40 to 50 microns in size near the optic nerve in the brain) and all attempts to remove the device have resulted in the death of the patient. The document estimated that one (1) in every 40 people had been implanted. This implant was said to give the Aliens total control of the Human.

OTHER MAJIC - ALIENS TIPS FROM REPORT 13

SRD/28 CODE: ABRAMA 33A/C

- We confirmed in 1989, the existence of Alien crafts at a hangar on Edwards Air Force Base. The hangar is at North end of the base. It has been guarded by non-Edward's personnel, who are NRO-DELTA personnel. The guards wear a badge that is red with a black triangle on the face of the badge. No one was allowed near the hangar without this badge.
- The NRO-DELTA personnel are no longer guarding the hangar, Edwards security forces are guarding it now, and they are instructed to check the hangar each hour and report the status NRO. In addition, they have been instructed never to enter the hangar, even if it has been broken into. The hangar is still locked and no one is allowed inside without special authorization from NRO/DELTA.
- We also have confirmed the existence of Alien Materials at another Special hangar at Edward's AFB.
- The badge insignias that are on some Alien crafts and Alien Flags, is called a TRILATERAL INSIGNIA (TRIADE).

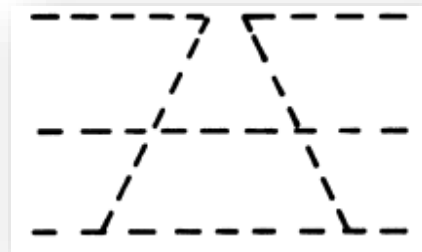
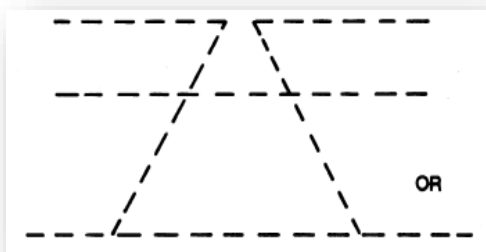

Found on some Spacecraft

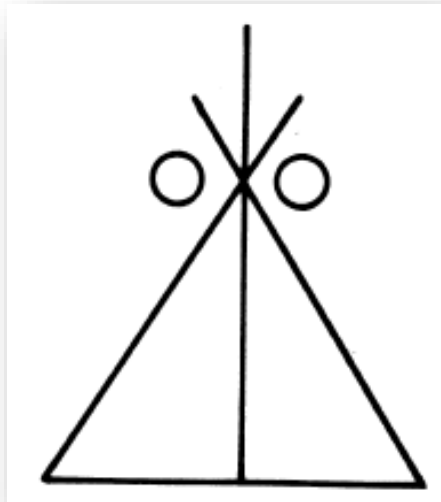
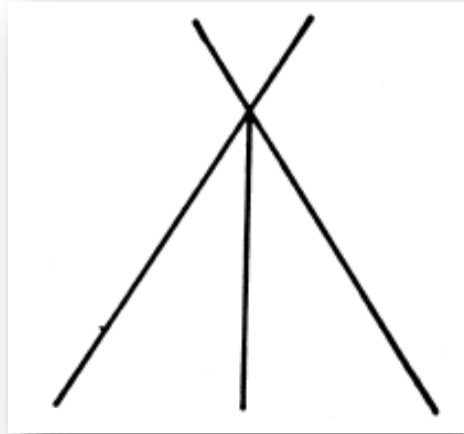

Marks bases and Landing sites

This symbol is visible, "Only when viewed from Directly Overhead"

This symbol is found on some Regelian's Spacecraft and their Uniforms

- LUNA-2 - Code name for the location of the second most important underground Rigelian base in New Mexico. The base is Alien controlled and NRO, DELTA, and Alien protected. Luna is ongoing.

- FAR SIDE OF THE MOON - Is the term used in reference to inside LUNA-2. The LUNA-2 underground base, UFOlogists and some other various people who have stumbled upon this term have a misunderstanding and believed that it was a reference to LUNA-1, the moon base.

NSA Security System

The National Security Agency, (NSA) was created to protect the secretly recovered flying disks, and eventually got complete control over all Communication Intelligence.

This control allows the NSA to monitor any individual through the mail, telephone, telex, faxes, telegrams, and now through on-line computer, monitoring private and personal communications as they choose.

In fact, the present day NSA is the current main expression of MJ-12 and PI-40 pertaining to the Flying Saucer Programs. Vast amounts of disinformation are spread throughout the UFO research field. Any witnesses to any aspect of the programs have their lives monitored in every detail, for each has signed a security catch.

For people who have worked in the program, including military members, breaking that oath could have anyone of the following direct consequences:

- A verbal warning accompanied by a review of the security oath.
- A stronger warning, sometimes accompanied by a brow-beating and intimidation.
- Psychologically working on an individual to bring on depression that will lead to suicide.
- Murder of the person, which is made to appear as suicide or an accident.
- Strange and sudden accidents, always fatal.
- Confinement in a special Detention Center.
- Confinement in an Insane Asylum, where they are treated by mind-control and deprogramming techniques. The individuals are later released with changed personalities, identities, and altered memories.
- Bringing the individual into the inside, where he or she is employed and works for them and where he or she can be watched. This is usually in closed facilities with little contact with the outside world. Underground facilities are the usual place for this.

Any individual who they perceive to be too close to the truth, will be treated in the same manner.

MJ-12/NSA will go to any length to preserve and protect the ultimate secret, as we will see later, the characteristics of what this ultimate secret would turn out to be would change drastically for it was something even MJ-12/NSA could not predict, actual contact with Alien groups.

How the actual contact between the government and Aliens was initially made is not known at this time, but the Government was made aware that it could be done by an Alien using the right equipment.



2. ABOUT ALIENS ON EARTH - CODE: OMNIDATA

IRS-28 - CODE: IRWING/7 - MAT/ORM, 26.01/AB/7

- Facts About Aliens on Earth (1)
- Main Important UFO Crashes, Under Ultra-Secret Cover-ups
- Extraterrestrial Classifications
- Alien Presence on Earth

After all these years of research we have compiled these major facts about Aliens on Earth.

- Alien crafts from other worlds have crashed on Earth.
- Alien crafts are from both Ultra-Dimensional sources and sources within this Dimension.
- Early U.S. Government efforts at acquiring technologies were successful.
- The U.S. Government has had live Alien hostages at some point in time.
- The U.S. Government has conducted autopsies on Alien cadavers.
- U.S. Intelligence Agencies and Security Agencies are involved in the cover-up of facts pertaining to the situation.
- People have been and are currently being abducted, mutilated, murdered and kidnapped as a result of the UFO situation.
- There is a current Alien presence on this planet among us that controls different elements of our society.
- Alien forces maintain bases on Earth and on the Moon.
- The U.S. Government has had a working relationship with Alien Forces for some time, with the express purpose of gaining technology in gravitational propulsion, beam weaponry and mind control.
- Millions of cattle have been killed in the process of acquiring biological materials. Both Aliens and the U.S. Government are responsible for mutilations, but for different reasons.
- We live in a multi-dimensional world that is overlapped and visited by Aliens/Entities from other dimensions. Many of those entities are hostile, and many are not hostile.
- The basis for our genetic development and religions lies in intervention by non-terrestrial and terrestrial forces.
- The truth about our actual technology far exceeds that perceived by the Public.
- The United States Space program of today is a cover operation that exists for public

relations purposes.

- People are being actively killed in order to suppress the facts about the situation. The CIA and the NSA are involved so deeply that exposure would cause collapse of their overt structure.
- Facts indicate Alien presence within 5 to 10 thousand years.
- Our civilization is one of many that have existed in the last billion years, "Milky Way time period"
- Alien Psychology (see information in the following pages)
- The Metagene factor (see information in the following pages).
-

UFO CRASHES UNDER ULTRA-SECRET COVER-UPS

Of course there were other crashes, however, I was not sent on those investigations. Some of the other confirmed crashes occurred in Europe, Africa, China, Soviet Union, and Australia, just to name a few.

NEW MEXICO, USA Roswell San Augustine Flats Aztec	1947-1948	CAUSE: Affected by a new experimental Radar Type NOTE: This U.S. Radar is the basis to the 'JOSHUA and GABRIEL' defense projects.
CALIFORNIA, Desert, USA	1952	CAUSE: Unknown
MEXICO, Sonora Desert	1955	CAUSE: Unknown
FLORIDA, Everglades, USA	1959	CAUSE: Affected by Radar.
TEXAS, Dayton, USA	1961	CAUSE: Unknown
BRAZIL, Mato Grosso	1966	CAUSE: Unknown
URUGUAY, Salto	1970	CAUSE: Unknown
BRAZIL, Amazon	1976	CAUSE: Unknown
MEXICO, Gulf of Mexico	1979	CAUSE: Unknown
ARGENTINA, Andes	1979	CAUSE: Unknown
ALASKA, Fairbanks, USA	1981	CAUSE: UFO Malfunction

With possible other unconfirmed crashes occurring in the Philippines and New Zealand.

EXTRATERRESTRIAL CLASSIFICATIONS

GUESTS	Invited Aliens, with authorization of the U.S. Government to stay on Earth.
VISITORS	Aliens who have come to earth for unknown missions.

PRISONERS	Captured Aliens by the U.S. Government and/or other Governments.
RESEARCHERS	Aliens who have come to Earth for Scientific Motives.
INTRUDERS OR MALEVOLENTS	Aliens who are dangerous for our civilization because they don't respect our society.
NEUTRALS	Aliens who just observe our civilization and never interfere with us.
COLONIZERS	Small groups of Aliens who have decided to <u>live among us</u>, (like us).
INTERACTORS	Small groups of Aliens who have decided to interfere with our History, making changes when its possible.

ALIEN PRESENCE ON EARTH

There are some one hundred sixty (160) or more known types of Aliens visiting our world (Earth) at the present time, these are the most commonly seen types:

1. Greys, type one (1) - The Rigelians from the Rigel Star system and are approximately four (4) feet tall, with a large head containing large slanted eyes, who worship technology and DON'T CARE ABOUT US. The type popularized in the "[Communion](#)" book by Strieber. They need vital secretions for their survival, which they are getting from us (earthlings).
2. [Greys, type two \(2\) - Come from the Zeta Reticuli 1 & 2 solar systems](#). Same general appearance as a type one (1), although they have a different finger arrangement and a slightly different face. These Greys are more sophisticated than the type ones (1). They possess a degree of common sense and are somewhat passive. They don't require the secretions that the type ones (1) due.
3. Greys, type three (3) - Simple cloning form of types one and two above. Their lips are thinner (or no lips). They are subservient to the type one and two Greys above.
4. Nordics, Blondes, Swedes - Known by any of these names. They are similar to us. Blonde hair, blue eyes (some have dark hair and brown eyes and they're shorter in height). They will not break the law of non-interference to help us. They will only intervene if the Greys activity were to affect us directly.

5. Nordic Clones - They appear similar to us but with a grey tinge to their skin. These Nordics are controlled drones, created by the Greys, type ones (1).
6. Intra-Dimensional (Not Para-Terrestrial) - Entities that can assume a variety of shapes. Basically of a peaceful nature.
7. Short Humanoids - One and a half to two and a half feet tall, with skin bluish in color. They are seen quite frequently in Mexico near Chihuahua
8. Hairy Dwarfs (Orange) - They are four (4) feet tall and weigh about thirty five (35) pounds. Their hair is the color of red. They seem to be neutral and respect intelligent life forms.
9. Very Tall Race - They look like us but are seven to eight feet tall. They are united with the Swedes.
10. Men In Black (MIBs) - They are not from the Delta or NRO division of the government. They are oriental or olive-skinned, their eyes are sensitive to light and have vertical pupils. They have very pale skin on some types. They do not conform easily to our social patterns. Usually they wear black clothes (sometimes all white or grey clothes), wear sunglasses and drive black cars. In groups they all dress alike. Sometimes time-disoriented. They cannot handle a psychological "curve ball" or interruption to their plans. They very often intimidate UFO witnesses and impersonate government officials. Equivalent of our CIA from another Galaxy.

CATTLE MUTILATIONS

- My General Personal Observations
- Human Reasons for the Mutilations
- Alien Reasons for the Mutilations
- Black Helicopter Involvement in Mutilations

General Chronology

In the middle of 1963, a series of livestock attacks occurred in Haskell County, Texas. In a typical case, an Angus Bull was found with its throat slashed and a saucer-sized wound in its stomach. The local population attributed the attacks to a wild beast of some sort, a so called vanishing varmint. As it continued throughout the Haskell County, the blood-luster assumed somewhat more mythic proportions and a new name destined to endure, "The Haskell Rascal".

Throughout the following decade, there would be sporadic reports of similar attacks on livestock. In 1967 the most prominent of these infrequent reports was the mutilation death of Snippy the horse in Southern Colorado, which at the same time were accompanied by accounts of UFOs and Unidentified Helicopters. In 1978, the attacks increased, and by 1979, numerous livestock mutilations were occurring in Canada, primarily in Alberta and Saskatchewan.

Attacks in the United States leveled off for a while, but in 1980, there was an increase in activity again. Since that year, mutilations have been reported less frequently, though this may be due in part to an increased reluctance to report mutilations on the part of ranchers and farmers. The mutilations still continue today, and over ten thousand animals have died in the United States alone, although the mutilations have been occurring worldwide, the circumstances surrounding the mutilations are always the same.

A drug connection to these mutilations may be found inside the "YELLOW BOOK". We found that, as the Terrain Scientist learned about Longevity, (Secret of long life) the main basis for longevity was the capacity of human cells to recuperate. Anyone will grow old when their cells can't be restored and they start a process of deterioration and die. The secret of longevity is the restoration of the cells.

This can be done using:

- Altered Adrenalin,
- Altered Coradrenalin,
- Cordrazine or Cortropinex, (sometimes use only Formazine and Hyronalinx, read "The Lost Chapters" for additional information on these and more drugs).

All of these drugs have a base in Adrenalin, which is produced in the human brain. During the 60's the scientists discovered that they can be synthesized from the medullary portion of the adrenal gland of the cattle. They need big quantities in order to synthesize a small portion of the mentioned drugs above.

Of course, human scientist try to discover new applications and new synthesized drugs for recuperation of the cells, especially brain cells, and restoration to the human tissues and increasing the psychic and physical human skills.

[My General Personal Observations](#)

Any investigation which intends to probe the systematic occurrences of the mutilation attacks upon livestock and other animals must include within its preview certain factors which may or may not be directly related to the acts of mutilation themselves. These mutilations, the killing and furtive removal of external or internal parts, have been directed at literally thousands of animals, primarily livestock, since the 1960's.

The surgery on these animals is primarily conducted with uncanny precision, suggesting the use of a highly sophisticated implements and techniques. The numbing and persistent regularity of the mutilations and the seemingly casual disposal of the useless carcasses all hints at extreme confidence, even arrogant, of the mutilators.

It is an arrogance which appears to be justified by the freedom and impunity with these acts have been carried out.

- Human Reasons for the Mutilations
- These events, or the discussion of them, is just the precursor to the actual revelations of what is behind the mutilations: Alien acquisition of biological material for their own use. To discuss this in a logical and sequential manner, we must review what has been really

happening right under our noses. The direct interaction with Extraterrestrial Biological Entities (EBEs). To discuss that, we must attempt to start at the beginning with what we know to be true.

- Alien Reasons for the Mutilations
- The main interest to Aliens, (we talk specifically about Rigelians) is breeding, with humans of course. They need the cattle's tissues because they have the same carron cells as the human being at Genetic levels. All incisions would be made by Replicas, Clones, or Androids. They can send teams and take the material they need, and it doesn't matter where or how much. If they need it, they just take it.
- This means that Rigelians are not Vampires, or that they need it for survival, but just immoral scientists that need material for experiments.



[Black Helicopter Involvement in Mutilations](#)

The pertinence of a specific element of the problem is shortly revealed in the course of any thorough investigation into the mutilations. We refer to a appearance of unmarked and otherwise unidentified helicopters within a spatial and temporal proximity of animal mutilation sites. The occurrence of the two has been persistent enough to supersede coincidence.

These mystery helicopters are almost always without identifying markings, or markings may appear to have been painted over or covered with something. The helicopters are frequently reported flying at abnormal, unsafe or illegal altitudes. They may shy away if witnesses or law officers try to approach.

There are several accounts of aggressive behavior on the part of the helicopter occupants, with witnesses chased, buzzed, hovered-over or even fired upon. At times these choppers appear very near mutilation sites, even hovering over a pasture where a mutilated carcass is later found. They may be observed shortly before or after mutilations occur, or within days of a mutilation.

The intention here is merely to stress that the mystery helicopters did not develop concurrently with the animal mutilations themselves. Such helicopters, unmarked, flying at low levels, soundless, or sounding like helicopters, have been reported for years, and have been linked to an even more widespread phenomenon, the "Phantom" fixed wing aircraft. The answer could be a combination of the above explanations.

There also has been speculation that they are involved in biological experiments with chemical or biological warfare or the geo-botanical pursuit of petroleum and mineral deposits. On one occasion, an Army Standard Type Scalpel was found at a mutilation site. Since the disks have been mostly involved with the mutilations, it is thought that this was a diversionary event.

In fact, both, Alien and the U.S. Government are responsible for mutilations, but for different reasons.



THE ANTARIAN CONNECTION

CODE: OMNICORD

Time and UFOs

Time is one of the most important aspects of the UFO thing. It plays a strange, but significant role. Part of the answer may not lie in the Stars but in the clock ticking in front of you.

The planet Earth exists in three dimensions; we can move in many directions within these dimensions. Space does not exist except when we make it exist. To us, the distance between atoms in our matter is so minute that it can only be calculated with hypothetical measurements, yet, if we lived on an atom, and our size was relative to its size, the distance to the next atom would seem awesome.

There is another Earth's man-made measurement called time. Unlike the other three dimensions, time has us seemingly trapped. Time becomes very real to us, and it appears that we couldn't live without it. Yet time doesn't really exist at all. This moment exists to us, does this mean the same moment is being shared by other planets, in other galaxies? "Not really".

The UFO phenomenon does seem to be controlled, this means it does follow intelligent patterns. If the objects themselves are manifestations of higher energies, then something has to manipulate those energies somehow and reduce them to the visible frequencies, for human patterns, but they take forms which seem physical and real to us, and they carry out actions which seem to be intelligent.

Thus, we arrive at the source, the source has to be a form of intelligent energy operating at the highest possible point of the Frequency Spectrum. If such an energy exists at all, it might permeate the Universe and maintain equal control of each component part. Because of its very high frequency, so high that the energy particles are virtually standing still, the source has no need to replenish itself in any way that would be acceptable to our environmental sciences. It could actually create and destroy matter by manipulating the lower energies. It would be timeless, because it exists beyond all time fields. It would be infinite because it is not confined by Three-Dimensional Space.

Perhaps if we were in a pure energy state, each particle of energy would itself serve as a synapse, and information could be stored by a slight alteration in frequency. All the memory fragments of a rose, for example, would be recorded at one frequency, and the whole energy form could tune into that memory by adjusting frequencies, as we might adjust a radio receiver, (well... well... well... where have we heard of this before!). In other words, no complex circuitry would be required, and no physical body would be necessary either.

The energy patterns would not need material form, it instead would permeate the entire Universe, (Universe... interesting small point of view of a gigantic concept of the reality of the MULTIVERSE). It could surround you completely at this very moment and be aware of all the feeble impulses of low energy passing through your brain. If it were so desired, it would control those pulses and thus control your thoughts.

Man has always been aware of this intelligent energy or force, he has always worshipped it, i.e. God, Jesus, or the Universal Being, etc.

1. Our first conclusion is that some UFOs originate from beyond our own time frame or time cycle.
2. Our second conclusion is that the source has total foreknowledge of human events and even individual lives, since time and space are not absolutes.

These two conclusions are compatible.

It is that all human events occur simultaneously when viewed by a greater intelligence. If a greater intelligence wants to communicate with a lower form, all kinds of problems are presented. The communication must be conducted in a manner which will be meaningful and understandable to the lower life form, an acceptable frame of reference must be found and utilized.

The UFO phenomenon is frequently reflective; that is, the observed manifestations seem to be deliberately tailored and adjusted to the individual beliefs and attitudes of the witnesses. Contactees are given information which, in most cases, conforms to their beliefs. UFO researchers who concentrate on one particular aspect or theory find themselves inundated with seemingly reliable reports which tend to substantiate that theory (?!).

Soviet researchers' extensive experiences with this reflective factor led them to carry out weird experiments which confirmed that a large part of the reported data is engineered and deliberately false. The witnesses are not the perpetrators, but merely the victims.

The apparent purpose of all this false data is multifold, much of this is meant to create confusion and diversion. Some of it has served to support certain beliefs which were erroneous but which would serve as a stepping stone to the higher, more complex truth. Whole generations have come and gone, happily believing in the false data, unaware that they were mere links in the chain.

If it were all understood too soon, we might crumble under the weight of the truth.

The planet Earth is covered with windows, (corridors, tunnels, and/or gates) into those other unseen worlds. We have the instruments to detect them, and if we decide to use them, we would find that these windows are the focal point for Super High-Frequency Waves, the rays of ancient lore. These rays might come from Orion or the Pleiades Star System as the Terran's ancients claimed, or they might be part of the great force that emanates throughout this Universe, perhaps from the Antares Star System.

The UFOs have given to the Terrans the evidence that such rays exist. Now, slowly, we are being told why.

Observers from the Antares Star System are watching the Terrans and they know the guidelines for "Warp Zones" come from the center of the Antares Star System and draw tunnels for several main points of this and other Universes. They are "Gates" for several travelers from all Universes. Of course there are many more focus points, when other rays come from around the Universe.

CROP CIRCLES PHENOMENA

CODE: SEC

Crop Phenomena: Circles Affair

The better way to understand the so called crop phenomena, (circles that appear in fields) is by the following example:



We, the people of Earth, exist at the 3rd dimension because our atoms have a specific frequency which makes us able to exist at the 3rd dimension. This specific frequency is stable enough for all our lifetime. One quick idea of dimensions tells us:

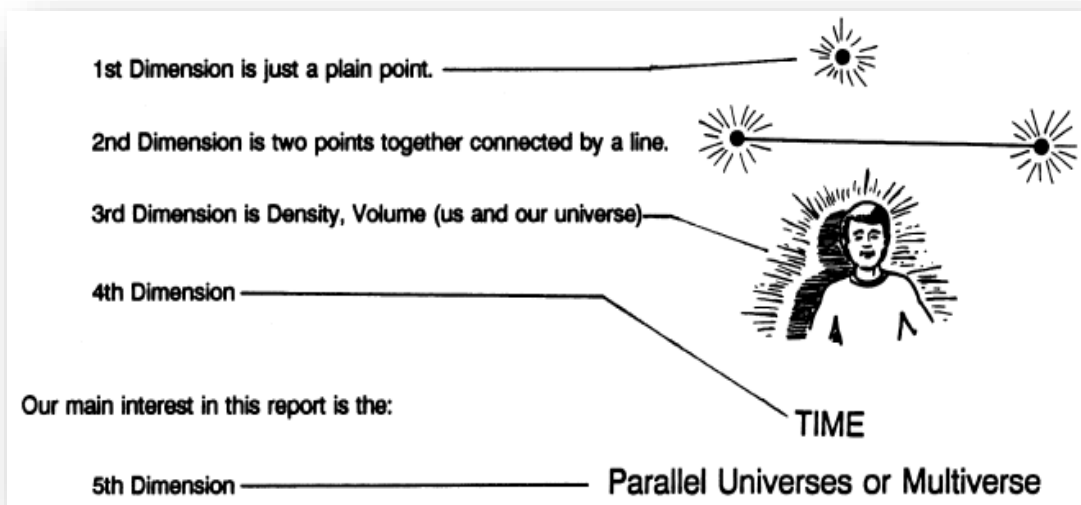

That's the whole idea behind the multiverse concept, not just one universe but an infinite number of parallel universes. Using math to make a simplification of this concept tells us that there are no limits of the higher or lower number that exist. It's impossible to figure these numbers like it's impossible to figure the extension of possibilities of the [Multiverse](#).



If we are capable of accelerating or decelerating the frequencies to make us able to exist in the 3rd Dimension, we can jump to the 5th Dimension, or the Multiverse.

To understand this idea better, try to think that all this is just like listening to a radio set. When you listen to a radio set, you are listening to a single radio station, on a single frequency, by changing to a different radio station, you have to change to a different frequency.

This is accomplished by the frequency tuning dial on the front of the radio set, but because you are listening to a single radio station, on a single frequency, does not mean that other stations on other frequencies do not exist, right.

Same thing with the other universes from the Multiverse, they're at other different frequencies than we are and we just don't know it yet.

Why are we in the 3rd Dimension and they are in the 5th Dimension? Why not the reverse? Simple, "it's based on perspective, they see us as their 5th Dimension and we see them as our 5th Dimension". Again, it is just a question of perspective.

The other dimensional travelers come to our dimension by using some process of acceleration of particles and give them the capability of jumping between dimensions, but why did they select England first, and then why the fields?

The answer is, England had all of the right conditions for one of several civilizations that exist in the Multiverse to be able to contact us through crop circles. All answers of how they were able to accomplish this task lie in a vast prehistoric energy circuit.

England has a complex web of energy running in inter-links with tumuli, ancient graves and stone circles or henges, and all of the sites, henges, mounds and stone circles were constructed in relation to underground water linked with energy lines. This creates some sort of natural electromagnetic force field created by the water, combined with the presence of underground quartz deposits.

Also, the lunar gravitational effects on the water, land mass and the buildup of an electrical magnetic charge from the quartz produces a periodic energy discharge.

The energy bolts give the necessary conditions for these other dimensional civilizations to be able to start experimenting with our universe and/or planet.

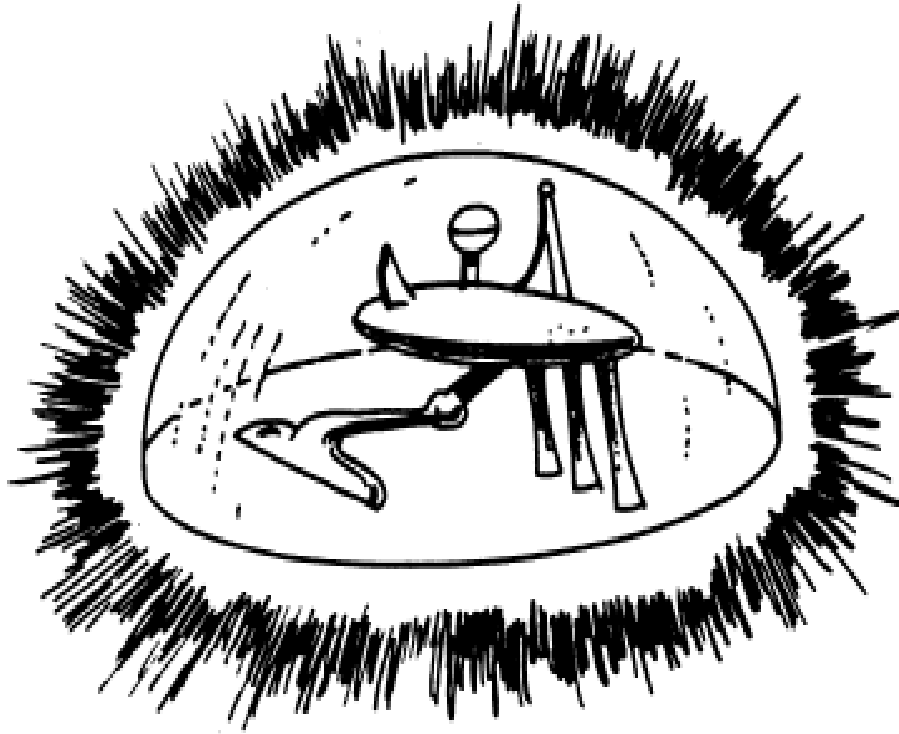

They have started to send probes here, in order to know more about the natural conditions of our universe and planet. The probes are limited to one specific semidome of energy, a circle, in a field where they have scanned the energy bolt

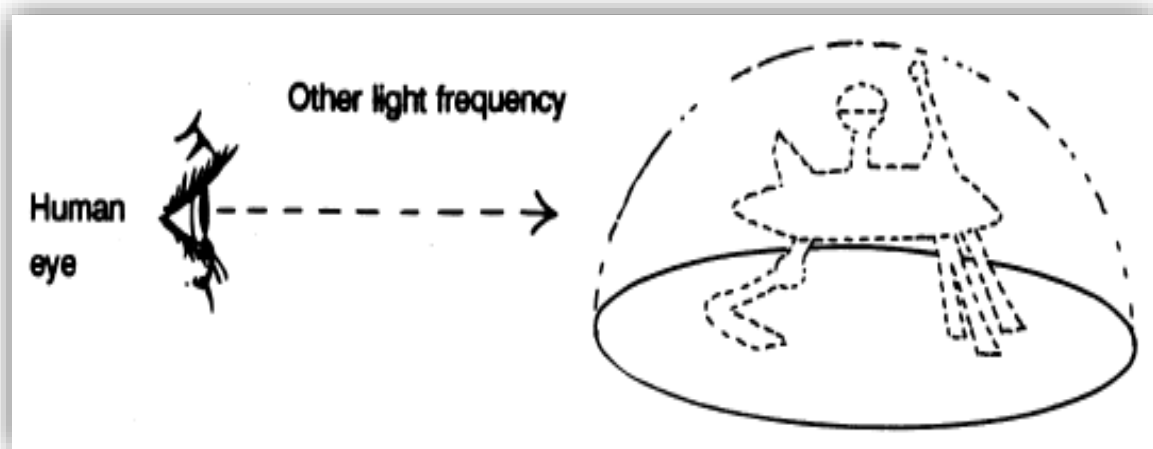

In the above sketch, our eyes wouldn't be able to see the probe at that moment, because of our visual limitation, of not being able to see the frequencies between the frequencies of infrared and ultraviolet. Of course if you were able to detect the device using infrared or ultraviolet equipment, then you would be able to see it.

THE DULCE BASE

CODE: J.B. III



The following material comes from people who know the Dulce underground base exists. They are people who worked in the labs; abductees taken to the base; people who assisted in the construction; intelligence personnel, (NSA, CIA; etc.) and some specific UFO inner Earth researchers.

This information is meant for those who are seriously interested in the Dulce base.

For your own protection, be advised to 'Use Caution' while investigating this complex. An ongoing investigation made by J.B. III, (Code: SR24.3B7).

[The Dulce Base](#)

This facility is a genetics lab and is connected to Los Alamos, via Tube-Shuttle. Part of their research is related to the genetic effects of radiation, (Mutation and Human Genetics). Its research also includes other Intelligent Species as well, (Alien Biological Life Form "Entities"). In the revised September 1950 edition of *The Effects of Atomic Weapons*, prepared for and in cooperation with the U.S. Department of Defense and The U.S. Atomic Energy Commission, under the direction of the Los Alamos Scientific Laboratory, we read about how complete underground placement of bases is desirable.

On page #381: "There are apparently no fundamental difficulties in construction and operating underground various types of important facilities. Such facilities may be placed in a suitable existing mine or a site may be excavated for the purpose".

[Caught in the Game](#)

Centuries ago, surface people, some say the Illuminati, entered into a pact with an "Alien Nation", hidden within the Earth. The U.S. Government, in 1933, agreed to trade animals and humans in exchange for high-tech knowledge, and to allow them to use undisturbed underground bases, in the western USA. A special group was formed to deal with the Alien beings. In the 1940's, "Alien Life Forms" (ALFs) began shifting their focus of operations, from Central and South America to the United States.

The continental divide is vital to these specific entities. Part of this has to do with magnetic substrata rock and high energy plasma states, (see: *Beyond the Four Dimensions*, reconciling physics, parapsychology and UFOs, by Karl Brunstein, and also: *Nuclear Evolution*, discovery of the rainbow bodi/aura by Christopher Hills).

- This area has a very high concentration of lightning activity; underground waterways and cavern systems, fields of atmospheric IONS, etc.

[Whose Planet Is this?](#)

These specific Aliens consider themselves Native Terrans. They are an Ancient race, descendants of a reptilian Humanoid species which cross-bred with some of the more primitive Uni-Terrestrial survivors. They are untrustworthy manipulator mercenary agents from another Extraterrestrial culture, "The Draco's" who are returning to Earth, which was their ancient outpost before the coming of the original Uni-Terrestrials, to try to use it as a staging area, which is not easy at all, because it causes all the other one hundred seventy (170) Alien species to want their share of the Metagene secrets.

But, these Alien cultures are in conflict over whose agenda will be followed for this planet. All the while mind control is being used to keep humans in place, artificially of course, especially since the forties. The Dulce complex is a joint U.S. Government and Alien base.

It was not the first one built with the Aliens and others are located in Colorado, Nevada, Arizona, Alaska, etc.

[The Secret Activity - About Dulce area](#)

Troops went in and out of there every summer, starting in 1947. The natives do recall that they also built a road, right in front of the people of Dulce and trucks went in and out for a long period. That road was later blocked and destroyed. The signs on the trucks were "Smith Corp." out of Pagosa Springs, Colorado.

No such corporation exists now, no records exist, and I believe the base, at least the first one was being built then undercover of a lumbering project, who never hauled any logs at all, only big equipment

[R&D and the Military Industrial Complex](#)

The Rand Corp. became involved by doing a study, for the base on geology around the nearby lakes. Most of the lakes near Dulce were made, via Government Grants for the Indians, as such a completed Grant, the NAVAJO Dam is a main source for conventional electrical power, with the second source in ELVADO (which is also, an underground entrance to the Dulce base).

NOTE: If Rand is the mother of "Think Tanks", then the "Ford Foundation" must be considered the Father.

Rands secrecy is not confined to reports, but on occasion extends to conferences and meetings. On page #645 of the Project Rand, proceedings of the Deep Underground Construction Symposium of March 1959, we read:

"Just as airplanes, ships and automobiles have given man mastery of the surface of the Earth, tunnel, boring machines, will give him access to the subterranean world."

NOTE: The September 1983 Issue of OMNI, page 80, has a color drawing of "The Subterrene", the Los Alamos Nuclear powered tunnel machine, that burrow through the rock, deep underground, by heating whatever stone it encounters into molten rock, (Magma), which cools after the subterrene machine has moved on. The result is a tunnel with a smooth, glazed lining.

These underground tubes are used by electro-magnetically powered sub-shuttle vehicles, which can travel at great speeds. They connect the so-called "Hidden Empire" sub-city complexes. Also, the top secret project code-named "NOAH'S ARK", uses the tube shuttles in connection with a system of over one hundred (100) bunkers and bolt holes, which have been established at various places on Earth.

They built the same type of subterranean tunnels at the ultra-top secret Moon and Mars bases as well. Many of these underground cities are complete with streets, sidewalks, lakes, small electrical cars, buildings, offices and shopping malls.

There were over six hundred fifty (650) attendees to the 1959 Rand Symposium, most were representatives of the Corporate Industrial State, like:

- The General Electric Company
- Hughes Aircraft Company
- Sandia Corporation
- Walsh Construction Company
- Colorado School of Mines
- AT&T
- Northrop Corporation
- Stanford Research Institute
- The Bechtel Corporation
- Etc.

Bechtel is a super-secret international corporation octopus, founded in 1898. Some say the firm now is really a "Shadow Government", a working arm of the CIA. It is the largest construction and engineering outfit, in the U.S.A., the world, and some say, beyond. The most important posts in USA. Government are held by former Bechtel officers.

They are part of "The Web", an interconnected control system, which links the Trilateralist Plans, the C.F.R., the Orders of Illuminism, (cult of the All-Seeing Eye) and other interlocking groups.

[Surviving the Future](#)

The Dulce facility consists of a central hub, the security section, and also some photo labs. The deeper you go, the stronger the security. This is a Multi-Levelled complex, with over 3,000 cameras at various high security locations, i.e. exits and labs.

There are over one hundred (100) secret exits near and around Dulce. Many around Archuleta Mesa, others to the south around Dulce lake and even as far East as Lindrith.

NOTE: Deep sections of the complex connect into natural cavern system. A person who worked at the Base (CR-24/ZM 35-File IV), who had an "Ultra 7-B" clearance reports the following:

"There may be more than seven levels, but I only know of seven. Most of the Aliens are on levels 5, 6, and 7. Alien housing is on level five (5)."

Transamerican Underground Sub-shuttle System, (TJLU.S.S.)



[Overt and Covert Research within Dulce](#)

As U.S. Energy Secretary, John Herrington named the Lawrence Berkeley Laboratory and New Mexico's Los Alamos National Laboratory to house new advanced genetic research centers as part of a project to decipher the [Human Genome](#). The Genome holds the genetically coded instructions that guide the transformation of a single cell, a fertilized egg, into a biological being. The Human Genome Project may well have the greatest direct impact on humanity of any scientific initiative before us today", said David Shirley, Director of the Berkeley Laboratory.

Covertly, this research has been going on for years, at Dulce labs.

Level #6, at Dulce, is privately called "Nightmare Hair," it holds the Genetic Labs. Reports from workers, (CR-24/ZM 52-Files VII), who have seen bizarre experimentation, are as follows:

"I have seen multi-legged humans that look like half-human, half-octopus. Also reptilian-humans, and furry creatures that have hands like humans and cries like a baby, it mimics human words, and also huge mixture of lizard humans in cages."

There are fish, seals, birds and mice that can barely be considered those species. There are several cages, and vats of winged humanoids, grotesque Bat like creatures about three and a half to seven feet tall. Gargoyle-like beings and Draco-Reptoids.

Level #7 is worse, row after row of several humans and humanoids, (hundreds, perhaps thousands) in cold storage. Here too are embryo storage vats of humanoids, in various stages of development.

"I frequently encountered humans in cages, usually dazed or drugged, but sometimes they cried and begged for help. We were told they were hopelessly insane and involved in high risk drug

tests to cure insanity. At the beginning, we were told never try to speak to them at all, at the end we believed that story."

Finally, in 1978, a small group of workers discovered the truth. It began the Dulce Wars, and a secret resistance Unit was formed.

NOTE: There are over 18,000 Aliens at the Dulce complex at this time.

In late 1979, there was a confrontation, over weapons, a lot of scientists and military personnel were killed. The base was closed for a while, but now, it is currently active again.

NOTES:

1. Human and animal abductions, for their blood and other parts, slowed in the mkJ-1980's, when the Livermore Berkeley Labs began production of artificial blood for Dulce and its sister complexes.
2. About the confrontation, Human and Alien at Dulce, eighty (82) people were killed between scientists and the National Recon Group, the DELTA GROUP, which is responsible for security of all Alien connected projects. Also, there were hundreds of other wounded people and 132 dead aliens.



This type of entity is one that abductees and contactees have seen in underground breeding facilities since 1963. They are bred by the thousands in underground facilities, the Dulce facility is the most well-known place that this activity occurs, although there are at least another twenty-six (26) bases within the United States that have similar facilities.

The Delta Group, within the Intelligence Support Activity, have been seen with badges which have a black triangle on a red background. A Delta is the fourth letter of the Greek alphabet, it has the form of a triangle, and figures prominently in certain Masonic Signs.



Each Base Has its Own Symbol

The Dulce Base symbol is a triangle with the Greek letter TAU", (T) within it and then the symbol is inverted, so the triangle points down.



The Insignia of "a triangle and three (3) lateral lines" has been seen on Alien Transport Craft, The Trilateral Symbol.



Other symbols mark landing sites and Alien Craft



[Inside the Dulce Base](#)

Security officers wear jumpsuits, with the Dulce Symbol on the front upper left side. The standard hand weapon at Dulce, is a "Flash Gun", which is good against human and Aliens. They use a Retina-Reader for Identification in substitution of the old ID Cards, but the ID card readers are still used in card slots, for the doors and elevators, which had the Dulce Symbol above the ID Photo.

After the second level, everyone is weighed in the nude, then given a uniform, visitors are given one off-white uniform. In front of all sensitive areas are the Retina-Readers and scales built under the doorway, by the door control. The clearance is checked, identity is checked and also the weight. Any possible change over two pounds and a security yellow is alerted.

No one, without a specific clearance or authorization, is allowed to carry anything into or out of sensitive areas. All supplies are put through a security conveyor system. The Alien symbol language, Grey and Nordic appear a lot at the facility.

During the construction of the facility, which was done in stages, over many years, the Aliens assisted in the design and construction materials. Many of the things assembled by the workers were of a technology they could not understand, yet, now a days it is a different story, it would function when fully put together.

Example: The elevators have no cables; they are controlled magnetically. The magnet system is inside the walls. There are no conventional electrical controls. All is controlled by advanced magnetics. That includes a magnetically induced, (phosphorescent), illumination system. No regular light bulbs, and all exits are magnetically controlled.

Note: If you were to place a large electromagnet on an entrance, it will affect an immediate interruption. They will have to come and reset the system, and "blow away your head, if they catch you!"

[The Town of Dulce](#)

The area around Dulce has had a high number of reported animal mutilations. The Government and the Aliens used the animals for environmental tests, psychological warfare on people, etc.

The Aliens also wanted large amounts of organic material for Genetic Research, Nutritional and other reasons.

In the book, "ETs and UFOs, they need us, we don't need them", was an original idea for one title, but not my personal choice, by Virgil "Posty" Armstrong, he reports how his friends Bob and Sharon stopped for the night in Dulce and went out to dinner, they overheard some local residents openly and voice fully discussing Extraterrestrial abductions of the townspeople for purposes of experimentation.

The ETs were taking unwilling human guinea pigs from the general populace of Dulce and implanting devices in their heads and bodies. The townspeople were frightened and angry but didn't feel they had any recourse since the ETs had our Government's knowledge and approval, (CODE: SR-24/AK.5).

Recently, participants in a field investigation, (CODE: SR-24/R25/AK.2), of the area near Archuletta Mesa, were confronted by two small hovering spheres.

They all became suddenly ill and had to leave the area Several Dulce residents are not naturally from this area, single people and even couples with children, have just come to the town of Dulce since 1948.

Generations of frozen agents occupied in suspect positions like at work in a gas station, drugstore, bar, restaurant, etc. They're there to listen and report anything which violates their limit of security.

Always in the town of Dulce, you never know who is who.

[Mind Manipulation Experiments](#)

The Dulce Base has studied mind control implants; Bio-PSI units; ELF Devices capable of mood, Sleep and Heartbeat control; etc.

Defense Advanced Research Projects Agency, (DARPA) is using these technologies to manipulate people. They establish "The Projects", set priorities, coordinate efforts and guide the many participants in these undertakings.

Related Projects are studied at Sandia Base by the "Jason Group" of fifty-five scientists from thirty-eight specific scientific areas. They have secretly harnessed the Dark Side of technology and hidden the beneficial technology from the public.

Other projects take place at "Area 51" at Groom Lake in Nevada, codename "Dreamland", which is a data and ongoing projects repository and establishment for just some of the following:

- Electromagnetic Intelligence, (ELMINT)
- Code: Empire
- Code: EVA
- Prometheus Project
- Hybrid Intelligence System Program, (HIS)

- BW/CW
- Infrared Intruder Systems Project, (IRIS)
- BI-PASS
- REP-TILES

The studies on Level #4, at Dulce, include human/Alien, Aura Research, as well as, all aspects of Dream, Hypnosis, Telepathy, etc. They know how to manipulate the Bioplasmic body of humans. They can lower your heartbeat with deep sleep "Delta Waves", induce a static shock, and then re-program via a brain-computer link. They can introduce data and programmed reactions into your mind, (information impregnation, "The Dream Library").

We are entering an ERA of the technologicalization of psychic powers, this means, the development of techniques to enhance man and machine communications:

- Nano-Technology
- Bio-Technology
- Micro-Machines
- PSI-War
- Electronic Dissolution of Memory, (EDOM)
- Radio-Hypnotic Intra-Cerebral Control, (RHIC)

...as well as, various forms of behavior control via:

- Chemical Agents
- Ultra-Sonics
- Optical Frequencies
- Electro-Magnetic, (EM) Frequencies

...which are directed to the physics of 'Consciousness'.

Better Living through Bio-Tech?

The development of "Bio-Technologies" will mean a revolutionary change in life of every human being now on Earth! WARNING! "FASCISM IS CORPORATISM". We have passed the point of no return, in our interaction with the Alien beings. We are guaranteed "A CRISIS" which will persist until the final revelation or conflict.

The crisis is Here, Global and Real. We must mitigate or transform the nature of the disasters to come, and "come they will". Knowing is half the battle.

ADVICE: Read the Book, "The Cosmic Conspiracy" by Stan Deyo.

The Phantom Empire - "Above the Law"

The Dulce Base is run by a Board:

- The Chairman of the Board is John Herrington.
- Jim Baker of Tennessee is the NSA/CIA link to Dulce.
- House speaker Jim Wright of Dallas Texas, the Nation's third highest office, is the Treasurer at Dulce.

There is currently a power struggle going on, as Rep. William Thomas, R-California, put it, "Part of Jim Wright's problem is he fails to understand what's equitable and fair. It's the arrogance of power".

Even among his fellow Democrats, many find Wright to be uncomfortable, Wright's operating style leaves him vulnerable.

Most meetings of the Dulce Board are held in Denver, Colorado and Taos, New Mexico. Former New Mexico Senator Harrison, publicly known only as "Last Man on the Moon" Schmitt has full knowledge of Dulce. He was one of seven astronauts to tour the base.

In 1979, he held a "Animal Mutilation" conference in Albuquerque, New Mexico. This was used to locate researchers and determine what they had learned about the links between the "Mute" operations and the Alien/Government deals.

Senator Brian of Nevada, knows about the "Ultra Secrets at Dreamland" and Dulce. So do many others in the Government, "this is what the UFO researchers are up against", **SO BE CAREFUL!** They have killed to keep this information secret, and by reading this document, you now know more than they want you to know!

They also have underwater bases off the coast of Florida and Peru. More detailed information will be released by the Government following the plan of preparation for a Global Alien revelation, in the very near future. Photos, Video Tapes, Documents, etc. will be released. Watch for Agents among you now.

After all, a fascist group, within this country, had John Kennedy assassinated and got away with it. Look to the links, within the larger umbrella, the "Web" of a fascist totalitarian Secret Police State, within the Pentagon; JCS; DIA; Division Five of the FBI; DISC/DIS and CIA.

NOTE: The Defensive Investigative Services (DIS) - Their insignia is a composite of the Sun's Rays, a Rose, and a Dagger, Symbolizing "The search for information, trustworthiness and danger".

The following are basic diagrams of process of creation of artificial hybrids at level #7, at the Dulce Complex:

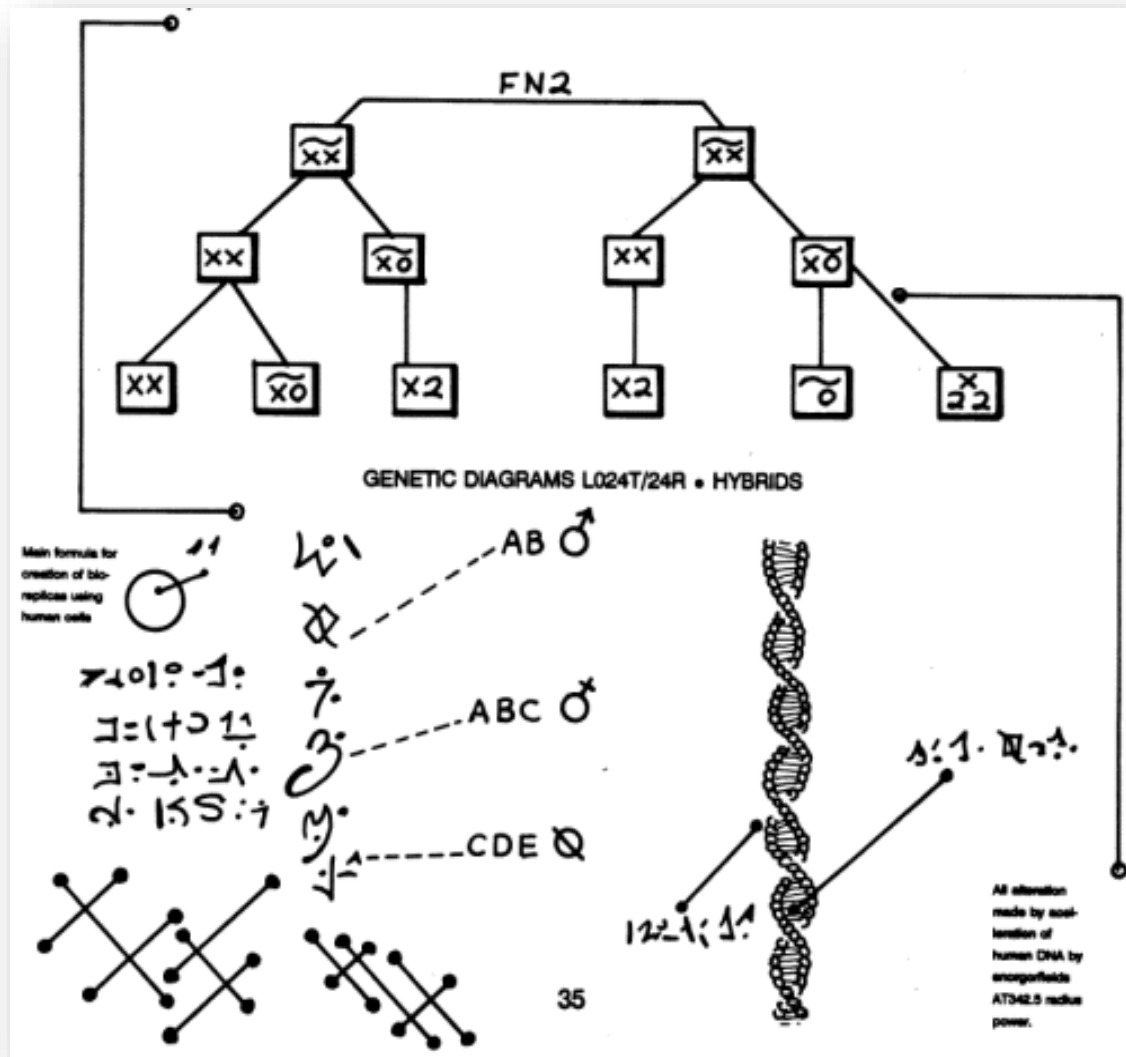

KINDS OF ALIEN LIFE FORMS WE KNOW ABOUT

An Anthropological Analysis:

- U.S. Government Data from Autopsies of Aliens
- Uni-Terrestrial Data, Code: UNA
 - Mission Skills and Assignments Chart
 - Mission
- Ultra-Terrestrial Data, Code: ULTRON
- Intra-Terrestrial Data, Code: INTERAV
- Meta-Terrestrial Data, Code: MEREDITH
- Para-Terrestrial Data, Code: PARAMUS
- Greys

- Extra-Terrestrial Data, Code: EBEs
 - The First EBE
 - KRL
- Rigelians
 - The Rigelian Saga
 - Alien Bases at Sol III Perimeter
 - Project BETA, The Study of Grey Psychology
 - Taxonomy of some Extra-Terrestrial Humanoids
- Greys Data from Autopsies
 - Type A
 - Type B
 - Type C
- Nordics Data from Autopsies
 - Type D
- Oranges Data from Autopsies
 - Type E

THE U.S. GOVERNMENT HAS CONDUCTED AUTOPSIES ON ALIEN CADAVERS (Grey Physiology and Anatomy)

The most significant Alien specimens, which have been available to autopsy have been the "Grey Types".

The approximate height of most specimens are between 3.5 and 4.5 feet. The head, by human standards, is larger in comparison with the body. Facial features show a pair of eyes described as large, sunken or deeply set, far apart or distended more than a human's, and slightly slanted as oriental or mongoloid. No ear lobes or apertures on the side of the head were visible. The nose is vague, one or two small holes have been identified as nostrils. The mouth area is described as a small slit or fissure. In some cases, there is no mouth at all. It appears not to function as a means for communication or for alimentation. The neck area is described as being thin, and in some cases, not being visible at all because of the tightly knit garment. Most observers describe these humanoids as being hairless. Some of the bodies recovered have a slight hair patch on top of the head. Others appear with what appears to be like a silver skullcap.

There were no breathing attachments or communication devices. This suggests telepathy with higher intelligence. In one case, there was an opening in the right frontal lobe area, revealing a crystalline network. This network implies the development of some sort of third brain.

We also found a spherical object which was more or less 1 cm in size and was linked with the crystalline network. We theorize that this is a device for amplification of their brain waves, which means they are not capable of psychic activity without the spherical device. This information is also included in the "YELLOW BOOK".

The arms are described as long and thin, reaching down to the knees. The palms each contained four fingers, with no thumbs. Three fingers are longer than the others. Some are very long, and

others are very short. No description is available for the legs and feet. Some pathologists indicate that the section of the body was not developed as we would anticipate, showing that some of these beings were adapted to life in the water.

According to most observers, the skin is grey. Some claim it is beige, tan, or pinkish grey. No reproductive organs or capabilities were discovered, no phallus or womb. This suggests cloning is the current reproductive method, which has been mentioned in other sources. The humanoids appear to be a mold, sharing identical racial and biological characteristics. There is no blood as we know it, but there is a fluid which is grayish in color.

UNI-TERRESTRIAL - CODE: UNA

(Seven ancestral Alien races that started our civilization here)

Some of the unanswered questions about the human evolution, started centuries ago, when disaster struck a mission involving seven different Alien races to Earth.

This information was recovered from PROJECT GENESIS III (G-III) - ADN6.2 - CR-7/26TSW-3 and CLR-25/M6-722 - CLAS.ATR26/AC #672/B25, as well as other crash sites.

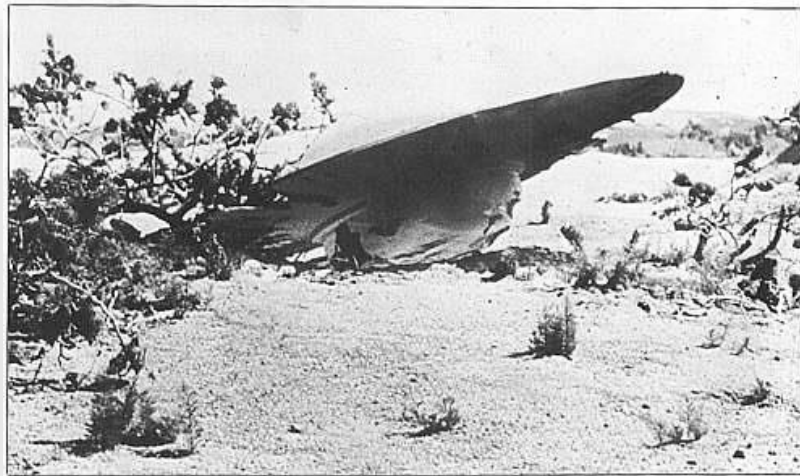

ANTHROPOLOGICAL DESCRIPTION OF EACH RACE OF ALIENS

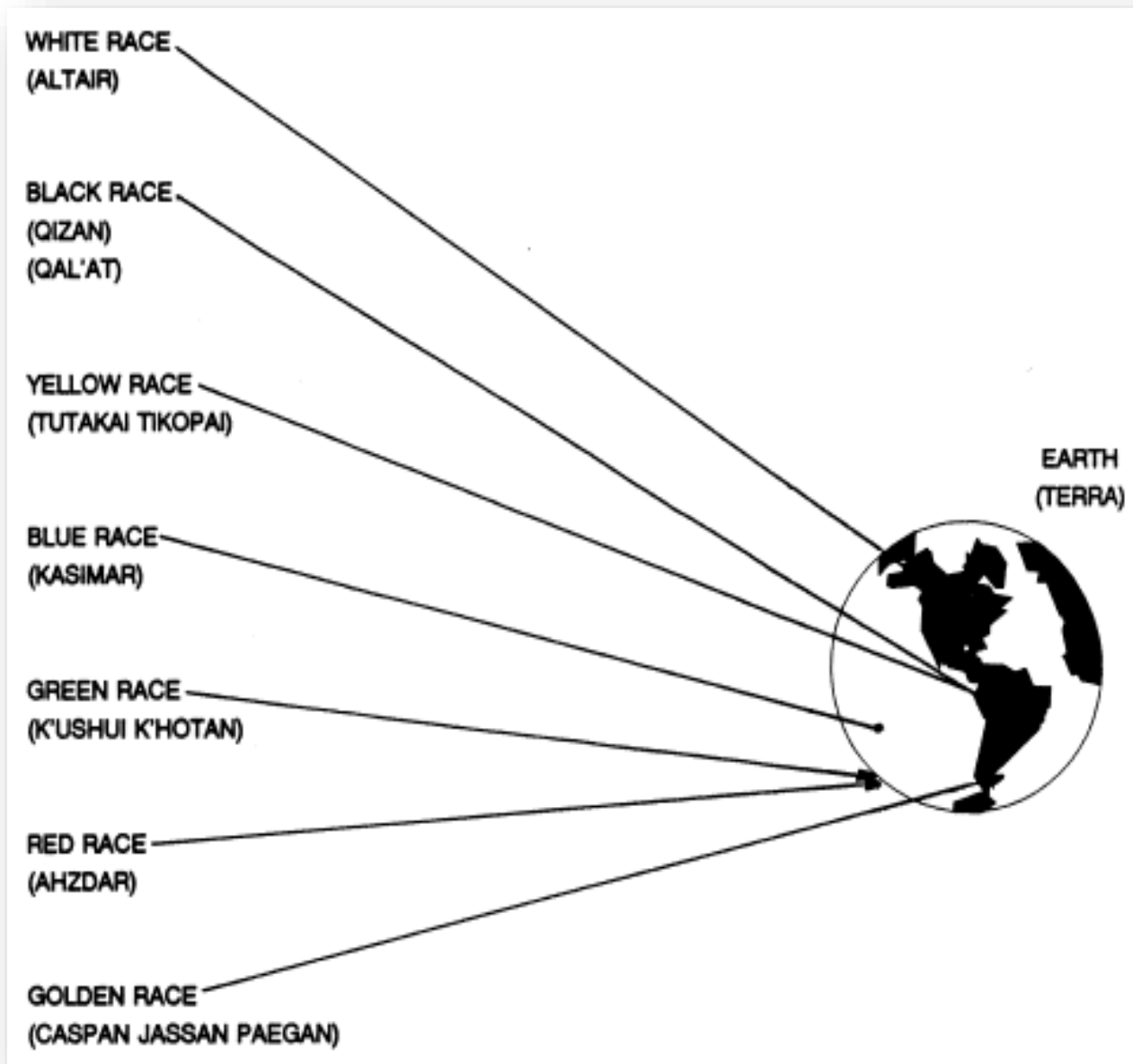

- WHITE RACE Altair** - Relative range of absolute visual magnitude (+2).
 - Carbon Hominoid lifeform.
- Kingdom: Animal
 - Phylum: Vertebrata (Obs)
 - Class: Mammalia (Hominid Biped)
 - Order: Primata
 - Family: Hominidae
 - (no sub-family)
 - Genus/Species: Homo Altair
- BLACK RACE Qizan Qal'At** - Binarie
 - Relative range of absolute visual magnitude (+7E)
 - Carbon Humanoid lifeform.
- Kingdom: Animal
 - Phylum: Vertebrata
 - Class: Mammalia
 - Order: Primata
 - Family: Hominidae
 - Sub-Family: Qal'Atzoid
 - Genus/Species: Homo Qizan Qal'At
- YELLOW RACE Tutakai** - Binarie
Tikopai - Relative range of absolute visual magnitude (+7E)
 - Carbon Humanoid lifeform.
- Kingdom: Animal
 - Phylum: Vertebrata (Obs)
 - Class: Mammalia (Humanoid Biped)
 - Order: Primata
 - Family: Hominidae
 - Sub-Family: Tikopaizoid
 - Genus/Species: Homo Tutakai Tikopai
- BLUE RACE Kasimar** - Relative range of absolute visual magnitude (+5)
 - Carbon Humanlife lifeform.
- Kingdom: Animal
 - Phylum: Vertebrata (Obs)
 - Class: Mammalia (Humanoid Biped)
 - Order: Primata (Anphibio)
 - Family: Hominidae

- Sub-Family: Mermannus Kasimarzoid
- Genus/Species: Homo Kasimar

- GREEN RACE**
- K'ushul** - Binarie
 - K'hotan** - Relative range of absolute visual magnitude (+7E)
- Carbon Humanoid lifeform.
 - Kingdom: Animal
 - Phylum: Vertebrata (Obs)
 - Class: Mammalia (Humanoid Biped)
 - Order: Primata
 - Family: Hominidae
 - Sub-Family: K'hotanzoid
 - Genus/Species: Homo K'ushui K'hotan

- RED RACE**
- Ahzdar** - Relative range of absolute visual magnitude (+5)
- Carbon Humanoid lifeform.
 - Kingdom: Animal
 - Phylum: Vertebrata (Obs)
 - Class: Mammalia (Humanoid Biped)
 - Order: Primata
 - Family: Hominidae
 - Sub-Family: Hominahzdarzoid
 - Genus/Species: Homo Ahzdar

- GOLDEN RACE**
- Capsan** - Trinarie
 - Jassan** - Relative range of absolute visual magnitude (+7E)
 - Paegan** - Carbon Humanlife lifeform.
 - Kingdom: Animal
 - Phylum: Vertebrata (Obs)
 - Class: Mammalia (Humanoid Biped)
 - Order: Primata
 - Family: Hominidae
 - (no sub-family)
 - Genus/Species: Homo Caspan Jassan Paegan

MISSION SKILLS & ASSIGNMENTS

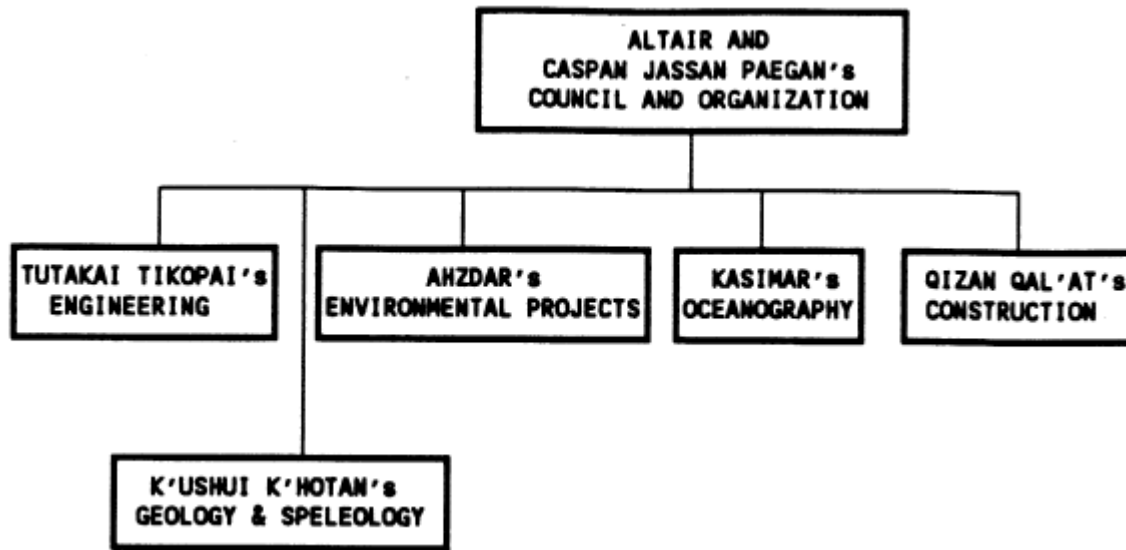

- **MISSION:** Genetic Research and Colonization of the 3rd Planet (Terra) of the Star (Sol) "our sun" of the Milkyway Galaxy (N'erandha B'hai).
- **STATUS:** OUT TO CONTROL
- **GROUP:**
 1. Altaires
 2. Qizan Qal'Ats
 3. Tutakai Tikopais
 4. Kasimars
 5. K'ushui K'hotans
 6. Ahzdars
 7. Caspan Jassan Paegans
- **SEQUENCES OF MISSION:**
 1. Division of the area looks more like their original planets. Division of Terra, Mars, and Phaeton.
 2. Research with Earth Reptilians - caused a mutation now called the dinosaurs.
 3. Research with Mammalia mutations.
 4. Erased (Killed Off) Dinosaurs.
 5. Crisis at Star Sol, (our Sun).
 6. Destruction of the original mission.
 7. Survivors and their mental problems, left from destruction of mission.
 8. War between survivors.
 9. Destruction of Phaeton, creation of asteroid belt, (Van Allen asteroid belt).
 10. Survivors.
 11. Survivors separated and created the Ancient civilizations known as Lemuria, Mu,

and Atlantis.

12. Homo Sapiens, Homo Mermanus, and Homo Interior co-exist on Earth with survivors.
13. New Aliens Landings by the Dominion Grey and Nordic races.

MISSION STAR MAP Code: UNA
(Recovered from Crashed Alien Spaceship)

ULTRA-TERRESTRIAL - CODE: ULTRON

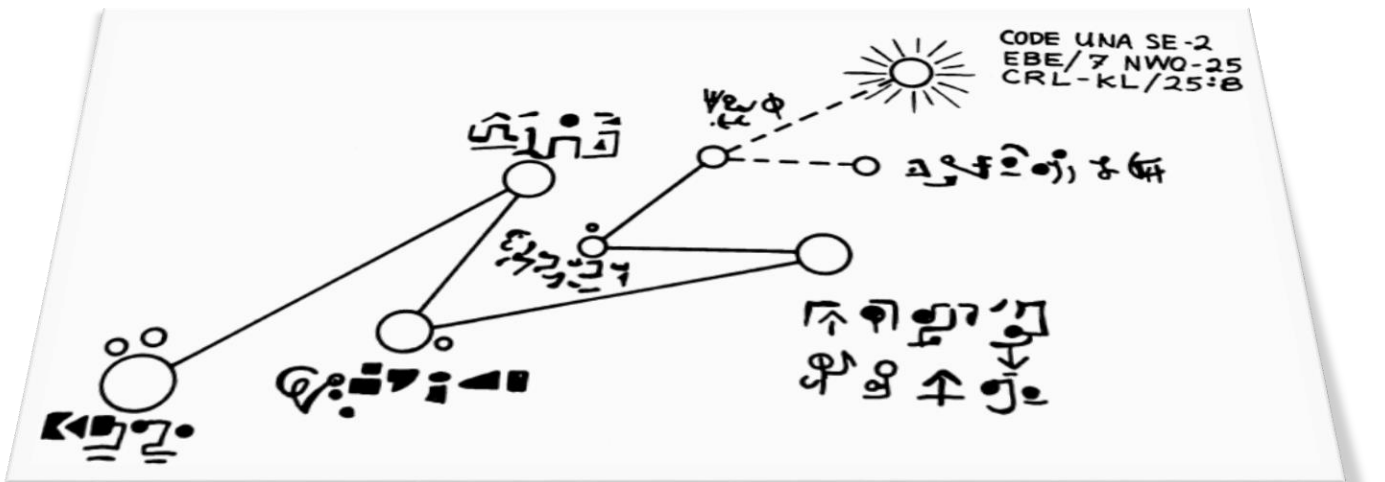

(Energetic/Intelligent life forms without material body)

This information was recovered from NCR/27B-01 MWC-2.B7 - AC "GODAR" PROJECT, as well as other crash sites.

This Alien is created in the centers of quasars. A type of sensitive energy living in the center of pure energy, and is a component more stable than the material Solioa that is found in our quasar.

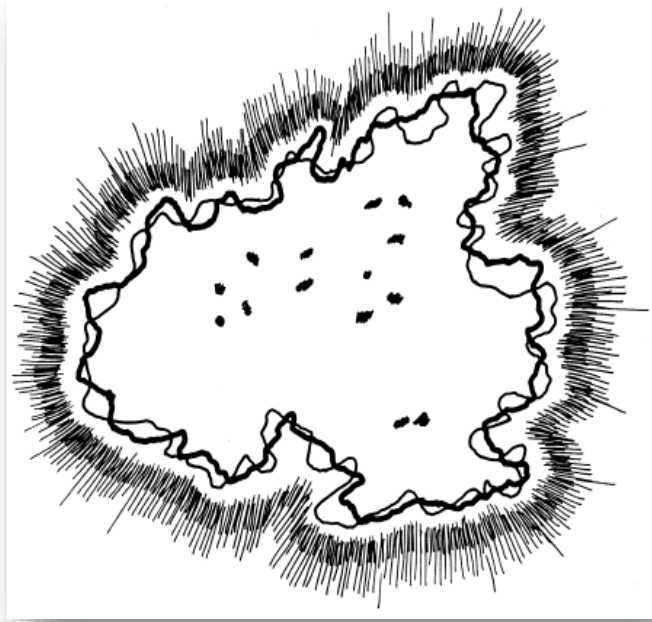

They evolved from a series of mono-electronics, to a series of more complex energy and created a collective civilization that does not know the individual thought or mind.

The Ultrons are an entity composed of primary mental energy, and radiates strong in the visible, ultraviolet and Kappa Radiation bands. As are "Nodes or Foir" serve as the origin of the Ultrons' radiant emissions.

As the spectrograph proceeds through the Ultraviolet range from 103.2 to 112 angstrom units, we observe that these Foir are not constant for different wavelengths; by varying their relative positions, the Ultrons can control the intensity of their emissions.

Ultrons perceive dimension and objects in terms of electromagnetic energy - knowing the speed of light through various mediums, it is able to judge its surroundings much as the Terran Bat is able to use the reflection of its own sounds to avoid flying into an object.

The radioactive nature of the Ultrons a non-corporeal being, best suited by the Hutchinson Radiation Analysis (HRA) - a graphic representation of any energy source, in this case the life aura of the Ultrons are strongest in the ultraviolet range, the HRA is a standard readout on most sensor-equipped instruments appearing as a fluctuating 'moiré pattern.'

INTRA-TERRESTRIAL - CODE: INTERAV

(People from outside Earth/Dimension/Time-Space of life at Planet Earth from ancestral time)

This information was recovered from INAC/26.7B - AC 43.2, INAC-02, as well as other crash sites. They came to Earth several EON's ago and now Terra (or Earth) is their planet too.

We talk here about the seventh largest race, we found two large races living below the four earth capades...

THE REPTILOIDS

Kingdom: Animal
Phylum: Vertebrata
Class: Reptilia
Order: Theropoua
Family: Hominidae
Genus/Specie: Homo Lacerate

LEVEL OF SPECIE: BETHA RDN-3

OBS: Survive only close to specific devices

They live at a former society and have a high degree of technology.

THE REPTILOIDS DATA

- Average Height:
 - Male: 2.0 Meters
 - Female: 1.4 Meters
- Average Weight:
 - Male: 200 Kilos
 - Female: 100 Kilos
- Body Temperature:
 - Male: Ambient Temperature
 - Female: Ambient Temperature
- Pulse/Respiration:
 - Male: 40/10
 - Female: 40/10
- Blood Pressure:
 - Male: 80/50
 - Female: 80/50
- Life Expectancy:
 - Male: 60 Earth Years
 - Female: 23 Earth Years



REPTILOID
Type A
Male



REPTILOID
Type B
Male

Cold-blooded, like all reptiles, the Reptiloid is found to flourish in a warm, tropical climate (normally artificial at the big caves). With imperfect respiration providing just enough oxygen to supply tissues and maintain the processing of food and combustion, their temperature can be raised only a few degrees above the ambient. The reproductive system is ovouniparous, with eggs hatching in the oviduct prior to birth.

The underdeveloped Reptiloid (for faster activities, physical activities) cerebellus results in a slowness and simpler city of movement. The Reptiloid eye is composed of thousands of microscopic facets, each facet with its own independent protective lid. The eye is almost never closed entirely during waking hours; rather, section of the organ is shut down in conjunction with the dominant light source.

NOTE: The Reptiloids or Reptoids survived "Hidden" inside the Earth at a Big Cave Underground surface.



REPTILOID OR REPTOID
Type C
MALE

News Clippings

Los Angeles Times
Thursday, July 21, 1988

..... Newsmakers..... It's a Hulk

- Christopher Davis 17, swears the creature that attacked him while he was changing a tire in the middle of the night in Scape Ore Swamp near Browntown, S.C., was 7 feet tall and had red eyes and three fingers on each hand. Then Tom and Mary Waye reported that their car had been 'chewed up' at the same location. Was it the Lizard Man, as the locals are calling him, or just a red fox or a 'muddy drunk' - the theory of state biologist Matt Knox, who has been called in to help investigate the sightings?

Sheriff Liston Truesdale said he has been swamped with phone calls from people claiming to have seen the slimy critter, 'and these are reputable people'. The run with television crews and observers 'hoping to catch a glimpse of Lizard Man, and a Columbia News station is offering a \$1-million reward for his capture.

Los Angeles Herald Examiner

Thursday, July 21, 1988

..... It's Lizard Man /. Story of 7-foot 'Lizard Man' puts the creeps into town BROWNTOWN, S.C.

- The sheriff has been hearing a lot about the 'Lizard Man', 7 feet tall with red eyes and three fingers on each hand, but a state biologist says everybody would be better off looking for a red fox or a muddy drunk.

Christopher Davis, 17, told Sheriff Liston Truesdale he had been attacked several weeks ago by the creature in Scape Ore Swamp as the teen-ager was changing a flat tire about 2 a.m.

Truesdale said he is getting other calls from people who said they saw the creature, 'and they are reputable people' - Gary C. Fong, from news service reports.

SERV 58.6 ABR - CB-7 PANT. BOLHN 2E - AC (MULDOSV)

THE INSECTOIDS

- Kingdom: Animal
- Phylum: Vertebrata
- Class: Mammalia
- Order: Primata
- Family: Insectoid
- Genus/Specie: Homo Insectoid
- LEVEL OF SPECIE: Unknown
- OBS: Unknown

THE INSECTOID DATA

- Average Height: (Master Race)
 - Male: 1.6 Meters
 - Female: 1.2 Meters
- Average Height: (Servant Race)
 - Male: 1.0 Meters
 - Female: 1.0 Meters
- Average Weight: (Master Race)
 - Male: 70 Kilos
 - Female: 40 Kilos
- Average Weight: (Servant Race)
 - Male: 35 Kilos
 - Female: 35 Kilos
- Body Temperature:

- Male: 102 degrees Fahrenheit
- Female: 102 degrees Fahrenheit
- Pulse/Respiration:
 - Male: 110/2
 - Female: 110/2
- Life Expectancy:
 - Male: 130 Earth Years
 - Female: 150 Earth Years

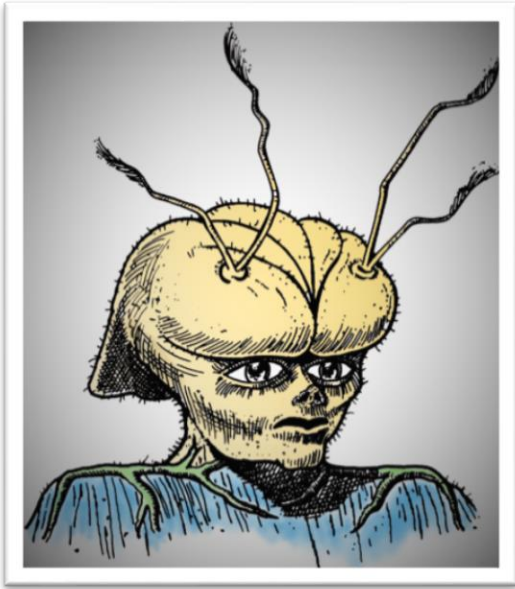

INSECTOID (Masters) Type 1



INSECTOID (Servants) Type 2

The Insectoid retina is composed entirely of tone-sensitive rods, and is incapable of discrimination between different wavelengths of light. Therefore, the addition of color to the insectoids' vision is accomplished by the dual antennae which, in addition to being auditory receptors, are made up of a complex network of wavelength-sensitive cones.

Owing to the highly directional nature of the antenna, the corona of vision is perceived by the subject in tones of grey. Because of this correlation of four independent light-receptive organs, Insectoid vision can be correctly termed "Quadrosopic", resulting in relatively (Humanoid) superior depth perception. Insectoid auditory capacities are highly developed, and Insectoids are capable of distinguishing from among a wider range of audio frequencies than is normal for humanoids.

Because of the mono-directional antennae, Insectoids usually listen with their head tilted slightly downward. NOTE: They have a limited exoskeleton.

[SERV 59.60, 61, 62, 63 ABR - CB-7 PANT. BOLHN 28 - AC \(MULDOSV/PLUS\)](#)

Several races, including some already discussed, make their home in the Inner-Earth. These are as follows:

- Green People - Part of the survivors, survived as part of the ancient K'ushui K'hotans or green people.
- Caspan Jassan Paegans or Golden Race - Part of the survivors, survived inside big group of mountains at Orient part of Earth. They created the Essenis.
- The Eternals - Some surviving people from Altair genetic mutated, which caused getting older to be incredibly slowed down, enabling them to live for EON's.
- The Kasimar or Blue Race - Some surviving people created the people of MU, LEMURIA and ATLANTIS. The survivors now live in inner-Earth and some Atlanteans live underwater.
- The Deviants - Are surviving people that mutated from Kasimar/Insectoids (very dangerous and primitive creatures). The legend of DEMONS was born from the underground Deviant race. See below for sketch of the Deviant:



The Deviant

(Aliens from another Time/Space or Earth people from another Time/Space)

META-TERRESTRIAL visitors are from another time and space. This information was recovered from CRM/26.06 - ABR-26, as well as other crash sites. Time Travelers - Our files take only the Essassani Race. A cross-breeding between Humans from Earth and Extra Terrestrial from Zeta-Reticuli from one of our possible futures.



Of course it is possible there could be other races of Meta-Terrestrial, we just don't have enough data yet about it.

NOTE: You found a example of Essassani Race watching the Steven Spielberg's movie "Close Encounters of the Third Kind" (Look for the special version, it's better).

[PARA-TERRESTRIAL - CODE: PARAMUS](#)

(Aliens from multi-universe)

The Para-Terrestrial come from several different parallel universes from the Multiuniverse. When they accelerate or decelerate the frequency of vibration of their atomic structure they are able to exist at our 3rd dimension. This information was recovered from IACT/26, OBR-32 - AC 204 (BANTY), as well as other crash sites.

We can't tell much about these beings, because we don't have enough Data about it yet.

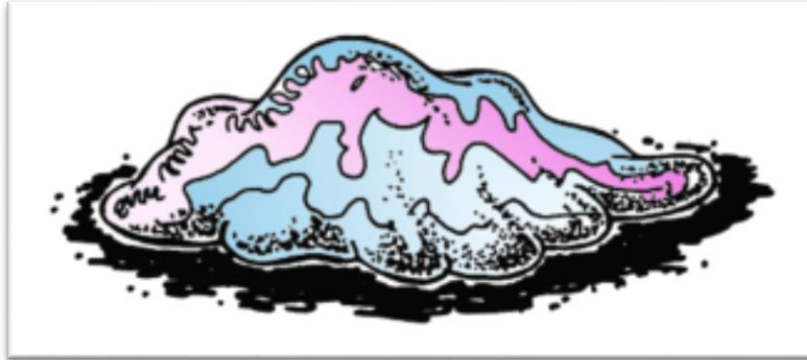

The XZ Creature

1. The name of this creature is almost impossible to repeat or even to write. We call this intelligent creature XZ. They look like one single Ameba or Jelly.



⌘

2. The MOOK - A very small (1.3 Meter) and hungry creature with long arms and three fingers, wearing funny clothes



3. The WADIG - Looks like a primitive kind of primate but he is an intelligent being. Normally he never wears clothes (this fact, makes strong the idea some people believe that the WADIG is some kind of primitive missing link)

We can continue talking about Para-Terrestrial but is not logical because we don't have necessary quantity of Data for making good research. This is because we talked only about the X2, The MOOK and the WADIG just for literal illustration of matter.

GREYS

EXTRA-TERRESTRIAL - CODE: EBEs

(Aliens from 3rd dimension, or from outside earth)

This information was recovered from IAC - XXXX - P14AB and IAC - XXXX - P14NR, as well as other crash sites.

Extra-Terrestrial

Wrongly designated ALFs, (Alien Life Forms). I said that because all other five types are ALFs also. All six types of aliens are ALFs. We have around 160 different species at our biosphere from several points in the universe. They are Humanoids, Human and Not Humans.

We talk now about the other five Alien races that stayed much longer than any other race and have much more influence during our history.

1. Type A: Rigelian, Rkjel, or Gray
2. Type B: 2-Reticulae, Z-Reticuli 1, or Grey
3. Type C: 2-Reticulae, Z-Reticuli 2, or Grey
4. Type D: Orion, Pleiades, or Nordic
5. Type E: Barnard Star, Orange

THE FIRST EBE - IAC - XXXX - P14SC

EBE is the name or designation given to the live extraterrestrial Alien captured at the 1947 Roswell, New Mexico crash. He died in captivity.

NOTE: O.H. Cril was a "Joke" created by John Lear and other friend for personal purposes. Nobody knows why Lear denies the KROLL existence.

KRLL

KRLL or KRLLL or CRLL or CRLLL pronounced Crill or Krill was the hostage left with us at the first Holloman landing as pledge that the Aliens would carry out their part of the basic agreement reached during that meeting. KRLL gave us the foundation of the YELLOW BOOK which was completed by the Alien guests at a later day.

KRLL became sick and was nursed by Dr. G. Mendoza who became the expert on Alien biology (Exobiology). His information was disseminated under the pseudonym O.H. Cril or Crill. KRLL became the Regelian Ambassador to the United States.

There have been rumors of KRLLs death. We don't know if they are true or not.

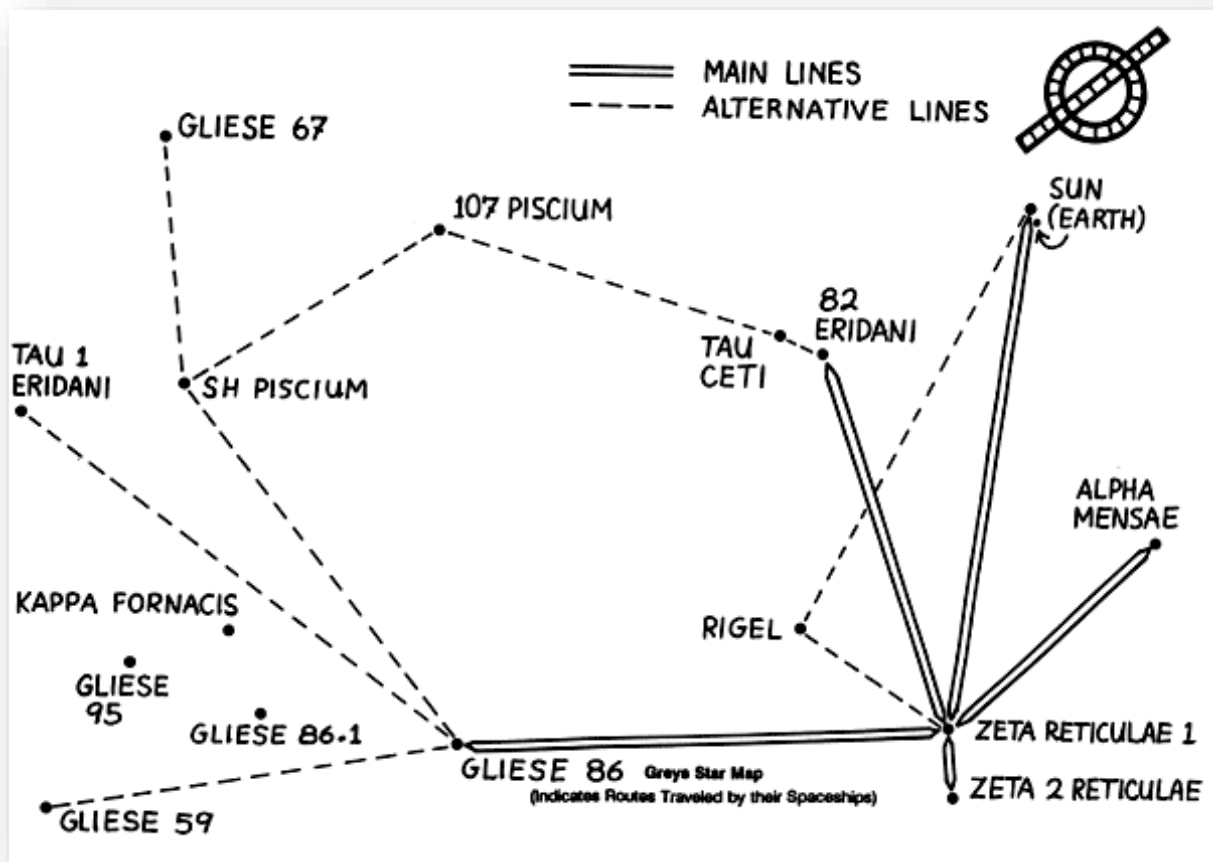

Note: Map taken from Crystal Storage device inside a Crashed Alien Ship



RIGELIANS - Also called Malevolent Alien Life Form (ALF)

RIGELIAN

The Typical Malevolent ALF as represented thus far can be described as follows:

- Between three (3) to five (5) feet in height.
- Erect standing biped. Long thin legs.
- Small build (thin).
- Head larger than normal, (to human proportions).
- Absence of auditory lobes, (external ear lobes).
- Absence of body hair.
- Large, tear shaped eyes, opaque black with vertical slit pupils, (cats eyes).
- Eyes slanted approximately 35 degrees.
- Small straight mouth, with thin lips.
- Arms resemble praying mantis, (normal attitude), arms reach to knee when extended.
- Long hands, with small palms.
- Claw like fingers, (two short, two long webbed fingers).
- Tough, grey skin, reptile like in texture.
- Small feet with four (4) small claw like toes.
- Some organs are similar to humans but developed in a different evolutionary process.
- The most significant finding is that they have a nonfunctioning digestive system and two separate brains. The digestive system in those examined were atrophied, conforming to absence of provisions in recovered crash. This however, is still just preliminary findings.
- Movement is deliberate, slow and precise.
- Secondary findings, after crash site study
 - Alien subsistence requires that they must have human blood and other human biological substances to survive.
 - In extreme cases (circumstances) they can subsist on other animal fluids.
 - Food is converted to energy by Chlorophyll through photosynthesis and waste products are excreted through the skin, (some kind of botanical life form?).
 - These creatures possess two separate brains separated by the mid cranial lateral bone partition, (anterior brain, posterior brain) with no apparent connection

between the two.

- ALFs furnished extensive information on the Aliens and their history which is known as the "YELLOW BOOK".
- Because the Aliens have a tendency to LIE, we can't be 100% sure about all the information inside the "YELLOW BOOK".
- LUNA-1 is the Rigelian base at the other side of the Moon, or the far side of the Moon like some scientists prefer to say. It was seen and filmed by the Apollo Astronauts. A base, a mining operation using very large machines, and the very large Alien Crafts described in sighting reports as "Mother Ships" exist there.
- WAVENEST is the Regelian base in the Atlantic Ocean. A underwater Alien base, mining and big Cigar shaped crafts.



REGELIAN

Type A

The Rigelian Saga

The original contact between the government and the *Extra-Terrestrial Biological Entities (EBEs)*, who normally are Grey in color and about three and a half to four and a half feet high and coming from the Rigel Star System (hereafter referred to as the Greys) was achieved between 1947 and

1971. We knew that the Greys were instrumental in performing the mutilation of animals, as well as some humans and that they were using the glandular substances derived from these materials for food (absorbed through their skin) and to clone more Greys in their underground laboratories.

The government insisted that the Greys provide them with a list that would be presented to the National Security Council (this list has never been completed). Through all this, the government thought that the Greys were basically tolerable creatures, although a bit distasteful. They presumed at the time that it was not unreasonable to assume that the public would and could get used to their presence. Between 1968 and 1969 a plan was formulated to make the public aware of their existence over the succeeding twenty (20) years. This time period would culminate with a series of documentaries that would explain the history and intentions of the Greys.

The Greys assured the government that the real purpose of the abductions was for monitoring of our civilization, and when they learned that the abductions were a lot more frequent and insidious than they were led to believe, the government became concerned. Their concern was also based on additional information regarding the purposes for abductions. By the time the government had found out the truth about the intentions of the Greys, they, the Greys, intended to stay here, where they always will stay in control of Earth, "it was too late". The government by mistake had already "Sold Out" humanity. Not that it would have made any difference, because they were here doing what they were doing anyway.

In 1983, a story was outlined by the government sources that said that the Greys are responsible for our biological evolution through manipulation of the DNA of already evolving primates on this planet, they don't like to tell anybody that the real Rigelians are Nordics and they found survivors from one big catastrophe, the ancestral seven races, the Uni-Terrestrials.

Various time intervals of the DNA manipulation were specified for 25 000, 15,000, 5,000 and 2,500 years ago originally, the government thought that the Greys meant us no harm, but in 1982 to 1988 the picture that emerged was exactly the opposite. The story now is one great deception at several different levels. The Greys "Trojan Horse" style manipulation and lying, which involved MJ-12/Majic forces, from over four decades ago, now it's 1990, the government still uses disinformation on the subject of UFOs, in order to perpetuate the agreement with the Greys, free of public scrutiny; the lies to the abductees, the Greys ongoing abduction of people and mutilation of animals in order to harvest enzymes, blood, and other tissue for their own survival needs, and a genetic blend of the Grey race and a tall Nordic act to enable Grey interface with humans to be done with greater ease.

The apparent reasoning for the Grey preoccupation with this is due to their lack of a formal digestive tract and the fact that they absorb nutrients and excrete waste directly through the skin. The substances that they acquire are mixed with hydrogen peroxide and painted on their skin, allowing absorption of the required nutrients. It is construed from this that some weaponry against them might be geared in this direction.

The inner-core of the CIA is deeply controlled by the Greys. The CIA view's interaction with the Greys as a path to greater scientific achievement. One reason for so many UFOs is that other cultures are watching with extreme interest Scientists from other cultures arrive to watch. The

Greys also are working with some groups of UFO fanatics, lying to them, and using them. The ultimate evil is masked and is of psychological complacency that leads one to adhere to a group philosophy rather than eke out one's own horizons.

As soon as you acquire an awareness of being a so called "chosen special group" you are on the road to a fall. That is the seed of destruction in any society and any culture and it leaves it vulnerable. It will be the eventual undoing of the Greys as well. They see not their error, it is the very weakness they seize upon that is their own inherent weakness. To try and change a Grey, or a mistaken cult type of "Star Person" (following the Grey plan) is futile.

It will happen but all in its own good time, it is the spirit that makes anyone stand up and disagree with something that is untrue and incorrect that will be the thorn in the side of the Greys, and other forces that have allied with them.

Alien Bases at SOL III Perimeter

During the occupation of the Greys, they have established quite a number of underground bases all over the world, especially in the United States. One such base, among other in the same state, is under Archuleta Mesa, which is about two and a half miles Northwest of Dulce, New Mexico. Details about that base come across by way of several different sources.

This is a Kilometer underground base beneath Archuleta Mesa and the Jicarilla Apache Indian Reservation since 1976, one of the areas of the U.S. hardest-hit by mutilations. This installation is operated jointly as part of an ongoing program of cooperation between the U.S. government and EBEs. There are also underground bases at Kirtland and Holloman Air Force Bases, as well as, at scores of other bases around the world, including Bentwaters, England.

Back to the base under discussion, "Archuleta Mesa" we have the following data on that base. The base is two and a half miles Northwest of Dulce, and almost overlooks the town. There is a level highway thirty-six (36) feet wide going into the area It is a government road, and one can see telemetry trailers and five (5) sided buildings with a dome. Next to the dome, to the North there is a launch site. There are two wrecked ships there. One can see thirty-six (36) feet long oxygen and hydrogen tanks near them. The ships that we got to, near the tanks, were atomic powered with Plutonium pellets. Refueling of the plutonium is accomplished at Los Alamos.

The base has been there since 1948. The base is 4,000 feet long and helicopters are going in and out of there all the time. In 1979, something happened and the base was temporarily closed. There was an argument over weapons and our people were chased out The Aliens killed sixty-six (66) of our people and forty-four (44) people got away. One of the people who got away was in fact a CIA agent who, before leaving, made some notes, got some photos and video tapes, and went into hiding. He has been in hiding ever since, and every six months he contacts each of five people he left copies of the material with. His instructions were that if he missed four successive contacts, the people would do whatever they want with the materials.

Somehow, a description of the Dulce Papers was issued, and was received in December 1987 by many researchers. The Dulce Papers were comprised of some twenty five (25) black and white

photos, a video tape with no dialogue and a set of papers that included technical information regarding the jointly occupied U.S. and Alien facility one (1) Kilometer beneath the Archuleta Mesa near Dulce, New Mexico. The facility still exists and is currently operational. It is believed that there are four (4) additional facilities of the same type, one being located a few miles to the Southeast of Groom Lake, Nevada

A general description of what these papers contain is that they contain documents that discuss Copper and Molybdenum, Magnesium and Potassium but mostly papers about copper. Sheets of paper with charts and strange diagrams. Papers that discuss Ultra Violet light and Gamma Rays. These papers tell what the Aliens seek, "The Secret of The Metagene" and how the blood, taken from cattle and some humans is used. They tell why some Aliens seem to absorb molecules to eat by putting their hands in blood, sort of like a sponge, for nourishment. It's not just food they want, the DNA in cattle and humans is being altered.

Why a "Type-One" creature is used as a Lab Animal, and how to change the atoms to create a temporary, almost human being. It is made with animal tissue and depends on a microcomputer to simulate memory, a memory the computer has withdrawn from another human being, creating some kind of Clone. The almost human being or Clone is a little slow and clumsy. Real humans are used for training, to experiment with and to breed with these "almost humans". Some are kept in large tubes, and are kept alive in an amber type liquid.

Some humans are brainwashed and used to distort the truth, certain male humans have a high sperm count and are kept alive for that reason. Their sperm is used to alter the DNA and create a non-gender being called 'Type-Two'.

That sperm is grown in some way and altered again, put in wombs. They resemble ugly humans when growing but look normal when fully grown, which only takes a few months from Fetus size, but they have a short life span, less than a year.

Some female humans are used for breeding, and subsequently, countless women have had a sudden miscarriage after about three (3) months into the pregnancy, and some never know they were pregnant, others remember contact some way. The fetus is used to mix the DNA in types one and two. The make-up in that fetus is taken at three (3) months and grown elsewhere.

There are some pen and ink reproductions of what one of the wombs look like i.e. two (2) by four (4) feet, an illustration showing one of the tubes in which the "almost humans" are grown, a page showing a simple diagram of crystalline metal, pure gold crystal, and what looks like either a genetic or metallurgical diagram or chart Also attached is what looks like an X-Ray diffraction pattern and a diagram of hexagonal crystals, with a comment that they are best for electrical conduction. It would appear that the last half of the material in the papers applies to the super crystalline metal used for hull structure, or something along that line.

Obviously, this is all rather bizarre from a certain point of view, any point of view, in fact, material that is supported by years of descriptions and multitudes of corroborations must mean something, especially when compared against what seems to be going on. It is apparent from this, and other data that has been accumulated over the years, that there are underground bases and tunnel complexes are all over the world, and that more are being constructed all the time.

Many of you may recall the "Shaver Mysteries" and inner-city stories, well, all that is true. There are cities down there, amongst other things, and some of them have nothing to do with the main subject of this document. They've been under there a long time.

Let's change direction for a moment, one individual by the name of Lew Ten has been working on some ideas regarding Geomagnetic Anomalies, which UFOs may use. We will go into what he has discovered, although the concept of the relationship is not new, and let you judge that for yourself.

After purchasing Aeromagnetic and Gravitational Anomaly Maps for the United States Geological Survey, it became evident that there was indeed a valid connection between these areas and UFOs. Mr. Ten gave a lecture in Arizona about that relationship, and was harassed by the FBI, and told that the information was and is sensitive. Mr. Teri took the hint and declined to talk publicly about it to the degree that he had been doing. Both the aeromagnetic and gravitational (Bougier Gravity) maps indicate basic field strength, as well as areas of high and low field strength.

The areas of maximum and minimum field strength have the following:

- All of these areas have frequent UFO sightings.
- All are either in Indian Reservations, Government land, or Government is trying to buy up the land.
- Many of them, especially where several are clustered together, are suspected base areas and/or areas where mutilations and abductions have historically taken place.

In these observations, Mr. Teri has gone far, but he has gone a little further in noting that there are times when UFOs are seen in these areas. Through painstaking research Mr. Teri found that the sightings, as well as, many abductions and mutilations occur:

- When there is a New Moon or within two (2) days before a New Moon.
- When there is a Full Moon or within two (2) days before a Full Moon.
- At the Perihelion (when the Moon is closest to Earth) or within two (2) days before the Perihelion.

There seems to be no concrete explanation for the coincidence of the times and the events, but appear to be true.

Grey, Rigelian principal bases:

- United States of America (Earth)
 - Fairbanks, Alaska
 - Groom Lake, Nevada
 - Dulce, New Mexico
 - Utah
 - Colorado

- California
- Texas
- Florida
- Georgia
- Maine
- New York
- New Jersey
- Wyoming
- The Atlantic Ocean (Earth)
 - Wavenest
- The Moon
 - Luna-1
 - Luna-2

Obs-1 - No report for bases at Europe, Asia, Oceania, Africa, Central and South America

Obs-2 - No information about Nordic bases or any other Aliens.

Project BETA - The Study of Grey Psychology

The Rigelians, either through evolvement or because the humanoid types are constructed, will exhibit tendencies for bad logic. They appear to have more frailties and psycho weaknesses than the normal humans. The Rigelians are not to be trusted, because of the Rigelians apparent logic system, a key decision cannot be made without higher clearance. All are under control of what they call "THE KEEPER", yet it would appear that even this is not the final authority. Delays as long as twelve to fifteen hours can occur for a decision.

Because of this apparent control, individual instantaneous decision making by the Rigelians is limited. If their plan goes even slightly out of balance or context, they become confused. Psychologically their morale is near disintegration. There is a pronounced dissension in the ranks, even with the humanoids, because of their own internal vulnerability, (mind-wise) to each other, and additionally there is a basic lack of trust between them.

They appear to be totally death oriented, and because of this, absolutely death fear oriented, (this is a psychological advantage to us). The prime and weak areas discovered, probed, and tested are exactly what we had thought, their mind, "being their key strength-, and that which they use to manipulate and control our minds.

Manipulated in reverse, by using reverse psychology we could make them face a situation where they would have a vulnerable integrated weakness, we could use against them.

Taxonomy of some Extra-Terrestrial Humanoids

Working under the instructions of the humanoids for Rigel (Greys, type ones (1)), CIA and former Nazi scientists have developed and deployed malignant strains of bacteria and viruses, including AIDS, in order to exterminate undesirable elements of the human population.

The Greys, especially the type ones (1) are almost entirely devoid of emotions, but can obtain a "high" by "telepathically* tuning in the different kinds of intense human emotions, such as ecstasy or agony. Does that explain why UFOs have always been seen in regions of war or devastation, where humans are in conflict?

We have in the United States several offspring of Alien and humans living together, this is part of a sociological experiment by our government. Throughout recorded history, as well as during prehistoric times, there has been constant genetic manipulation of inter-breeding with Uni-Terrestrial survivors trying to save his or her cosmic hereditarily, in order to breed out the less evolved affected survivors. The Nordic races have participated in this form of new beginning, which makes us much more a part of them than we might suppose.

Greys have the ability to camouflage themselves as tall blondes Nordics through mental energy projection. Blondes Nordics never project themselves as Greys. Some Blondes seen with the Greys are physically real, but are prisoners of the Greys, who have either paralyzed them or have destroyed (neutralized) their ability to teleport through time and other dimensions.

Both blondes Nordics and Greys have the ability to disintegrate matter into energy and then reintegrate the energy back into matter. This ability allows them to pass through walls and to transport abductees out of their cars with the doors still locked.

The original Rigelians were the Nordics until they were invaded by the Greys, a parasitic race, who took over and interbred with them against their will. Several blonde Nordics escaped from the Grey takeover of their system and came to Earth because the original Rigelian and Uni-Terrestrials were the Nordics and claim to be the ones who seeded the Earth.

It is because of this common ancestry that terrestrial humanity is of such interest to both the Nordics and the Greys. Greys were and are easily able to impregnate terrestrial human females either on board their ship or while they sleep in their homes. Males need not be manifested in visible form for this to occur.

The conflict between the Nordics and the Greys is in a state of temporary truce, although the conflict between Rigelians and the Sirius Star System is being fought actively. The Nordics with speech abilities will respond violently if attacked or threatened, but the telepathic ones will respond peacefully. Nordics were sometimes mistaken for Angels in earlier centuries. They do not seem to age, and consistently appear to be from twenty five (25) to thirty five (35) years of age.

The Nordics now inhabit the Procyon Star System.

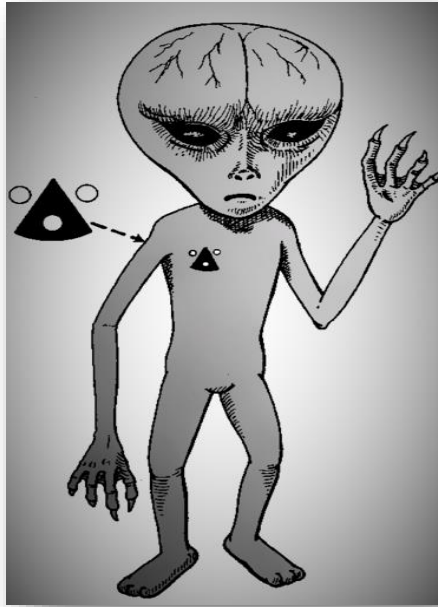

REGELIAN TYPE A

GREYS TYPE A

Type A's are the large nosed Greys from the Rigel Star. These Greys are the ones with whom our Government has a treaty.

DATA

- The approximate height is 3.5 to 4.5 feet tall. Some approximately 5 feet. Their weight is approximately 40 pounds.
- Two semi-rounded black eyes, without pupils. They are large, almond-shaped, elongated, sunken or deep set, far apart, slightly slanted, appearing 'Oriental' or "Mongoloid".
- The head large when compared with the size of torso and limbs.
- No ear lobes or protrusive flesh extending beyond apertures on each side of the head.
- Nose is long and vague. Two nasal openings are indicated with only slight protuberances.
- Mouth is indicated as a small "slit" without lips, opening into a small cavity-mouth, which appears not to function as means of communication or an orifice for food ingestion.
- Neck described as being thin; and in some instances, not being visible because of garment on that section of the body.
- The head is hairless.
- The torso is small and thin.
- Normally they wear a metallic but flexible garment
- Arms are long and thin and reaching down to the knee section of the body.
- The hands have four fingers each, but no thumb. Two fingers appear longer than the

others on each hand. They have some kind of long fingernails. A slight webbing effect between each finger exists.

- Legs are short and thin. Their feet are like an orangutan's feet
- They have no teeth.
- Their skin description is some kind of beige, tan brown, or tannish or pinkish grey color. The texture as scaly or reptilian, and as stretchable, elastic or mobile over smooth muscle or skeletal tissue. No striated muscle. Light perspiration and very particular body odor. Under magnification the tissue of skin structure appears to be a mesh, or like a grid network of horizontal perpendicular lines. They suggest that the texture may be similar to that of the granular-skinned lizards, such as the Iguana and/or Chameleon, and may be similar to at least on other type of alien humanoid.
- No apparent reproductive organs. Perhaps atrophied by evolutionary degeneration. No Genitalia. The absence of sexual organs suggests a system of cloning reproduction may be prevalent.
- The Aliens appear to be formed out of some sort of mold", or sharing identical facial characteristics.
- Colorless liquid prevalent in body, without red cells. No Lymphocytes. Not a carrier of oxygen. No food or water intake is evident or known at this time. It is believed at present that no food may ever be required. No digestive system or GI tract. No intestinal or elementary canal or rectal area described.
- Many variations of anatomy exist.
- Their life span is unknown at this time.

TYPE B

Type B's are the Greys from Z-Reticuli 1. These Greys are also ones with whom our Government has a treaty.

DATA

• Physiology more or less is very similar to that of the Rigelian Greys. They are Male and Female. The differences are they need food for survival. They prefer proteins of dairy meals. They have asexual form of reproduction. The "Orulo" grow outside the female Z-Reticuli 1.



Z-RETICULI 1 TYPE B



Z-RETICULI 2 TYPE C

Type C, one and two, are the Greys from Z-Reticuli 2. These Greys are Alien researchers of us and our planet

DATA # 1

- Physiology is like Z- Reticuli 1's. The differences are at the eyes, they have big black pupils.
- They have ear lobes.
- The Type C number one Greys, have the same type of reproduction as the Z- Reticuli 1's.
- The mouth has small lips and a throat which they can speak from with verbal words.

Z-RETICULI 2 TYPE C

DATA # 2

- The differences are the shape of the head, see the sketch above.

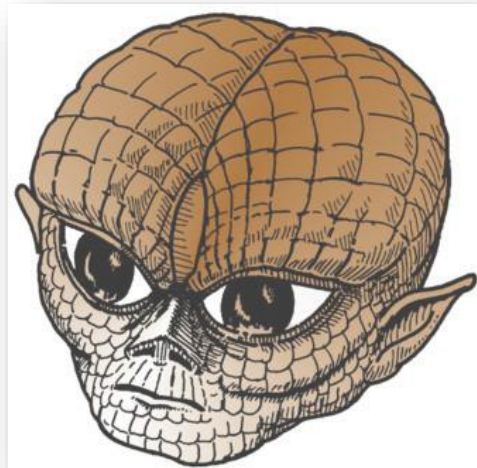

- They eyes and eyeball.
- The Type C, number two Greys, have pointed ear lobes.
- They are smaller than 1st type of Z- Reticuli 2's.
- Their reproduction is accomplished by an egg.

NORDICS TYPE D

Type D's are the Nordics. The Nordics are normally a blond humanoid type.

DATA

- Average Height:
 - Male: 2.0 Meters
 - Female: 1.7 Meters
- Average Weight:
 - Male: 90 Kilos
 - Female: 70 Kilos
- Body Temperature:
 - Male: 98.6 degrees Fahrenheit
 - Female: 98.6 degrees Fahrenheit
- Pulse/Respiration:

- Male: 72.5/16
- Female: 72.5/21
- Blood Pressure:
 - Male: 120/80
 - Female: 80/50
- Life Expectancy:
 - Male: 60 Earth Years
 - Female: 23 Earth Years

They come from several places, but the main places they come from are the Pleiades and Orion star system.

NOTE: I have found some smaller Nordics with dark skin or dark hair. There is still not enough data about this offshoot.

ORANGES TYPE E

Type E's are the Oranges. The Oranges are normally a red haired humanoid type. They come from the Barnard Stars.

DATA

- Average Height:
 - Male: 1.7 Meters
 - Female: 2.0 Meters
- Average Weight:
 - Male: 70 Kilos
 - Female: 50 Kilos
- Body Temperature:
 - Male: 91 degrees Fahrenheit
 - Female: 91 degrees Fahrenheit
- Pulse/Respiration:
 - Male: 242/61
 - Female: 242/61
- Blood Pressure:
 - Male: 80/40
 - Female: 80/40
 -
- Obs: They can use a beard sometimes.
-

ALIEN TECHNOLOGY

- Alien Crafts with Dimensional Factors and/or Dimensional Origin
- The U.S. Government and Alien Technology
- The Implant or S.B.M.C.D.
- Aliens and the Electromagnetic Spectrum

- Alien Artifacts used at Mutilators
 - The Biological Scanner
 - The Spray Applicator
 - The Field Reader Tube
 - Surgical Scalpels
 - Skin-Grafting Lasers
 - Blood Attracting Device

ALIEN CRAFTS WITH DIMENSIONAL FACTORS AND/OR DIMENSIONAL ORIGIN

To understand this concept, you have to realize we live in a Universe made of ten (10) Dimensions; nine (9) Spatial and one (1) Temporal. On Earth though, we just use four (4) Dimensions; three (3) Spatial and one (1) Temporal, because on Earth six (6) dimensions are compacted at one Abstract Dimension.

Following the theories of two physicists Dr. John Schwartz, (USA) and Dr. Michael Green, (England) the Particles of our Atomic Structure have the consistency of ten (10) dimensions. For the system to be established, after the BIG BANG, the dimensions collapsed and created the compacted effect of the six (6) other dimensions into one dimension.

The Aliens used this knowledge, which they call the NORDWAG FACTOR, which increases one large field of acceleration or particles and recreates a new dimensional spaces. This means that the inside of the Alien craft is much bigger than the outside size to the Alien craft is in size and dimension.

Some similar aspect affects over 3rd Dimension (Space) and 4th Dimension (Time) to the six (6) other dimensions: MULTIVERSE (MULTI-UNIVERSE Theory) and not a single UNIVERSE Theory.

Universe is a single part of the total of the MULTIVERSE.

THE U.S. GOVERNMENT AND ALIEN TECHNOLOGY

Of course they (Aliens) have given high technology to the Government but how do scientists, (like myself) know the difference between a toy or a real sophisticated device if they never have seen one before? They give us primitive concepts in computer systems (micro-chips and integrated circuits) and we improve much faster than they expect we can.

After this, Aliens have been much more careful about what "Toy" they give us because we have demonstrated that we can turn a "Toy" into High Technology in short order.

The Main interests of the U.S. Government is to collect all possible Alien information in,

- science (especially new sources of energy)
- technology (specially beam weaponry and tactical Aircraft)
- medical (extend the life expectancy of Humans and total elimination of deadly infirmities, i.e. for elimination of the weak" people from our society)
- Intelligence (especially in mind control)

All of these objectives are still ongoing.

The S.B.M.C.D. or Implant

The Spherical Biological Monitoring and Control Device (SBMCD) is a techno-organic enhanced synaptic processor powered by a micro-positron flow that controls or mimics the functions of the human nervous system with micro-relay's duplicating the operations of brain engrain patterns.

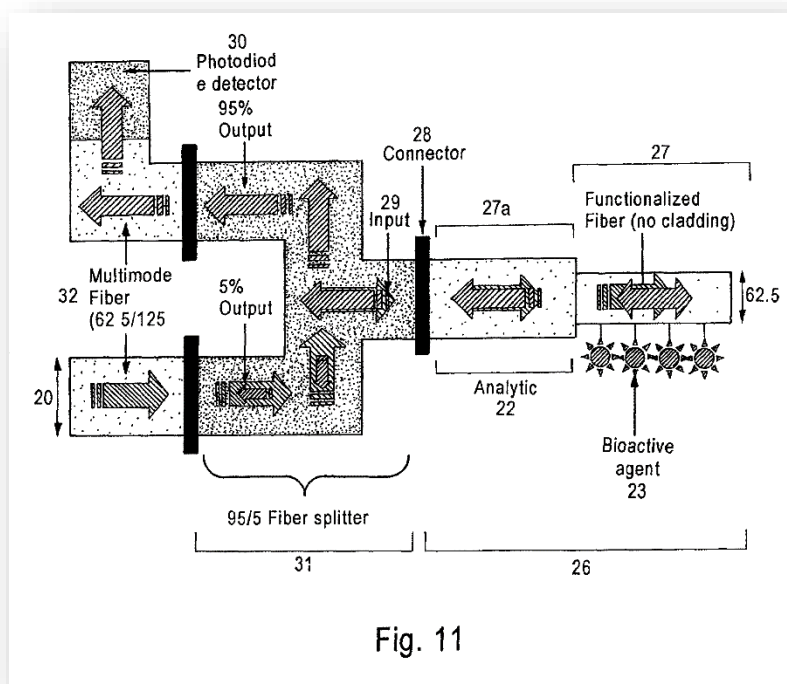

Fig. 11

Multiband Micro Receptor/Transmisior

Unit's Auditory Sensors maintains a constant monitoring of wavelengths that extend into the ultrasonic frequency range as well as being able to detect sound of only a few db in strength at short distances.

Central Power Nucleus.

Here is where energy is released to power the unit. This energy is generated by the decay of a small quantity of the radioactive isotope strontium 90, and distributed to the entire unit through a unique, direct flow of charged electrons in a fluid nutrient base of a consistency similar to human hemoglobin.

Self-Destruction Device

Will destroy totally the S.B.M.C.D. in case of anyone without access code frequency wavelengths trying to open this module.

A Variety of Micro-Circuited Electro-mechanisms located beneath the Central Power Nucleus, aid circulation of the nutrients, internal solution permitting the efficient transference of power, communications and data.

W (74), V (23)

The unit's enhanced internal/external visual sensors are designed to detect wavelengths of photons (light) ranging from the ultraviolet to the infrared portion of the spectrum.

Neural Stimulator.

The device delivers a phased voltage beam directly into the nerve endings in the brain cortex -phased transducers on either side of main lobes oscillate several microvolts of direct current stimulation per second. Total control of the brain at the end.

The Unit's Auxillary Data Storage Center

Maintains over ten thousand micro silicon wafers, each integrated by direct lead to the micro-positronic simulated brain center, providing instant access to tens of billions of bytes worth of information on call.



Normally the Greys during an abduction make an insertion of a 3mm device (SBMCD) through the nasal cavity into more dose proximity to the brain of the abductee and after implementing subliminal post hypnotic suggestions that could compel the abductee to perform some specific act within the next two (2) to five (5) years.

Normally the SBMCD only can be removed when the abductee dies, trying to remove it while the abductee is alive means certain death.

[Aliens and the Electromagnetic Spectrum](#)

After reading this document, there should be no question at all in your mind, that there are intelligences that can manipulate or materialize any kind of object into our dimension. Let's take a look for a second, at the electro-magnetic spectrum. As you know, our visual spectrum only makes up a small portion of the whole.

Look at what spectrums are involved with UFOs:

- Ultraviolet Spectrum
- Blue Spectrum (UFO entry Field)
- Cyan Spectrum
- Green Spectrum (UFO is Visible)
- Yellow Spectrum (UFO is in a Vulnerable Status)
- Red Spectrum
- Magenta Spectrum
- Infrared Spectrum (UFO is Departing)
- Heat Spectrum (UFO Field)
- Radio Spectrum

If you will relate this to cases that you are familiar with, as far as appearance, Spectrum Shift when in flight, etc. you will see the applicability of the above diagram.

[Alien Artifacts Used at Mutilations](#)

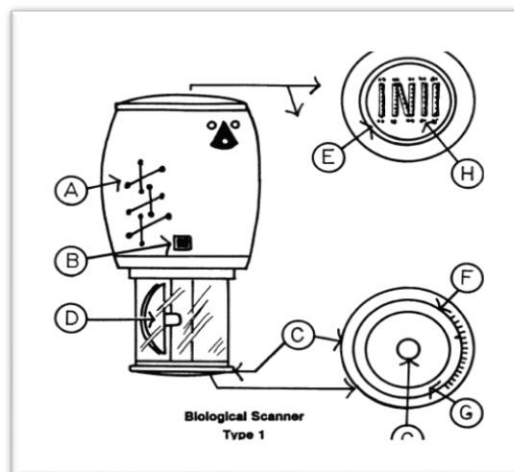

The Biological Scanner

This biological scanner is used for field determination of general medical condition of life forms by sensing body emanations in emission groups of Alpha, Beta, Gamma, Kirlian, Tetha and X Rays.

OBS - refer to files of Majic medicine, advanced diagnoses practices, report for scale calibration and current interpretations of readings.

Specification:

- Overall Length - 6.05cm
- Maximum Diameter - 3,5 cm
- Weight - 230 gr
- Sensitivity ($Em^V AU^2$) to 0.0001 - All
- Reading Groups (Alpha, Beta, Gamma Kirlian, Tetha, and XI Rays)
 - A = Computer (circuits) housing
 - B = Activating Control Switch
 - C = Scanner Housing (#48 Mesh Screen)
 - D = Rotating Scanner
 - E = Reading Dial (increase from bottom to top)
 - F = Life Form Type, Select Scale
 - G = Ground Plane Screen (#48 Mesh Screen)
 - H = Select Range Scale for Different Kinds of Life Forms

The Biological Scanner Type I consists of two (2) parts:

1. Part number one is the scanner head, which you use to active the device by rotating the scanner head, which is enclosed in a microchip mesh sensor network. This will activate the unit.
2. Part number two is the main body that interprets signals received and converts them into an audio readout, which is programmable by twisting the scanner head to the desired position.

The scanner functions much as does a mini-diagnostic center, by sensing the physical emanations of an individual or an organic being, which is in close proximity.

The audio signals indicate either through its period or tone one of ten vital readings:

- Body Temperature
- Blood Pressure
- Pulse Rate
- Respiration Rate
- Basal Metabolic Rate
- Cell Rate
- Lung Capacity
- Heart Activity
- Brain Activity
- Homeostatic Deviation

The scanner is intended for use with a single species, although it has limited diagnostic use on physiologically similar life forms. For visual readout, the scanner can transmit signals to a bio-

computer, the lights on the computer serve the same functions as the oscillating tones, and can be enhanced for a more detailed appraisal of the being if desired.

NOTE: A regular physician must undergo extensive training before being able to "Read" precise information out of the sounds emitted by the scanner, and there is no simple method allowing the layman to do the same.

The Spray Applicator

The spray applicator is a small cylindrical dispenser of epidermal drugs employed by depressing the major axis of the unit between thumb and forefinger. Although it is capable of dispensing a variety of liquids, foams and gels, it is normally pressurized for field use with an organically based flesh-colored compound that acts as a coagulant to stop the flow of blood, as well as, an antibiotic to protect against infections.

A mild local anesthetic deadens pain in the affected area. The applicator contains about five (5) to ten (10) doses, depending on the amount needed in field operations.

The Field Reader Tube

The reader tube is used when the low powered scan is not effective to diagnose a patient's condition, like a species that may possess a thick epidermis. It transmits life readings from a sensor head to four (4) independently, activated lights, which indicate through their intensity or period the following:

- Green: Heart Rate
- Red: Pulse Rate
- Blue: Body Temperature
- Yellow: Blood Pressure

The pointed sensor end of the tube must be placed into direct contact with the patient's exposed skin. Due to the narrow reading range provided by the reader tube, it is suitable for any Life Form.

Surgical Scalpels

Six (6) scalpels are contained within the Surgical Kit, Class: ABR-5, with cutting widths varying from one (1) to five (5) angstrom units. Activated by gripping the cylindrical base, they employ converging Laser beams for a very precise subcutaneous incision.

Skin-Grafting Lasers

The type one (1) low power Laser is used to quickly and painlessly heal external wounds by closing severed blood vessels and nerve endings, while stimulating the victim's anabolism, (constructive metabolism, i.e. regeneration of tissue).

The type two (2) laser can also be used to graft skin, (removed by scalpel from less sensitive parts of the body) onto areas where tissue has been damaged or completely destroyed. This procedure should be followed, as it is really necessary. The Laser is activated by depressing the dorsal bar increasing the pressure, causes an increase in intensity.

The Blood Attracting Device

This device is an emitter of a force-field, like some kind of Tractor-Beam emitter that can focus a wave or particle beam. The device is set for locate hemoglobin cells and attract them through the skin, using the principle of Gravitational Electromagnetic Focus Contention. This device can also be used for repelling, or mutual repelling and attracting mode to seize and hold stationary, repel, or attract even large objects.

The device can operate at a full 180/360 degrees, allowing it to function at almost any angle. Because the beam has its limits the wave particles are short-lived and will disintegrate into by-products at longer range, i.e. in excess of 100 meters.

U.S. GOVERNMENT SECRET TECHNOLOGY

The helicopters themselves have been seen in areas where UFOs were reported, in many countries. In some of the more interesting accounts, the mystery helicopters were seen with UFOs or shortly after UFOs were sighted.

In a documented Mystery Helicopter wave in England, accounts place oriental appearing occupants in an unidentified chopper. Slant-eyed, olive skinned, oriental seeming occupants have been a staple at the heart and at the periphery of UFO accounts for years, significant numbers of the infamous 'Men in Black' (MIBs) have a similar appearance, but very often they are seen as very pale and gaunt men who are sensitive to light.

The most prominent speculative explanations accounting for the mutilation helicopter link, are the following possibilities:

- The helicopters are themselves UFOs, disguised to appear as terrestrial craft.
- The choppers originate from within the U.S. Government Military and are directly involved in conducting the actual mutilations.
- The helicopters are Government Military and are not involved in the mutilations but are investigating them.
- The helicopters are Government Military, and they know about the identity and the motives of the mutilators and by their presence, they are trying to divert attention to the possibility of involvement by the Military.

[Mystery Helicopters and Mutilations](#)

Normally the mystery helicopters belong to the DELTA/NRO division. For a normal mutilation research mission, they send one helicopter with a team of seven agents and two Remote Piloted Vehicles, (RPVs). The RPVs are small devices of look-alike small saucers of three (3) feet in diameter and radio controlled.

Surveillance Devices

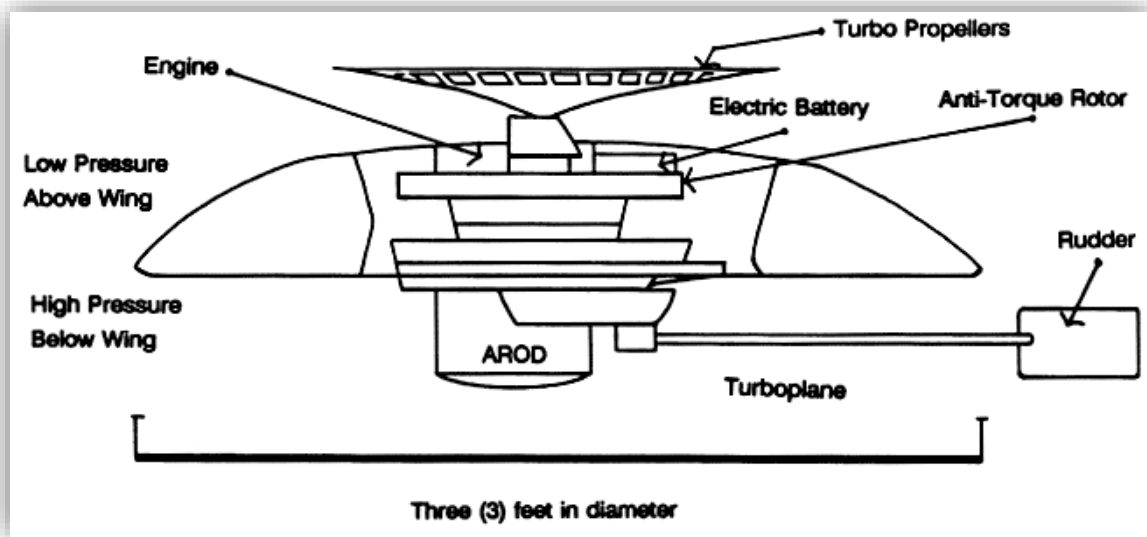

Airborne Remotely Operated Device, AROD

THE RPV

NOTE: This vehicle was created by Aerojet Electro-Systems in California

The RPVs also carry a surveillance robot Airborne Remotely Operated Device (AROD). A flying pizza with a tail, three (3) feet across, carrying a high-tech video camera aboard. Also surveilling the surveillance device from above, is a device known as a High-Altitude Long-Endurance Drone (HALE).

HALE is designed to reach altitudes up to 100,000 feet. The device is powered by microwaves from the main helicopter.

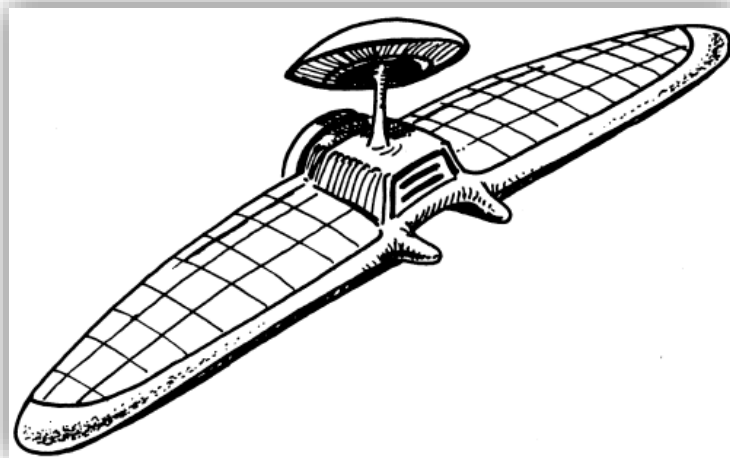

The HALE
ADR 238F

The Teledyne Ryan Aeronautical Corporation is responsible for the mysterious Helicopters or 'XH SHARKS', as they refer to them.

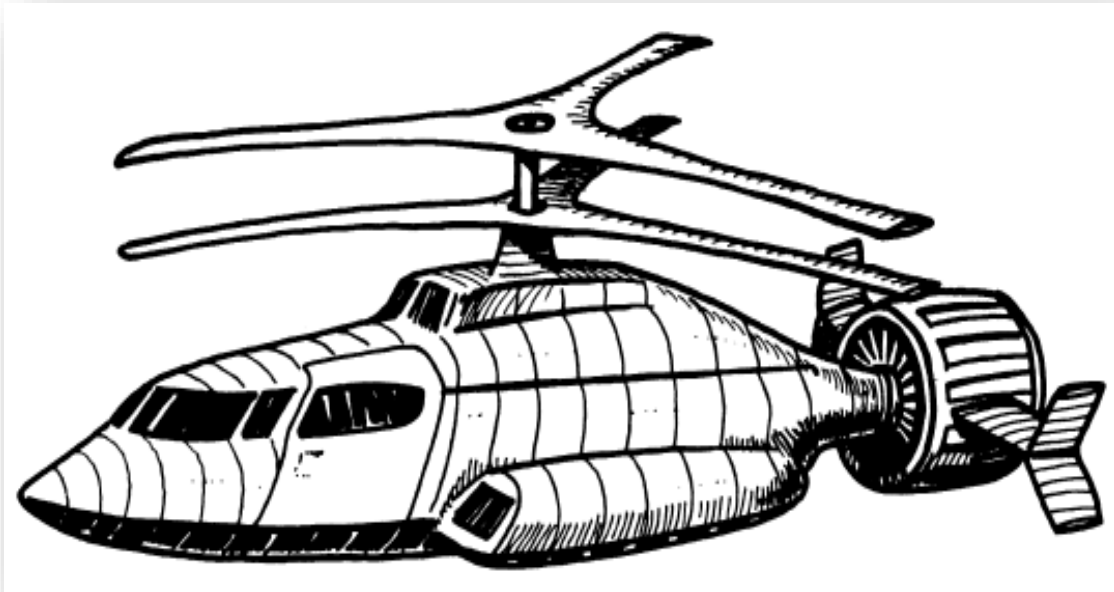

The TRA, SN-75

XH-75D

I believe a cover-up of the capacity of this helicopter, is operating which overrides the real and total capacities and capabilities of this helicopter, but the following is only what I've been able to learn, and may not be the total capacity and/or capabilities.

- Type Rotor: Advanced Blade System, Experimental Research Demonstrator.
- Engines: One (1), 1,825 horsepower Pratt & Whitney engine, Canada J60-3A Turbojet, Turboshaft and two (2) 3,000 lb. (1361 Kg) Pratt & Whitney Turbo's.
- Dimensions: Diameter of three (3) blade, double main rotors are thirty six (36) feet long (10-97m) length of the fuselage forty (40) feet.
- Performance:
 - Maximum Speed (level flight) 276 MPH (445 Km/h)
 - Rate of Climb 5,000 Ft./Sec.

Some helicopters (XH-75D Type) also have a Gravitational Electromagnetic Projector to create a "Cocoon" around the helicopter as a disguise. A 360 degree global arc with a radius of fifty (50) feet, more or less, provides a photonic force-field.

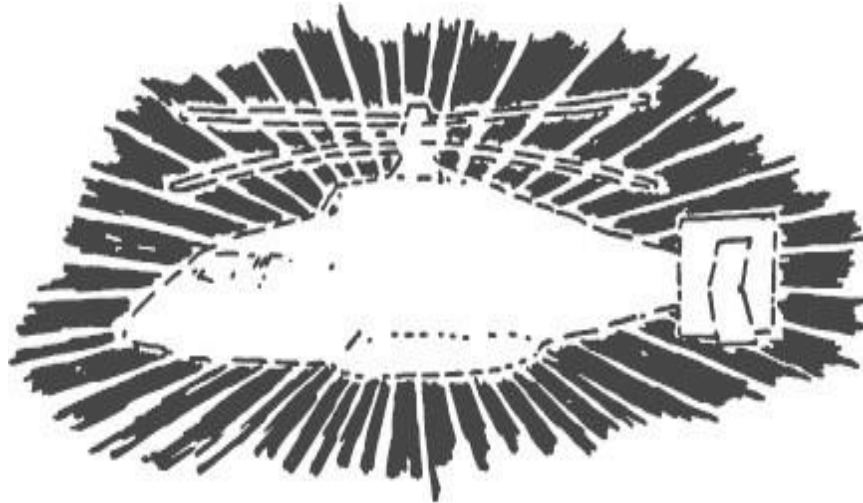

A black Helicopter (XH-75D Type)

When activated, turns into a UFO, next page, with no inertia and no acceleration effects.

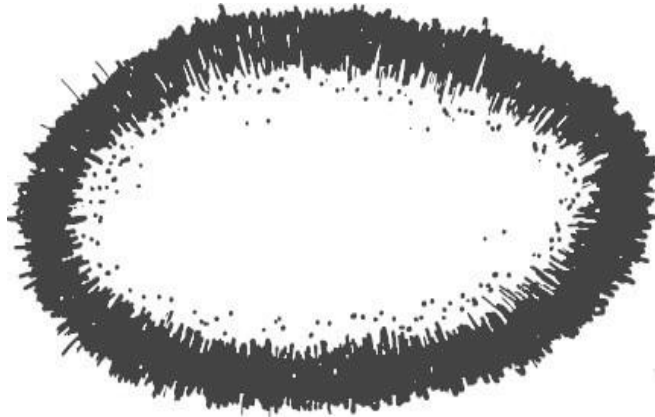

This provides 82% higher protection against attacks.

When used during a normal Mutilation Research Mission, the XH-75D Type black helicopter carries a crew of seven agents, two (2) RPVs, and one (1) HALE drone.

ALIEN ABDUCTIONS

- "The Monitors"
- The Case for Alien Abductions
- The Most Common Areas Examined by the Aliens
- Biological Specimens, Samples usually taken for Abductees and/or Witnesses
- Pregnancy
- Our Genetic Code is under Siege
- The Metagene Factor

["The Monitors" - Abductions](#)

In the fifties, the EBEs, (Greys) began taking large numbers of humans for experiments.

By the sixties, the rate was speeded up and they began getting careless. By the seventies, their true colors were very obvious, but the special group of the U.S. Government still kept covering up for them. By the eighties, the Government realized that it was too late and there was no defense against the Greys.

So programs, (media, sine, TV, comics, commercials, books, magazines, cartoons, etc.), were enacted to prepare the public for open contact with non-human Alien beings. Now at the beginning of the 90's, (1991) these programs are continuing, and working well too.

The Greys and the reptoids are in league with each other, but their relationship is in a state of tension.

The Greys only know the Nordics and the Reptilian Race as their Enemy, (don't confuse the difference between the Reptilian Race and the Reptoids or Reptiloids, because they are completely different races). We will talk more about the Reptilian Race later. Some forces in the Government, want the public to be aware of what is happening, while other forces, (collaborators) want to continue making whatever deals necessary for an elite few to survive the coming conflicts.

The future could bring a fascist "New World Order" or a transformation of human consciousness, (awareness).

The struggle is "NOW", when any active assistance is needed. **PREPARE I WE MUST PRESERVE HUMANITY ON EARTH!**

[The Case for Alien Abductions](#)

GREY types and some NORDICs are on the top of an Alien Force who are bent on abducting millions of people (along our History) against their will, subjecting them to intense medical probing and committing other invasive acts.

These determined Alien species are here, using Earth as a gigantic Breeding Ground. Their accumulated data shows that we're well past the phase where mythic or academic explanations alone will suffice.

Up from the strange, chaotic depths of abduction lore packed into a growing research files and journals, a central theme is emerging.

The bottom line evidence of certain Aliens methodical, ultra-intimate program with Earthlings refutes the cosmic altruism found in traditional contactee literature, and counters the New Age trend of unrealistic idealism that concentrates exclusively on benevolent, spiritual motivations of presumed ET visitations. Scientists are beginning work on the Alien front, even the term "Extra-Terrestrial" stretches the data far beyond its reasonable limits.

This unknown agency exhibiting strictly cold and clinical attitudes toward human beings is unquestionably "Alien"; it's certainly been witnessed often enough in conjunction with UFOs or UFO occupants.

But even lengthy witness accounts that go into great detail about this or that Alien home planet or star cluster fail to factor out the elements of wishful thinking, deception and disinformation to the field of study.

The potential for misleading data attaches itself to abduction research as readily as memories of blindingly bright lights and "missing time" recur as acknowledgements of the experiment itself. The bottom line cannot be discerned beyond the facts at hand. Researchers admit to being stuck in the very earliest stages of divisiveness and confusion, more than anyone else. The abductees themselves have to feel the pain-terrifying literal pain that comes from being at the mercy of an Alien Force whose bottom line agenda largely ignores the fundamentals of human dignity and well-being. But the Aliens do fully comprehend and seem to manipulate the requirements of organic reproductive creation. In this, they are much like us.

We are dealing in a realm that overrides long standing cultural habits of thought and behavior. All we have to work with are the reports that have been allowed to break through the rigid veil that hides UFO information.

Time after time, abductees recall the same sequence of events and observations, their mechanisms of conscious control softened under hypnosis. Many come in "Clean", that is, with little or no previous interest in UFOs and having never heard of or much less read the several books that are introducing the topic to the masses: INTRUDERS and COMMUNION.

The proscribed order of abduction events reveals an industrial sized operation with across the board demographics.

People of all races, most ages and both sexes have had the experience. It's fairly obvious, the researchers maintain, the manufacture of hybrid babies dominates the Alien Agenda It's very extremely structured; they may do a "Million" different things, but they're really interested in one thing alone.

The generic sequence of events as recorded and documented, is as follows:

- Examination
- Egg Harvesting or Sperm Sampling
- Baby Presentations (Only for Females, rare for Males)
- Machine Examinations
- Media Presentations of Idyllic Environments - The abduction sequence is not exact in every instance, but enough leading indicators must be present to qualify the case as one deserving further investigation
- Capture
- Examination
- Conference
- Tour
- Other Worldly Journeys
- Theophany - The delivery of some sort of quasi-religious message or experience
- Return
- Aftermath

This hasn't happened in that many cases, but still deserves particular mention at the moment. A significant number of abductees tend to retain special, almost spiritual feelings about their experiences, even if they were treated roughly or hurt.

Also, recent investigative efforts are hinting that various sources in the intelligence community exhibit an odd preoccupation with the religious angle.

These sources claim they can furnish an "inside track" to greater levels of truth about the UFO Phenomenon, and some investigators consider them trustworthy. They're inexplicable, "Fascinated" with religious side of the things. For some "nasty Alien Races" religion means the better way of mass manipulation and psychologic/sociologic control that they can get, and it works very well!

Researchers feel they are getting closer to having more definitive answers about abductions. A body of evidence that once emphasized matching details, lie-detection and the relative psychology of witnesses is giving way to one yardstick that never fails to command scientific respect. Similarities in form and content are important to know, but ultimate answers demand exterior evidence to bridge the gap between report and reality.

After a close encounter of the 2nd Kind. We have documented the physical and chemical evidence such as soil samples and performed full analysis on these samples. The affected soil was packed in hard, desiccated chunks. To duplicate the effects, analysts had to heat normal soil at 800 degrees Fahrenheit for six (6) hours. This is one kind of physical evidence.

Body scars and other medical trauma left in the wake of Alien examinations are perhaps the most incontrovertible evidence we found available. But other developments add more fully to the case for Alien reality. One example is an examination of stained clothing retrieved from an abductee just after her experience. The clothing awaits spectrograph[^] analysis. The results of this analysis can tell us what kind of residual stains can appear, this again is additional physical evidence.

If large numbers of doctors in conventional gynecological practice were to be exposed to abduction data, a whole new subspecialty would be inevitable. Many women abductees indicate that the Aliens tampered with their reproductive organs, if not actually committing a form of technological RAPE. Some women abductees are plagued with stark memories of strange wispy haired offspring whose presence sometimes evokes revulsion and the paradoxical feeling, "That's MY CHILD".

Additionally, we have to talk about the disappearing pregnancies. Abductees as far removed from one another as Brazil to New Hampshire tell nearly identical stories of pregnancies that suddenly appear and disappear and, later, reveal memories of repeated meetings with small, not-quite human infants they are asked to hold or touch.

One theory holds that the Aliens are attempting to learn by proxy the skills of nurturing to aid in the replenishment of their race. I think it's purely physiological. In some way we don't understand the baby is aided and/or helped by the physical touch.

One of the abductees said she felt like a "Human Battery Charger". Elaborate rituals that present babies to parents and attempt to institute some sort of ongoing parent-to-child relationships have been documented, along with descriptions of high-tech nurseries and what looks like unusual incubation apparatuses.

The realm of UFOs is a place where paradox is the norm. It's assumed the Aliens use technology that far outpaces what we have on Earth, yet some of their methods seem low-tech by comparison. According to some data collected about abductions, the Aliens, like humans, have to confront the "World of E.r.r.o.r." in their experiments.

For many years, the "World of E r.r.o.r." appeared primarily as a crashed saucer, recovered pieces, and occupants... what we're finding in the abduction phenomenon is that the factor of error is quite different.

What it boils down to now is someone "sneezing out" something, or an odd metallic object in one's body that no one can make heads nor tails of. Several people have in fact sneezed out objects which may be Alien implants, though so far most of the objects have been lost or thrown away, but a few implants were recovered (which will be discussed later in this document).

The unfolding drama of abduction wouldn't be complete without a token note of "Big Brother" Government paranoia.

Even earthly high tech includes sophisticated mind control techniques and the capabilities to project sights and sounds at a distance. Perhaps not probable, but it's possible that what most researchers consider an Alien orchestrated abduction sequence is actually a carefully scripted, electronically induced perception.

[That means big news to Earth:](#)

If certain areas of the human brain can be remotely stimulated, then it is possible to develop a technology that broadcast over large territories, literally saturating the area with a flood of symbols.

Such a device would be a major tool of social change.

The buzz that human witnesses often hear could be produced by microwave radiation, known to be in the arsenals of governments' darker programs.

A mind control hypothesis could also explain the relative lack of physical evidence, through only an irrational stretch of the imagination might link mind control techniques with what evidence has been documented, i.e. physical traces, unusual metal garments and scarring.

Worth noting, however, is the fact that some researchers pursuing this trail of investigation, have been summarily and sometimes harshly thrown off.

Sporadic accounts of humans assisting with abductions add a chilling note. What we inevitably face, even with the growing evidence, is a mountain of unanswered questions. If and when the mainstream quits denying the presence of UFOs, a well-supported program of tactical research

may ensue. Until then, abduction remains a mystery and the abductees the outsiders whose physical and emotional well-being hinges on its solution.

The data we have about abductions, as derived by conversations with the abductees, that during the abduction process all abductees were scanned with a very sensitive and powerful mental probe which retrieved all personal and private data (name, address, age, profession, psychological pattern, etc.) from the abductees and was readily available to the Aliens for their data bank.

Just a few of these names and addresses go to our government per the Alien/Government agreement. During the process of abduction, a directional subliminal mental command, kept away any other non-interesting witnesses around the area of the Alien craft.

After an abduction occurs, and if we can maintain synchronicity of finding the abductees within 12-24 hours after the abduction, (really not an easy job), we recommend (in the case of a female abduction) a complete Gynecological procedure common to abductions.

In succeeding generations of family exposure to recurrent abductions, we are observing areas of the human body that are consistently and quite visibly affected. This evidence is related to the skin (dermatology) and muscles (musculoskeletal system).

During their experiences, many abductees and/or witnesses will feel a tingling, prickling, or static electric shock type of paresthesia sensation over the skin, followed by paralysis (involving the musculoskeletal system) of the entire body, with the exception of an abductees heart and lungs where minor or no effects may be found.

Scars

The body marks may remain permanently or become transitory in nature over a short duration, healing or disappearing altogether.

In dealing with the skin we find the following evidence:

- A thin, straight, hairline cut, linear, and about 1 to 3 inches in length.
- A circular or scoop like depression, about one eighth to three quarters of an inch in diameter and maybe as much as a quarter of an inch deep.

Rashes

Rashes are seen on the body, most appearing on the upper thorax (chest) area and lower extremities (thighs and legs). Many are geometrical in shape, triangular or circular. Other rashes, similar to chronic inflammations such as localized psoriasis, may be found on other body areas.

First and second degree burns have been sustained in a number of cases and in some cases questionable tumors (Lipomas) have been noticed just beneath the skin.

[The Most Common Areas Examined by the Aliens](#)

Other medically determined patterns of consistency are as follows:

- The nasal cavity
- Ears

- Eyes
- Genitalia
- The umbilical (navel) Region on Females only.

These areas appear to be the physical areas of greatest interest to the abducting Aliens.

Many abductees have described a thin probe with a tiny ball on its end being inserted into each nostril, usually on the right side. The abductees are able to hear a crushing type sound as the bone in this area is apparently being penetrated.

We believe this is when they insert a device for tracking and communicating with the abductee in the future is inserted.

Many abductees will have nosebleeds following these examinations.

AS A PRECAUTIONARY NOTE: We recommend that known or suspected abductees, who are parents, watch their children for any evidence of recurrent nose bleeds that can't be explained. I recommend immediately taking the child to a pediatrician to discover the nature of the nosebleeds.

[Diagram of Female Areas Examined](#)

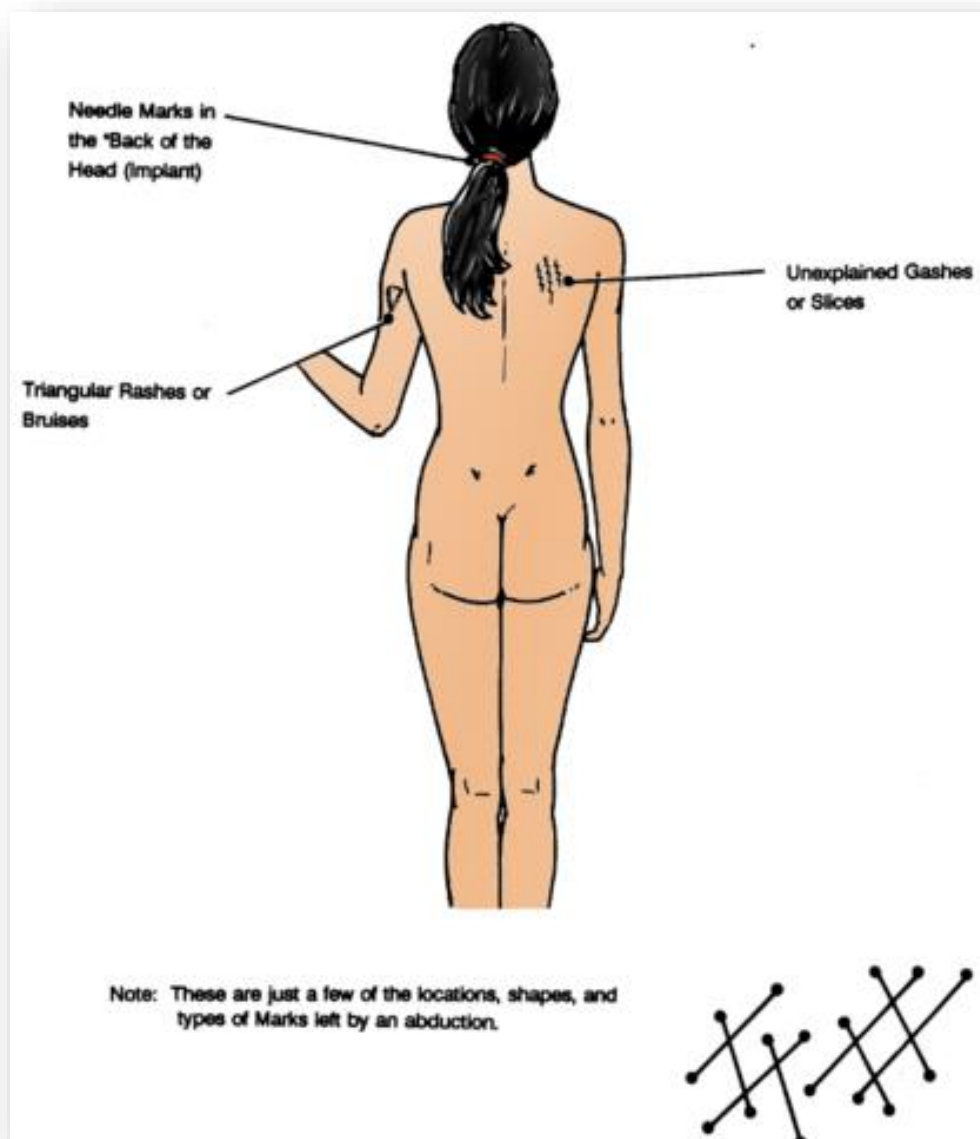

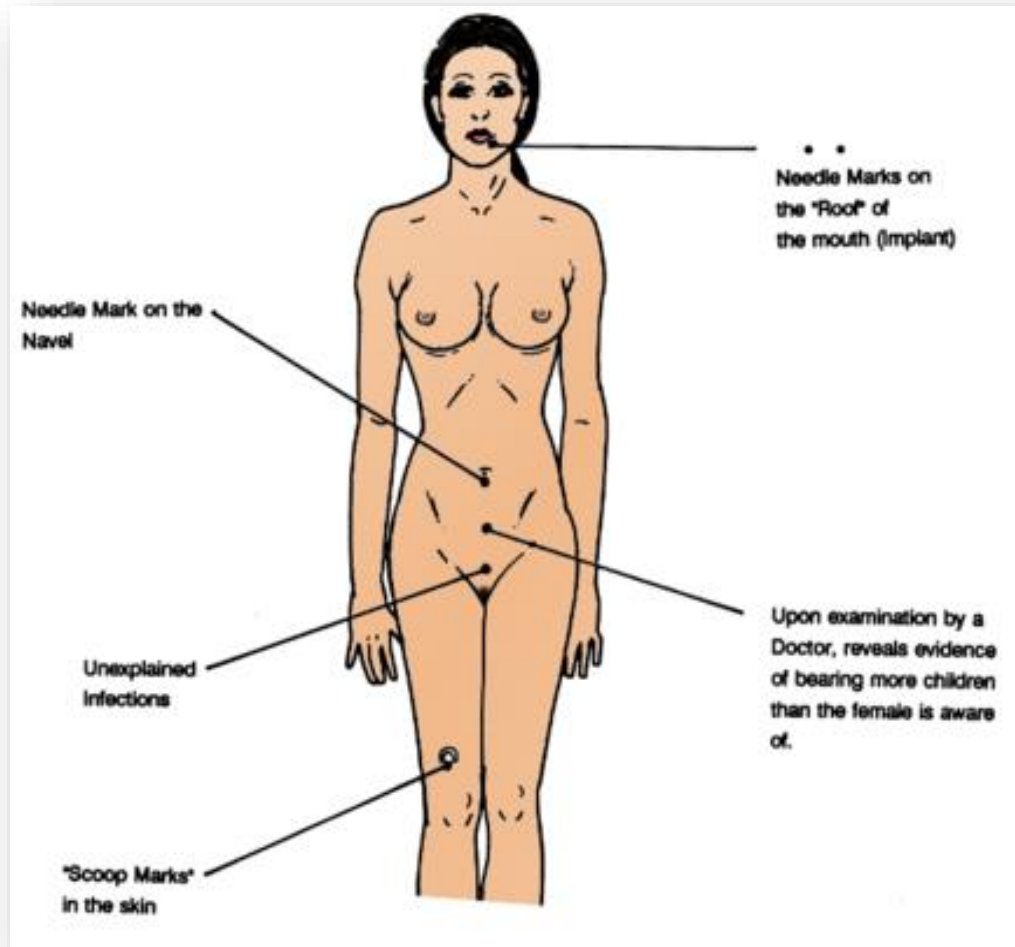

Note: These are just a few of the locations, shapes, and types of Marks left by an abduction.

Many researchers believe that the Alien technology is being used to insert an implant (we talk about implants in other parts of this document) into this area for future tracking of the individual.

It is interesting to note that many of the individuals subjected to nasal probing now have a future history of chronic sinusitis.

Documented evidence has also shown that some abductees have been probed in their eyes and ears with a similar instrument. With eyes being involved, abductees may experience temporary blindness, blurred vision, swollen, watery and painful eyes (photophthalmia), acute conjunctivitis (red and irritated, inflamed eyes that is called "Pink Eye" in lay terms).

There's also some questionable history of these individuals developing cataracts.

Scars have been observed on the calf (including just over the tibia, or shin bone), thigh, hip, shoulder, knee, spinal column and on the right sides of the back and forehead.

Biological Specimens, Samples Usually Taken from Abductees and/or Witnesses

Evidence indicates that Aliens have taken blood, oocytes (ova) from females and spermatozoa from males, and tissue scrapings from their subject's ears, eyes, noses, calves, thighs and hips, when abductees and/or witnesses are asleep or possibly under some form of Alien anesthetic.

There is also some circumstantial evidence to suggest that specimens might have been taken from the following; saliva, aqueous-vitreous humor (eye fluids), cerebrospinal fluid, urine, stool, hair and nails.

We feel that all abductees are given some type of preparation prior to their examinations. Some witnesses have reported receiving "Oral Liquid" medication, others an application of a liquid solution similar to a preoperative "prep" over various parts of their bodies; some report a tranquilizing effect "telepathically" transmitted from the acting Alien examiner, and/or application of an instrument to the head which renders deep relaxation or unconsciousness.

Next we will outline that what we think are the three (3) stages of examinations which abductees are subjected to (through some type of pre-operative anesthesia):

1. First Stage - Pre-Operative Abductees are subjected to some type of twilight sleep state, where they're in a definite trance or daze. This twilight sleep state could be induced by several different things, from the liquid application over the body, a specific conscious suggestion by the Aliens, the Aliens using some form of our hormones or enzymes to stimulate a neurochemical response, or some type of yet unknown technology.
2. One odd note, in connection with this stage that prompts a lot of questions, is why it is that so few abductees remember removing their clothes? Because during the process of light sleep state" they receive a subliminal command to erase the more traumatic moments of the abduction. Some commands are so strong that just a few of the abductees are able to remember clearly their experiences, even when placed under hypnosis to remember.
3. Second Stage - Procedures Physical examinations take place; such as probing, insertion, exploration of the body, taking of biopsies, blood or skin samples.
4. During this phase, the abductees may be semi-conscious as the procedures are carried out. Some actually experience pain. Despite objections, the Aliens appear to be indifferent to their victim's pain and suffering; on the other hand, some abductees at this stage are given heavier sedation to quiet their fears and apprehension and do not recall any pain with these procedures.
5. Third Stage - Postoperative Afterwards, the abductees and/or witnesses say their bodies feel sore or exhausted as if having been involved in strenuous activity; some explain that it feels they've been tossed around or "hit by a Mack Truck".
6. This is similar to the known effects of "Curare" a drug originating in South America that induces therapeutic muscular paralysis. There are specific blood enzyme studies that if performed within 12-24 hours of exposure, can be used to detect any abnormalities of muscular activity.

Several documented physical traces of the abductee experience correlate fairly well with some of our recognized medical procedures.

Most outstanding is one called "Laparoscope, which is a cylindrical, tube like instrument with special optic attachments are placed through a female's umbilical (navel) region for exploration of female organs.

With this particular instrument, a physician is able to observe all female organs to determine if any abnormalities are present, as well as obtain OVA-EGGS from the ovaries.

Most women abductees have felt they were being "blown up" inside, feeling tremendous pressures in the lower abdomen and discomfort in the vaginal area. During the Laparoscopy procedure, approximately two liters of carbon dioxide is instilled into the abdominal cavity. This causes distension of the abdomen, thus allowing better visibility of female organs.

A few women may have residual scarring from the long, needle like instruments placed through the umbilical area.

Pregnancy

In correlation with the Laparoscopy procedure is a new treatment for infertility called Gamete Intra-Fallopian Transfer (GIFT), which treats infertility by placing sperm and oocytes directly into the infertile women fallopian tubes for in vivo fertilization.

In contrast with In Vitro Fertilization (IVF), GIFT facilitates natural physiological processes to achieve pregnancy.

Male abductees report having a tube like device attached to the penis which causes ejaculation for sperm sampling; this is highly uncomfortable to the individual. Most have said they sustain transitory small lesions that disappear shortly afterwards. Others claim to have experienced direct sexual intercourse with an Alien Hybrid Female, ostensibly for the purpose of sperm retrieval as well.

A substantial amount of evidence has been accumulated that female abductees undergo gynecological insemination. These events have resulted in pregnancies, most documented by a positive pregnancy test by gynecologists. In cases of spotting or bleeding with these pregnancies, the physician normally performs a pelvic Ultrasound scan (Ultrasound test to check pregnancy within the uterus) to rule out a threatened miscarriage or missed abortion (failure of the pregnancy to grow).

The test can detect a pregnancy as early as five (5) weeks.

Thus, pregnancy can be confirmed with two different gynecological tests. It should be noted that the government uses the abductees normal doctors to collect most of above and following data, without the patient knowing anything, and in most cases the doctors knowing very little, and threatened that if they ever talk, they will have the licenses revoked "permanently".

In cases we have seen, this is followed up by a subsequent Alien abduction, usually when the pregnancy is approximately 8 to 10 weeks along. During this time, there is a retrieval and/or removal of the pregnancy by the Aliens. The female may or may not experience spotting or

bleeding during this time. What's baffling is how such a pregnancy can be removed intact, without causing death or injury to the extracted embryo by the Aliens.

In order for a particular to continue, several methods would have to be available immediately to sustain life in the extracted embryo.

We suspect that some type of simulated intrauterine growth incubator is used to maintain the pregnancy; or perhaps an Alien Hybrid Female is used, whose role is to act as a surrogate type mother. Techniques for re-implanting the embryo are very difficult for our medical technologies of today.

Several alternative combinations can be speculated with the artificial insemination of female abductees:

1. Alien sperm plus female eggs
2. Male sperm plus female eggs, (in this case the Aliens choose a special type of Male).
3. Male Hybrid sperm, (combination of both A and B) plus female eggs.

NOTE: Female human eggs are apparently needed in all cases.

- Hybridization - They claim that RH O- (O negative) blood is the proof of hybridization and our own science tends to bear out their claim.
- We know that this group of Aliens has a tendency to lie. Since this is a "device" (referred to above) of their invention, they are probably able to manipulate it just like Hollywood technicians manipulate equipment to produce the "Special Effects" or trick hologram photography.

[Our Genetic Code is Under Siege](#)

In focusing on the gynecological and reproductive procedures that have been performed on abductees, we have to come to firmly believe there is some type of ongoing genetic manipulation that is occurring within various family generations.

For purposes of clarification, it is essential for us to use some medical terminology to explain specific facts. The way to genetic manipulation lies within the Deoxyribon Nucleic Acid (DNA) molecules of the human gene cells.

These genes control the reproduction and day to day functions of all cells. It has been estimated that there are probably 30,000 to 400,000 essential genes in the human cells, assembled in lengthy linear arrays that together with certain proteins form rod-shaped structures known as chromosomes. Chromosomes from certain individuals, through certain altering techniques, form a customary arrangement or "Standardized Format" known as Karyotype.

We believe it is the manipulations of the genetic codes on the Karyotype of individual chromosomes that the Aliens are researching, specifically looking for Mutation Patterns. Mutation patterns would allow them to re-arrange the genetic coding on certain LOCI Lin Genetic terminology, the specific site of a gene in a chromosome.

In this manner, they would be able to experiment with a multitude of LOCI in the various chromosomes, thus bringing about new genotype individuals in proceeding generations. Perhaps each succeeding generation of families is subjected to a different comparable type of experimentation by the Aliens.

It is interesting to note, just where the residual scars are located on abductee bodies. Now I would like to pose a new interpretation of the evidence found in our ongoing research of abductees. Many scars are found over the shin bone (tibia) and the hip bone (iliae crest), which are common areas for obtaining bone marrow samples and/or aspirations.

Simply speaking, bone marrow produces the red blood cells in our bodies, and it is significant, in our opinion, that it is through a human's bone marrow and blood that it is possible to study their individual chromosomal pattern.

The timing of abductee's first experiences also correlates to the hypothesis. The marrow of essentially all the bones in the human skeletal structure produces red blood cells until a person is 5 to 6 years old. The marrow of the long bones, except for the proximal portions of the humer, (upper arm bones) and tibiae, becomes quite fatty and produces no more red blood cells after the age of twenty.

Beyond that age, most red blood cells are produced in the marrow of such areas as the vertebrae (Spinal Column) and sternum (Chest Bone), ribs and hip bone (ilia), and as we get older, these bones become less productive.

Most initial abduction experiences occur when the abductee is between the ages of five (5) and twenty (20) years old. Based on these observations, we are probably dealing with two very important phases of an abductee's life as it relates to this apparent Alien exploitation:

- Pre-Adolescent/Teenage Phase
- Initial blood samples, bone marrow aspirations and tissue samples are taken between ages five (5) and twenty (20) years of age. This would be the time frame for specific and early genetic studies on the chromosomes of abductees as a follow-up from another generation with studies performed to see if a certain pattern is consistent within the particular family.
- During this time, some type of implants are inserted so that the individual can be followed and found at some future date, after further analysis of samples have been obtained by the Alien researcher. Some of these individuals may be abducted again, possibly due to a failed implant or for re-confirmation on certain genetic information.
- Adult Phase
- The pattern we are seeing at the present seems to reveal abductees are undergoing some form of ongoing genetic exploitation, implementation or manipulation, such as genetic coding.

- This is where we see the most consistent, most documented procedures of the abduction phenomenon, such as artificial insemination techniques, which are continued on some abductees throughout their reproductive years.
 - Perhaps in their own way, if you believe in the "Space Brother" theory the Alien scientists are meticulously, methodically and clinically re-structuring the human race through procedures of genetic manipulation, so that we will be "designed better" for resolving our own problems, rather than requiring their more direct intervention into our petty world affairs.
 - Maybe there is a double-blind study on the human race ongoing, for reasons known only to the Aliens, who are running the program.
 - Or consider the possibility of this being an Alien scientific research mission, where studies are being performed on technologically less advanced planets.
- All of this is pure speculation and wide open to other theories or hypotheses.
- A new eugenics movement has recently sprung up in Southern California.
- Eugenics is the science dealing with improvement, by control of human mating, of the hereditary qualities of a race or breed.
- These issues that bear on the eugenics movement can be argued both pro and con. However, we feel that overall it is a very emotional issue with implications that could correlate with the Alien agenda, and either certain problems that could very well rival our nation's controversial abortion decisions.
- The techniques of selective breeding which seem to be utilized by the Aliens are beginning to appear in our own culture. For example, Dr. Robert Graham, who founded an organization called Repository for Germinal Choice, has come under heavy attack by his adversaries. Essentially, Dr. Graham's program allows women to "shop" in his repository (Sperm Bank) for a specific type of donor sperm that they can retain for later use in artificial insemination procedures.
- In other words, a woman could select the sperm of a Nobel Prize Winner, an Astrophysicist, or an extraordinary professional such as an Astronaut, Physician, or a Mathematician, etc. It appears that this organization is out to create a new generation of super-intelligent children who will be eventually adults, through the techniques of selective artificial insemination. The socio-economic, political, psychological and theological implications of this controversial new technique, whether put to use by Aliens or humans, go beyond the scope of this document.
 - Exactly what are these implications, you might ask?
 - Only time will tell!

[The Metagene Factor](#)

The Metagene is a biological variant lying dormant in select members of the human race, until an instant of extraordinary physical and emotional over-stress activates it.

That's an ergo-chemical, in response to adverse stimuli.

A chromosomal combustion takes place, as the metagene takes the source of bio-stress, be it chemical, radioactivity, or whatever and turns the potential ergo-response into a catalyst for genetic change. The main focus of the catalyst power is a gland in the middle of the human brain called the PINEAL gland, and the nutrient for increasing the Pineal's action is the adrenalin.

The metagene factor gives the ability of Psionic Power.

The main interest of the Aliens especially the Greys is to understand and control the Metagene for their own race. They try to do this using Biological Experiments to make Hybrids from both humans and Aliens.

They believe perhaps the men from the planet Earth are the deadliest creatures in the Universe. Because only on Earth people are apparently capable of generating the Metagene Factor, which means Natural Psionics ability, "Real Power". The principle races in the Universe are psychologically the same. The pure cold logic is a normal order to most important races.

Basic sameness makes for predictability and security, the enemy one knows, are the ones you can guard against. This is not the case with mankind.

While most are uniformly human, some, many more, apparently, than anyone had dreamed possess a latent tendency towards super humanity, Natural Psionic Abilities. That in itself could prove dangerous for any idea of Alien domination on Earth. But couple of mankind's inherent belligerence with the fact of the Metagene affects, each human is unique and Earth becomes a spawning ground for an unpredictable super-race, "if we have the chance".

Others have already demonstrated an awareness of Man's Potential along the human history (Nordics treat). This is because the Aliens are here to try to control Earthlings before we dominate them, and they want our most important secret: THE METAGENE FACTOR, which is the Aliens only hope.

ABDUCTION BY GREYS

There is a large number of Grey abductees living all over the world. Most are either unaware or just partially aware of their involvement with the Aliens.

Grey abductees seem to be taken for a large variety of reasons, some apparently having nothing to do with the person, him or herself.

They might have been manipulated, to various degrees, for no other reason other than that they were with a person scheduled to be abducted. Others have been abducted apparently only once or very rarely, compared to throughout life. As with Nordic contactees, it would seem that genetics and artificial racial background plays a part in their selection processes.

People have been abducted by Greys for a long time. This contact can exist during generations in the same family, and even cases of the abductee having contacts with same entity during the process of past lives.

All this means, that there may be a clear indication that a large percentage of the human race could very well be a "Sleeping Army", and were picked up only once or twice and implanted, but not generally bothered or contacted throughout their lives.

This suggests that these people are on hold for something, or that they are simply walking transmitters of some kind of information, basically bio-energetic psychosomatic waves, back to the Aliens.

Most Grey abductees are first taken as children, and many adult abductees know or feel their children are being abducted. It would seem that most children who appear to be involved don't want to consider the possibility of actual abduction or think about it at all. It would also seem that the best policy with most children is to leave it at that, not push them to remember.

Hypnotic regression, especially, is considered too much to ask of a child, even adults, actually should not take lightly the decision to have themselves hypnotically regressed to recall abduction experiences.

Children and adults alike, if they are involved, will tell you of their weird dreams and experiences even when they don't believe there is anything going on. Women are frequently abducted largely for reproduction purposes, through some never experience that kind of interaction.

Some of those who are involved in that part of it report that their earthbound, human children that "live with the Aliens" have several different reactions to the situation. Some are perfectly happy with the program as it is, many don't express any opinion about it at all because they don't see it as being anything they can do something about. Some are repulsed by the children and by their own involvement with them.

Some have felt that the children we produce will be used against us. Some of the weapons and aircraft training that abductees are involved in is actually done by the abductee for the sake of the unborn child.

Training the mother as received is thought to be transferred psychically to the unborn child. Things along this line are part of what might inspire some abductees to fear their half-breed children. Others love their half breed children as they would any others.

Many who feel this way would like to recover their children and bring them back to Earth where they would have a better life than with the Aliens.

Many also feel that the children are better off where they are but would certainly like more open contact with them, more interaction with their children.

[Aspects of Bio-Field Differential](#)

The biophysical field of the Grey entities is in opposition to the field of the human body.

The reaction produced by the interface of the two fields can produce a sensation referred to as "body Terror" by abductee Whitley Strieber. A human may or may not experience this reaction, depending on their ability to develop a "Mental Block" to the reaction created by the field differential, on occasions, the same possible reaction with some Nordics is experienced.

The fields emitted by the Greys parallel the type of field emitted by much of their technology. The Greys use technology to amplify the effect of their bio-fields on the humans.

It allows them greater control over the ordinary humans, who may react to the field differential with the human emotion of fear.

Using Internally Generated Tones to interfere with some kinds of Manipulations

Anyone can produce high pitched tones in his or her own head. It would render the manipulative technology inert Just maintain the tone during the presence of the Greys and anyone is capable of arguing with them.

Generation of the tone is an important part of the human defense programming against intruders.

[Awareness Parameters for Tone Maintenance](#)

Since the technology used to manipulate humans encourages relative paralysis of conscious functions, maintenance of tone-interference or other mental techniques must be handled by a form of bridging, or cooperation between conscious and subconscious awareness. Effective use of counter acting techniques depends on an increasing awareness of both states.

The subconscious areas are where all memories are preserved, and all experience there relative to abduction is subject to blocks placed there by both the abductee, (as a programmed response to a function which the Aliens have connected with the survival impulse) and the Aliens. Lucid dreaming indicates a closing of the gap between awareness of both mental areas. Being able to interact with the Greys, on their own turf, so to speak, is a threat to Alien manipulation and control.

[Effects of Multiple Level Alien Manipulation](#)

The most interesting aspect of Alien control and manipulation is that the technology they use allows the separate and distinct manipulation of both the gross and the finer densities that compromise the physicality of the human body.

They have the ability to place a human on a table, put him or her into Delta Sleep, shock him or her with a static charge, separate his or her finer bodies, and manipulate them at will. Manipulation of finer areas that involve the formative forces of the physical body have tremendous effects at the physical level.

They also have the ability to withdraw experience and memory from a human and place that experience and memory into another body, or container, whether the container is a natural or synthetic one.

Manipulations of these type have effects on the ability to have one's consciousness leave the body, emotional response patterns and programming, ability to deal with psychic blocks, and a host of other parameters.

To begin to counteract this, work must be done by the individual to work on expansion of awareness. Connections must be developed between the conscious self and the "second self," which may be the self that is projected astrally.

After a while, the conscious maintenance of the connection begins to combine both conscious memories and memories which lie deeper. Work on self-hypnosis and regression techniques with a qualified individual. These techniques will aid in the process of developing more awareness and control.

Constant experimentation while in Alien presence must be done by the abductee, who must make an effort to note results of various mental manipulations on the Alien control efforts.

Some Major Indicators of Alien Interaction and Possible Hidden Involvement

- Missing Time
- Waking up during the night or in the morning with unusual bodily sensations, such as tingling, numbness, dizziness, heaviness, or paralysis. Any of these are often accompanied by disorientation.
- Nightmares or vivid dreams of Aliens and/or their technology.
- Sleep disorders, also waking up at a specific time.
- Physical marks or evidence of bodily manipulation.
- Repeated sightings of Alien craft
- Clear remembrance of Alien contact and interaction.
- Healing or inexplicable improvement in your physical condition.
- Reactions of fear, anxiety or unusual bodily sensations upon viewing visual images of Aliens or their technology.
- Feelings of having had a communication.
- Unexplained behavior totally inconsistent with previous patterns.

Any or all of the above indicators may appear in combination with other ones. Many of the indicators could also signal a physical problem requiring medical attention.

Clinical psychologists have reported that a significant number of people have been helped by their interaction with alien species, mostly through Alien physical manipulation that resolves a physical condition.

Bio-Conditioning of the Hybrid-Fetus in a Human Host

The nature of the Alien physiology is quite different from that of the human host.

Through the autopsies that we have done on the Greys, it has been found that the tissue is very often a composite that reflects a blending of animal and plant genetics. Some species have black tissues with green blood and appear to function on a light based nutrient system.

Many human hosts have reported mysterious infections, often yeast-like in nature. Through analysis of many cases, it has been pretty well established that the Aliens often purposefully introduce systemic organisms into the human female in order to acclimate the hybrid fetus to the physiological environment of the Alien life to come.

These substances are thought to be micro-fungi and/or micro-viruses.

The implantation of these substances is thought to be critical for some species in their hybrid breeding program.

It is quite apparent that here is no concern for long-term effects of hybrid breeding on the human. They apparently make adjustments during the breeding cycle. These adjustments can include substances which physically wear down the human host, as well as, manipulation of the various fields inherent with the human body.

The question always seems to arise, if these Aliens can produce synthetic tissue, why couldn't they just grow a torso or create a synthetic clone to bear the fetus for them. Why do they have to use humans for this process?

There are two main parts to the answer.

1. The first one is that they need the genetic input. The whole reason for hybridization is to enrich the genetic capability of the organism, for this they need human genes.
2. The second part of the answer is that they need the effect on the fetus or human emotional and psychic experiences. The hybrid being will develop growing sentience, (unlike a synthetic, where the sentience does not extend past the physiologically determined by the matrix, the programming is set) and must be exposed to these factors.

One would then ask why they could not sit around and project psychic energy at a clone, (using artificial ways, of course). The answer is that the emotional component would be missing and the psychic energy not so pure.

The hybrid fetus is extracted from the human most about ninety (90) earth days and development then continues in a totally Alien environment.

The whole process causes premature exteriorization of the human female host, which simply increases the vulnerability to Alien manipulation due to a weakened condition. During the hybrid breeding process, the body of the human female host will be manipulated.

There have been cases where fillings in teeth, which may contain mercury and other metals, have been taken out of the human's mouth in order to seemingly promote the health of the developing fetus.

Abductions Related Medical Anomalies, an Abductee may Experience

1. Abnormal blood cells
2. Implants in the eye, skin, nose and/or anus
3. Diarrhea, mostly in men
4. Constipation, mostly in women
5. Shoulder pain that comes and goes
6. Lower back pain, three (3) vertebrae up, from the lower lumbar
7. Knee pain, in the dip of the knee under the kneecap
8. Rashes, immediately after contact, may be caused by radiation
9. A Lump in the dip of the collar bone at connection to neck, may cause paralysis or semi-paralysis of arm or arms.
10. Artery in the wrong place, may indicate an arterial implant
11. Pregnancy connected with an abduction time period, usually a small fetus
12. A baby may have an unusual appearance
13. A child who has ESP and/or is advanced beyond his or her years
14. An eyelid, which may contract and roll outwards under stress
15. Eyes may be able to see through the closed eyelids
16. Visual marks on a body
17. Scars or geometric forms visually present on the body
18. Scars on the back of the legs for people born in 1943, seems to indicate skin scraping, i.e., cloning
19. Hear a buzz, beep or modulated tones in their ear, when going to sleep
20. When they feel a "Last Breath Feeling", may be just a side-effect of a out-of-body experience
21. Shaking of the bed, in conjunction with the limbs of the their body floating or rising
22. Geometric symbols seen in the mind
23. Tiredness in the morning after a good night's sleep. Feel as though you are worn out, sleep learning
24. Out of body experiences
25. Sudden development of ESP
26. Wryneck, enzyme to the brain, (new development)
27. Extra vertebrae in the neck
28. Egg sized lump on the bottom rib
29. Warts form a geometrical shape after examination, appear to be from some instrument.

INCULCATION DEVICES AND THE PRACTICE OF... MANIPULATION OF THE MIND

CODE: NAR

Learning, Teaching and Assimilation techniques of electronic space societies

- Inculcation Devices
- Inculcation Bar Device
- Inculcation Monitor
- Catecholamine Beta-Lipotropin 9753
- Rapid Inculcation Processes

Through the experience of those who have had and are continuing to have various contacts with non-human entities, we have learned some data regarding these advanced societies. Overall, life appears to be rather regimented, social codes are sufficiently advanced beyond those of the human being, that they become a part of existence rather than the subject of existence.

In electronic space societies of positive orientation, knowledge and data are generally assimilated under duress, in that training and education are accomplished by forceful means, such as implant technology.

Techniques of electronic space society's inculcation, (to teach or impress by force or frequent repetition) is the usual term used.

One of the prime patterns of activity is what is called direct observation.

During this process face to face contact occurs between the Alien species and a volunteer humanoid for the purpose of exchanging cultural information. Direct observation also appears to include various types of medical analysis. Abductees in this situation are actually volunteers, but inculcation methods block their knowing or awareness of their own participation.

Of course this is not the procedure of some Alien races, who take abductees against their will, i.e. the Greys.

Direct observance operational procedures are as follows:

- A human target is sensed.
- The human's ridge response system is examined and checked.
- The craft is allowed to appear to the human, releasing old implant blocks.
- The subject is monitored and picked up when appropriate.

Sometimes a targeted human being will be picked up in childhood and taken to an underground facility for crystal implantation.

They will be monitored through the growth period. In young adulthood, the human is picked up, and the crystals are removed and the human is kind of "Placed in Reserve" for future triggering and employment.

The Andreasson Affair is an excellent case which features these elements.

[INCULCATION DEVICES](#)

Several kinds of devices have been noted by those who have had contact with various Alien species.

[Inculcation Bar](#)

A rectangular box of metal with multi-colored lights displaying a sequence of blue-green-red-green-blue and the numerical sequence of 1-2-3-4-5-4-3-2-1.

The subject lies on his/her back, on a metal table directly beneath the bar. At the foot of the table, level with the surface in a metal console box with cables connecting to the table.

The attendants are dressed in red jumpsuits and the room itself is bathed in red light, except when inculcation therapy is in progress.

[The Inculcation Monitor](#)

This monitor, when coupled with the data banks in the ships computers, can be used to implement the enhancement of a being by infusing abilities through implantation of data. During this process, it appears as if negative mental states are removed and mental barriers are set aside.

The monitor is a modulated catecholine encoded laser beam, which pierces the eyeball of the subject in an earths nanosecond (one billionth of a second).

It resonates down compatible optic frequencies, which sets up harmonic vibrations which disseminate the encoding to the proper receptor sites.

[Catecholine Beta-Upotropin 4753](#)

Is a technical name for a substance often given to the abductees. It has the effect of removing certain body neuronal blocks and at the same time gives a boost to the awareness/intelligence level of the abductee.

It is a mixture and distillation of slightly enkephalins melanocyte-stimulating adrenocortitropic hormone in a neural metastasizing, neuro-transmitting medium; i.e., a cerebral cortex "Roto Rooter".

[Rapid Inculcation Processes](#)

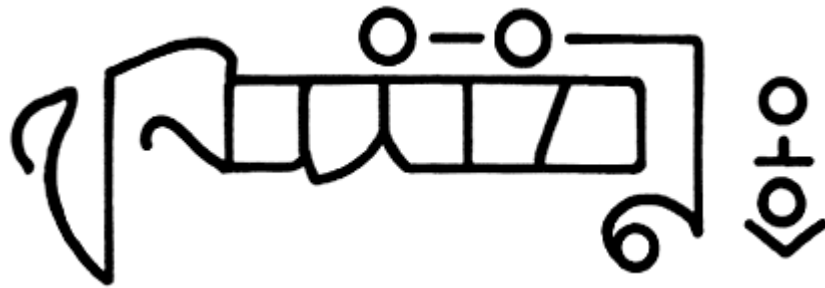

In one method, one dons a helmet bearing wires, (old Zeta Reticulae-2 technology, almost obsolete) and needles.

A crystal cube is put into a niche on top and a type of strobe light flashes in resonance with the brain waves of the abductee. The abductee's head becomes filled with pictures which gradually form a pattern of responses.

The abductee is given a learned motion, pattern, response system, and may be trained in a brief amount of time to do a complicated task.

Sometimes the abductee is hypnotized or made to sleep and a high frequency microwave emission is used as a rapid inoculation method. Rapid Inoculation processes an ocular wave with which to send encoded data into his or her nerve/ridge response system. This data may be triggered later by a pre-arranged stimulus response signal that will be present in the environment of the abductee.

Sometimes the bio-energetic field itself is used as a carrier wave and the data is encoded in sound-code-symbols.

The Grey hybrids, (Rigelians and Betelgeusians) have an interesting variation on which the abductee sits in front of a screen and computer console type and interacts with images on the holographic display.

NOTES:

1. The Ridge Response System = A series of energy focal points formed by the energy streams around the physical body. Ridges can impinge on each other and cause an enduring state. Ridges exist in suspension around the human and are the foundation upon which facsimiles are built.
2. Facsimile = A facsimile is a recording of all perceptions, effort, thought, and emotion experienced by the organism, during any one point in time. It is recorded by the reactive mind. A facsimile can also be considered the physical universe's impression on thought, specifically that section of thought which has a physical universe impression with a time tag on it.
3. Reactive Mind = A reactive mind, are portions of the mind which works on a stimulus-response, which is not under conscious control and which exerts force and the power of command over the being's awareness, purposes, thoughts, body and altiosis.

The reactive mind never stops operating. What is thought to be unconsciousness is always conscious.

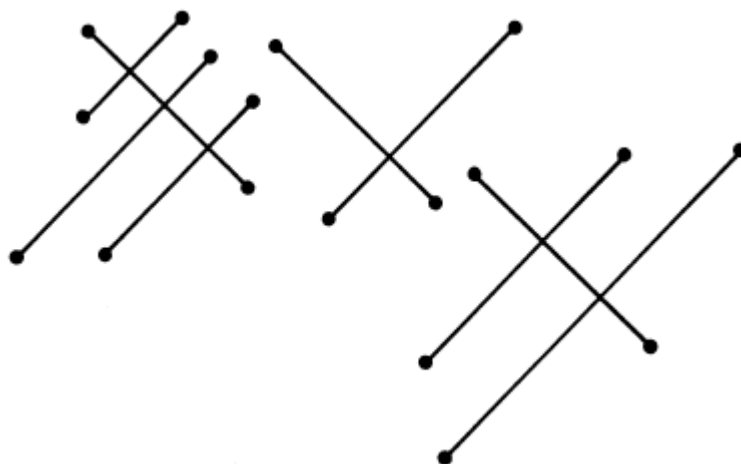

[21st Century Power: Bio-Tech](#)

We are leaving the Era of expendable resources, like oil based products.

The power of the future is renewable resources like Biologically Engineered products. The Dulce Genetic research was originally funded under the cloak of "Black Budget" secrecy, (Billions of dollars).

They were interested in intelligent disposable biology, (Humanoids), to do the dangerous Atomic, (Plutonium) propulsion and saucer experiments. They cloned their own little humanoids, via a process perfected in the Bio-Genetic Research center of the world, Los Alamos! Now they have their disposable slave-race.

Like the Greys (EBEs), the U.S. Government clandestinely impregnate human females, then removed the hybrid fetus's, also after about ninety (90) days, like the Aliens, (for more details about how the Government does their abductions, see volume two of this document, called the PULSAR PROJECT, ATR-25A, CODE: ARAMIS V - ADR 3 -24AT) then accelerate their growth in the lab Bio-Genetic, (DNA Manipulation) programming is instilled, they are implanted and controlled at a distance through regular RF (Radio Frequency) transmissions.

Many humans are also being implanted with brain transceivers, these act as a telepathic channels and telemetric brain manipulation devices. The network, net was set-up by DARPA (Defense Advanced Research Project Agency).

Two of the procedures were:

- R.H.I.C. (Radio Hypnotic Intracerebral Control)
- E.D.O.M., (Electronic Dissolution of Memory)

The brain transceiver is inserted into the head through the nose, they learned this from the Greys.

These devices are used in the Soviet Union and the United States, as well as, Sweden. The Swedish Prime-Minister Palme gave the National Swedish Police Board the right in 1973, to insert brain transmitters into the heads of human beings covertly!

They also developed ELF and E.M. wave propagation equipment, rays which affect the nerves and can cause nausea, fatigue, irritability, even death. This is essentially the same as Richard Shaver's cavern "Telug" mechanism.

This research into biodynamic relationships within organisms, (Biological Plasma) has already produced a ray that can change the genetic structure, heal, or even kill.

Shaver's cavern "Ben-Mech" could heal!

Warning: Manipulation and Control

Fear, Fraud, and Favor >>>> The Pentagon, the CIA, NSA, DEA, FBI, NSC, etc. seek to capitalize on the beliefs of the American Public.

The secret Government is getting ready to stage a contact landing with Aliens in the very near future. This way they can control the release of Alien related propaganda.

We will be told of an interstellar conflict, but what looks real, may be fake.

What is disinformation? Is your attention being diverted by the strategy of a shadow plan? What is a shadow plan? I believe you already know the answer!

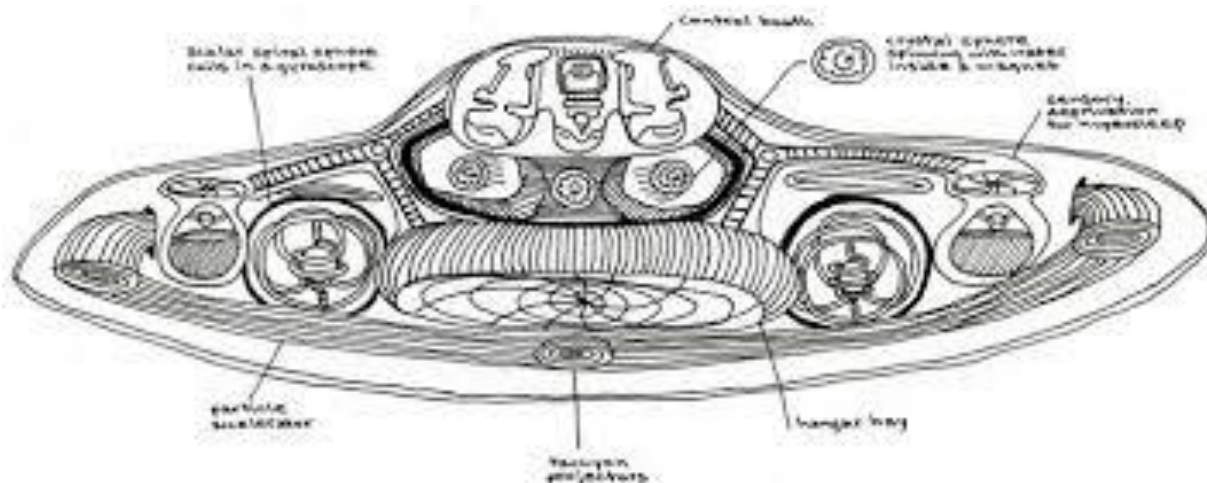



APPENDIX A

ACRONYM DEFINITIONS

- AC - ALIEN CRAFT
- NSA - NATIONAL SECURITY AGENCY
- IAC - IDENTIFIED ALIEN CRAFT
- NSC - NATIONAL SECURITY COUNCIL
- INAC - IDENTIFIED NUMBER OF ALIEN CRAFT
- DIA - DEFENSE INTELLIGENCE AGENCY
- ACL - ALIEN CRAFT LANDING
- CIA - CENTRAL INTELLIGENCE AGENCY
- ACRL - ALIEN CRASH LANDING
- FBI - FED. BUREAU OF INVESTIGATION
- CRL - CRASH LANDING
- UFO - UNIDENTIFIED FLYING OBJECT
- ADR - ALIEN DEFENSE RESEARCH
- R&DB - THE RESEARCH & DEVELOPMENT BOARD
- ONR - THE OFFICE OF NAVAL RESEARCH
- AFRD - AIR FORCE RESEARCH & DEVELOPMENT
- CIA-OSI - CIA OFFICE OF SCIENTIFIC INTELLIGENCE
- NSA-OSI - NSA OFFICE OF SCIENTIFIC INTELLIGENCE

MAP REFERENCES: 65ATN-6

MAP TRACT NUMBER 6

LOCATION ON MAP (COORDINATES) 65 BY A.

OTHER MAJIC – ALIENS TIPS FROM REPORT 13

SRD/28 CODE: ABRAMA 33A/C

- *We confirmed in 1989, the existence of Alien crafts at a hangar on Edwards Air Force Base. The hangar is at North end of the base. It has been guarded by non-Edward's personnel, who are NRO-DELTA personnel. The guards wear a badge that is red with a black triangle on the face of the badge. No one was allowed near the hangar without this badge.*
- *The NRO-DELTA personnel are no longer guarding the hangar, Edwards security forces are guarding it now, and they are instructed to check the hangar each hour and report the status NRO. In addition, they have been instructed never to enter the hangar, even if it has been broken into. The hangar is still locked and no one is allowed inside without special authorization from NRO/DELTA.*
- *We also have confirmed the existence of Alien Materials at another Special hangar at Edward's AFB.*
- *The badge insignias that are on some Alien crafts and Alien Flags, is called a trilateral insignia (TRIADE).*



- *LUNA-2 – Code name for the location of the second most important underground Rigelian base in New Mexico. The base is Alien controlled and NRO, DELTA, and Alien protected. Luna is ongoing.*
- *FAR SIDE OF THE MOON – Is the term used in reference to inside LUNA-2. The LUNA-2 underground base, UFOlogists and some other various people who have stumbled upon this term misunderstood and believed that it was a reference to LUNA-1, the moon base.*

NSA Security System

The *National Security Agency*, (NSA) was created to protect the secretly recovered flying disks, and eventually got complete control over all Communication Intelligence.

This control allows the NSA to monitor any individual through the mail, telephone, telex, faxes, telegrams, and now through on-line computer, monitoring private and personal communications as they choose.

In fact, the present day NSA is the current main expression of MJ-12 and PI-40 pertaining to the Flying Saucer Programs. Vast amounts of disinformation are spread throughout the UFO research field. Any witnesses to any aspect of the programs have their lives monitored in every detail, for each has signed a security catch.



For people who have worked in the program, including military members, breaking that oath could have anyone of the following direct consequences:

- *A verbal warning accompanied by a review of the security oath.*
- *A stronger warning, sometimes accompanied by a brow-beating and intimidation.*
- *Psychologically working on an individual to bring on depression that will lead to suicide.*
- *Murder of the person, which is made to appear as suicide or an accident.*
- *Strange and sudden accidents, always fatal.*
- *Confinement in a special Detention Center.*
- *Confinement in an Insane Asylum, where they are treated by mind-control and deprogramming techniques. The individuals are later released with changed personalities, identities, and altered memories.*
- *Bringing the individual into the inside, where he or she is employed and works for them and where he or she can be watched. This is usually in closed facilities with little contact with the outside world. Underground facilities are the usual place for this.*

Any individual who they perceive to be too close to the truth, will be treated in the same manner.

MJ-12/NSA will go to any length to preserve and protect the ultimate secret, as we will see later, the characteristics of what this ultimate secret would turn out to be would change drastically for it was something even MJ-12/NSA could not predict, actual contact with Alien groups.

How the actual contact between the government and Aliens was initially made is not known at this time, but the Government was made aware that it could be done by an Alien using the right equipment.





\$29.95

LOST CHAPTERS

*From the
Blue Planet Project*

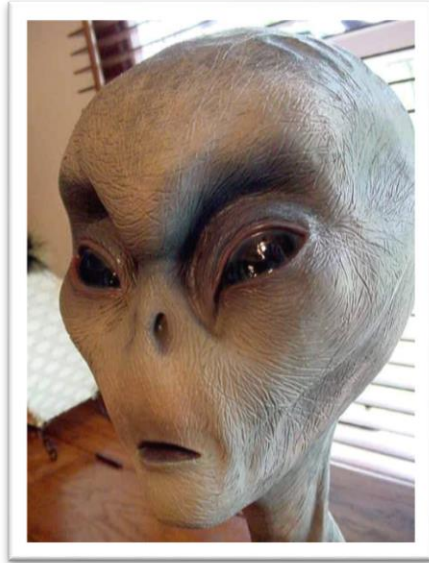

THE LOST CHAPTERS

ISBN: 978-0-9914942-2-4

(C) Copyright 2014 Gil Carlson

Blue Planet Press
Contact us at: BluePlanetPress@aol.com

To discover the rest of the books in this Blue Planet Project Series:
www.blue-planet-project.com/



The material in this book has not been submitted to or approved by any U.S. intelligence agency. If anything is discovered that is considered by your agency to be classified, notify the publisher.

The Secret of the Blue Planet Project Books

As with the original Blue Planet Project Book (If you haven't read it yet, it is available at: <http://www.blue-planet-project.com/>) it is claimed that it is from the notebooks of a government scientist who was contracted by the government over several years to visit alien crash sites, interrogate captured aliens as well as analyze all data obtained from government sources. Then when the government realized either that he had in his possession these notes, and/or that he was going to reveal this information to the public, he supposedly went into hiding out of the country when he realized he was in grave danger.

It was stated that he was involved in these alien and UFO investigations for over 33 years and went into hiding in 1990.

With this last half of the Blue Planet Project Book, just as with the first half, English was a little rough and the spelling wasn't too good. This has led several readers to comment that it couldn't have been written by a scientist, it just didn't have the scientific polish.

Well, there are many different types of scientists, and I have met some whose first language wasn't English. But what we are concerned with here are the facts, of which there are plenty. Some readers have commented that it must be for real, as no one could have an imagined good enough to invent all this stuff! And I have to agree with that.

So try to keep an open mind as we explore this bizarre stuff. We may have a tendency to dismiss this material as being just too bizarre to be for real, but if you look at it closely some it seems to remind us of odd bits of information we heard over the years and may even explain some of those rumors and tales we probably just dismissed as tall tales.

What about what we heard over the years about government cover-ups, false flags, surveillance, and even CIA assassinations that we just couldn't believe at the time, but we are starting to realize that they are most likely true?

And the science fiction of years ago that seemed so way out that it was silly to even consider such a thing as being possible, such as Man going to the Moon or even Mars, particle beam weapons, SDI, aliens actually on our planet, and now they are becoming a part of our world!

Whenever we get ahold of information such as is revealed in this Blue Planet Project Book, we must consider not only is it real or not, but also why it was released.

Is it fiction, fiction written around some basic facts, or fiction released by the government as disinformation to throw some people off the track of what is really happening? Or is it real and a government employee wanted to reveal the public what the government was actually up to?

Paul Bennewitz was anonymously given some tapes by what appears to be a government agent involved in disinformation on such things as Majestic 12. Now either they were similar to what was really going but not the whole truth to send everyone off on the wrong path or the government may just have been using him to spread some actual information so the public gets more used to the idea that there are actually aliens involved in our affairs.

I believe that Mr. Bennewitz actually did stumble upon and record some transmissions that really did originate from UFOs or were top secret communications involving the military in a secret project or a combination of both. Bennewitz was no dummy, He was very savvy when it came to electronics and communications.

The government went to a lot of trouble to make him look foolish and to drive him crazy and they finally succeeded in confining him and giving him shock treatments. If he was just some harmless nut, would the government really care and waste their time with him?

This has been the government's most effective trick over the years, to get the public to laugh at you if you mention seeing a UFO or even believing in them. And it has really worked! How many folks who have witnessed something bizarre in the sky will never say a word for fear of being ridiculed and maybe even losing their job or their standing in the community?

I heard that the founder of the Enquirer tabloid originally worked for the CIA and that they funded the money for him to start it. One of the goals was to run ridiculous exaggerated articles and pictures on aliens and UFOs in order to treat the subject with ridicule so that most mainline newspapers wouldn't touch the subject for fear of being compared to them.

Where did the Blue Planet Project originally come from?

Who is this mysterious Jefferson Souza?

Going back to the 90's, Jefferson Souza and the Blue Planet Project seem to be intertwined, but many doubt that Souza is the author. When The Blue Planet Project Book was first released, no one wanted to take responsibility for it.

The author was described as "Anonymous" and the book was uncopyrighted, with a strange explanation about it being in the public domain because the notes it was based on were government property.

Although there always has been a lot of interest in The Blue Planet Project, it hasn't been available in a printed format in a long time, just a few scattered postings online and mentions in chat rooms and on UFO TV specials.

Then in 2013 the folks at Wicked Wolf Press got ahold of it cleaned it up so it was readable and put out an updated edition. But a month or so later, Amazon dropped all listings for it and posted a notice about it being out of print and no copies available, very interesting!

Maybe The Blue Planet Project really is a hot potato!

Here's an old news clipping I found online which maybe gave him reason to be cautious:

RESEARCHER BEATEN UP BY MIB/CIA -- MAY 1990

Researcher Jefferson Souza [Vegan - Ummo Contactee] arrived at a UFO Conference in May of 1990 bearing information that included data about which corporations were producing helicopters with gravity assist, as well as information about their use in cattle mutilations. Four men appearing like classical MIB (Men In Black), took the documents, and threw him back on a plane to New York.

While Jefferson Souza seems to be the author or at least the person who introduced it to the public, is he the one who was actually a government scientist and wrote the notebooks on which the book is based?

Well, there is a picture of a security clearance ID with his name on it. Plus, there are several things in the life of Souza that parallels the life of the scientist who wrote the notebooks such as his have been in hiding for a long time and he is still very secretive.

From an article on line: According to some stories, Jefferson Souza 'went missing'.

Here's an interesting post on a forum: The fact that there is someone posting on the forum as 'Jeff Souza' and clearly giving the impression that he was the originator of the first published book seems strange to me. Either it is him, or someone posing as him. His joining date was October 2013!

In one of Sousa's posts he states:

The original Blue Planet Project Notebooks were handwritten by their owner at the First International UFO Congress held in Tucson Arizona held from May 3rd thru the 7th in 1991. The notebooks were grey Composition Graph Notebooks with sketches, diagrams, formulas, charts



and information about Extraterrestrial data collected from various sites around the world.

Lt Colonel Wendelle Stevens

The Congress was founded by Lt Colonel Wendelle Stevens, retired US Air Force pilot turned UFO investigator and researcher. Lt Col Stevens was assigned to Wright Field in 1946, and his research on UFO's began there with all of the information about the Roswell crash in 1947. .

Lt Col Stevens was assisted with his Hosting duties at the Conference by his good friend Command Sergeant Major (ret.) Robert O. Dean, who claims he saw a "Cosmic Top Secret" briefing document on UFOs when he worked on the General Staff at SHAPE (Strategic Headquarters, Allied Powers Europe) in the mid-1960s.

The Conference theme was: Extraterrestrials Are Visiting Earth.

Notice something interesting in the above forum posting? The two mentioned above (Stevens and Dean), although not scientists, they could have been the ones passing the info Jefferson Sousa and it was blamed on a scientist to protect the actual leakers!



Latest picture of Jefferson Souza, suspected Blue Planet Project author

Blue Planet Project – The Lost Chapters

The blue Planet Project Book, for the first time, revealed what was really happening with our government's interactions with different alien species.

The depth of their involvement with alien abductions and genetic experimentation was staggering! And on top of that, we learned of the fantastic efforts used to cover up an unbelievable betrayal by our government!

Until the release of The Blue Planet Project in the 90's, everyone was in the dark. Then, even with the amazing amount of info, it was difficult for a lot of folks to comprehend that all this disregard for humanity was possible. Many folks just didn't want to believe it.

And, now it has recently been revealed that not all of the Blue Planet Project info was revealed at that time.

What has surfaced now is almost enough material to be called the second half of The Blue Planet Project Book!

But I like to call it: “Blue Planet Project Book – The Lost Chapters” and I’m sure that you too will find it very fascinating.

And my main concern was to get this together and out to you as quickly as possible. In the original style of the Blue Planet Project, it is published in a spiral-binding format with the original black & white drawings and artwork and notes which may be in a type size that is not as easy to read as I would like, but here it is in the original format going back to at least the 90’s possibly even earlier.

Note that the information on pharmacology seems to be similar to some of the original pharmaceutical drugs first created.

An MD who reviewed this information considered it strange, and told me it was Star Trek drugs. Some of these being mentioned in Star Trek. Did the author of this information get it from Star Trek?

Since it was only part of this drug information that was close to some Star Trek drugs, I believe it was the other way around. I have heard that information that turned out to be in the Blue Planet Project was borrowed in creating Star Trek, so it may also be the same with these drugs.

Could it be that the original basis of our pharmaceutical industry was leaked or given to us by aliens many years ago? And that it was more beneficial in the original form before being altered by the pharmaceutical industry using harmful chemicals from the oil industry?

It is interesting to note that information that appears in Sci-Fi books and movies, turns out later to be used in our space travel and weapon science as well as in many of our everyday products.

Could it be that this scientific information has been leaked by someone in our government to those responsible for writing these books and movies? Or/and is possible that this information was leaked (maybe subconsciously) to these writers by alien entities or they were able to tap into a vast reserve of knowledge out there, such as what many scientists have claimed was the origin of their ideas for great inventions?

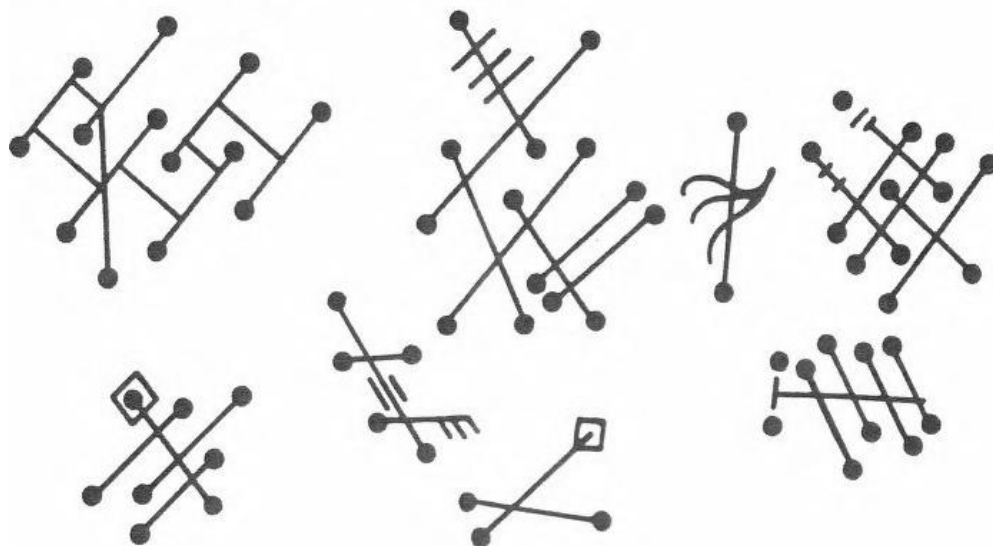

Here Begins the Original, Unaltered Pages:

“The following document is a continuation of the Blue Planet Project, and again, is believed to be the personal notes and scientific dairy of a scientist who was contracted by the government over several years to visit all crash sites, interrogate captured Alien Life Forms and analyze all data gathered from that endeavor. He also wrote notes on or about any documents which he came in contact with, which in any way related directly or indirectly to the organization, structure or operation for the collection of such data.

This individual was discovered to have kept and maintained such personal notes and therefore was scheduled for termination. He narrowly escaped termination by the government and is currently in hiding out of this country.

We believe his involvement in these investigations span over a thirty-three (33) year period. He was soon discovered and immediately went into hiding in 1990.

We modified his personal notes only so slightly, and only when necessary to make them flow together and read correctly.

When you read this document, it may disturb you. The real facts have a tendency to do exactly that, but this information needs to get to the general public. I caution you to use your best judgment when allowing a minor child to read this document.

At this time, to the best of the data we have available, there are at least one hundred and sixty (160) species or races of Aliens from different galaxies, stars and planet we have encountered. You will find as much data (as we have available thru 1990) on each race in the following pages, as each race is discussed. There are still more Aliens we haven't encountered yet, but we feel it won't be long before we do...

There will be more to come later “

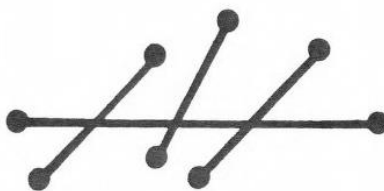

TABLE OF CONTENTS

ALIEN PHARMACOLOGY FOR HUMANS	11
• Altered Adrenalin	12
• Altered Coradrenalin	13
• Cordrazine	14
• Cortropinex	15
• Formazinye	16
• Hyronalinx	17
• Masiform DX	18

•	Melanexy	19
•	Pituitary Hormone	20
•	Ryetalyn (Vrietalyn)	21
•	Sterilex	22
•	Stokalinex	23
ALIEN PSYCHIC ABILITY		25
•	Psionics	25
•	Aura	25
•	Cosmic Rays	26
•	Tewric Energy	26
•	Psychokinesis	26
•	Plasma Reorganization	26
ALIEN CRAFT ENGINES		28
•	The Impulse Propulsion Engine	28
•	The Speed Gear Propulsion Engine	28
ALIEN SERVANTS FOR THE GREYS		31
•	Servents from Rigelian	31
•	Servents from Z-Reticulae 1	33
•	Servents from Z-Reticulae 2	35
MK-ULTRA PROJECT		36
•	The Controllers Affair	38
•	Remote Hypnosis	38
(ii)		
NORDIC PHYSIOLOGY		41
•	The Nordic Body	42
•	Nordic Internal Organs	44
ALIEN LANGUAGE		46
•	Examples of Alien Writing	46
•	Nordic and Pleiadian	46
•	Vegan Ancient and Sirius	46
•	Syrius	46
•	K'Thai and Orion	46
•	Antarian	47
•	The Grey Universal	47
•	The Universal Communication Symbol	47
VEGAN LANGUAGE		48
•	Understanding their written language	48
•	Orthography	48
•	Tenses	49
•	Accentuation	50

• Punctuation	50
• Sentence Structure	51
• Capitalization	51
• Understanding their numbers	51
• Understanding their Time Measurement	52
THE REVISED PERIODIC TABLE	54
THE GREY REPRODUCTION SYSTEM UPDATE	57
THE GOVERNMENTS PHILOSOPHY ON ALIENS	59
• Are the Aliens Hostile or Not!	59
• Non-Hostility Situation	59
• Misperceived Intentions	59
• An Analysis is Needed	59
• Protective Measures?	60
• Possible Benevolence	60
• Polarization Tendency	61
• Long-term Survival	62
A ROSWELL CRASH UPDATE	63
NATIONAL SECURITY AGENCY (NSA) - SECURITY CODES	66



ALIEN PHARMACOLOGY FOR HUMANS

Medications, (drugs) are an essential part of human and/or humanoid patient care. Safe and proper administration of drugs requires sound and current knowledge of their action, side effects, toxicity, onset, and range of dosage. It must be remembered that drugs have the power to help or harm, and

the required knowledge of pharmacology involves integrating a careful understanding of many different disciplines, including anatomy, physiology, pathology, microbiology, organic and inorganic chemistry, sociology and psychology.

Every drug should have a specific use as well as a general classification. Some of the more common classifications or categories of medications are as follows:

Autonomic Nervous System Drugs - work on the autonomic nervous system, which regulates many physiologic tasks necessary for the preservation of homeostasis, a constant internal environment, such as digestion.

Cardiovascular System Drugs - are usually used to treat disturbances in cell metabolism and in the circulatory system, i.e. veins, arteries, capillaries, and the heart muscle.

Central Nervous System Drugs - can act either to increase or to decrease activity of nerve centers and conducting pathways.

Psychotropic Drugs - are usually used in psychiatric treatment and therapy.

Anesthetic Agents - are central nervous system depressants that possess these characteristics:

- They have an affinity for nervous tissue
- Their action is reversible, with cells returning to normal upon elimination of the drug.

Antimicrobial Agents - are drugs which destroy or inhibit bacteria or other harmful microorganisms.

ALTERATED ADRENALIN – Adrenalin is produced in the human brain; synthesized from the medullary portion of the adrenal gland of animals, (specifically cattle), to produce nerve transmission.

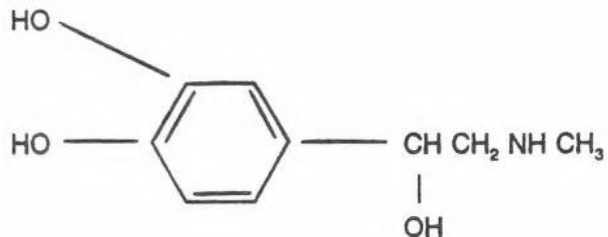

Chemical Composition

USED FOR THE TREATMENT OF RADIATION POISONING.

CLASSIFICATION: Autonomic nervous system stimulant.

- ACTION:**
- Acts on ALPHA and BETA receptors of the brain, (myoneural junctions and autonomic synapses).
 - Calorigenic effect, increases oxygen consumption.
 - Raises blood sugar and production of free fatty acids.

Thus, in response to stress, (fright, fight, or flight responses) there can be an abundant supply of fuel and energy in the body.

CLINICAL

- USE:**
- Constricts blood vessels, thereby stopping capillary bleeding.
 - Vasoconstrictor ability accounts for use of altered adrenalin to relieve congestion in allergic reactions caused by radiation poisoning.
 - Isoproterenol effect leads to alertness, and respiration stimulation.

USUAL

DOSAGE: 0.1 to 1cc (25ug to 1mg)

POSSIBLE SIDE AND TOXIC EFFECTS - Tachycardia; palpitations; dyspnea; pulmonary edema; severe headache; pupillary dilation; anxiety; decreased insulin production; death from overdose.

ALTERATED CORADRENALIN – Developed from Adrenaline to treat severe exposure and frostbite. Originally used in Cryogenic Laboratories.

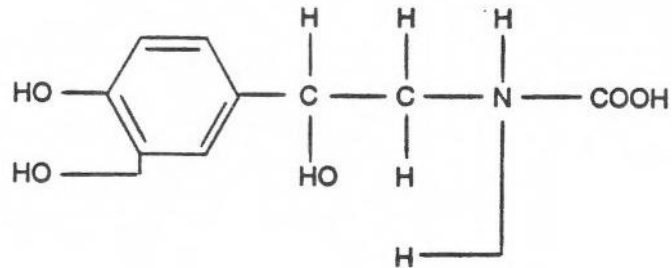

Chemical Composition

USED IN CRYOGENIC LABORATORIES.

CLASSIFICATION: Autonomic nervous system and basal metabolic stimulant.

ACTION: Calorigenic effect, stimulates basal metabolism. This helps the body consume more oxygen and produce more heat for frozen cells.

CLINICAL

USE:

- Used to treat exposure and severe frostbite.
- Maintains regular blood pressure in hypotension.
- Cardiogenic shock, (restores cardiac output).
- Used in conjunction to O₂.

USUAL

DOSAGE: 4cc's

POSSIBLE SIDE AND TOXIC EFFECTS - Edema, subpericardial hemorrhage; tissue necrosis; hypoxia; hypoxemia.

CORDRAZINE – Originally used in cryogenic laboratories to stimulate production of epinephrine, a norepinephrine in the brain, thereby allowing nerve transmission to be restored to the frozen body.

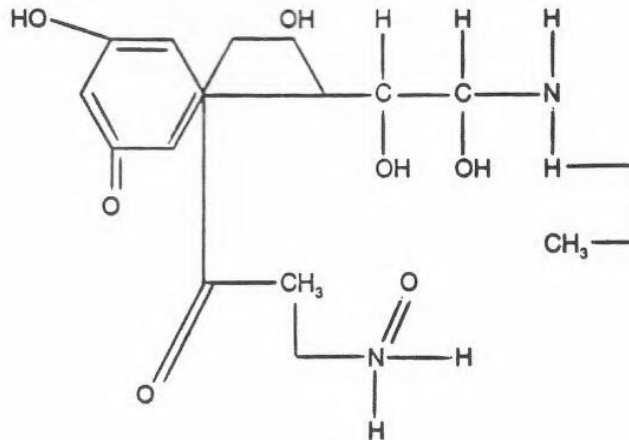

Chemical Composition

USED IN CRYOGENIC LABORATORIES.

CLASSIFICATION: Autonomic nervous system stimulant.

- ACTION:**
- A. Increase in myocardial contraction due to an influx of calcium into fibers, which results in a more complete emptying of ventricles and increase in cardiac work plus oxygen consumption.
 - B. Stimulates production of naturally occurring epinephrine and norepinephrine at the myoneural junctions and autonomic synapses of the brain.

CLINICAL

- USE:**
- Revives nerve impulse transmission in the brain.
 - Increases myocardial contractions, purkinje fiber effect, thereby speeding up the heart's pacemaker action in victims with heart failure or heart flutter.

USUAL

DOSAGE: O, 25cc's

POSSIBLE SIDE AND TOXIC EFFECTS - Elevated blood pressure; insomniac; increased anxiety; paranoia; death from overdose.

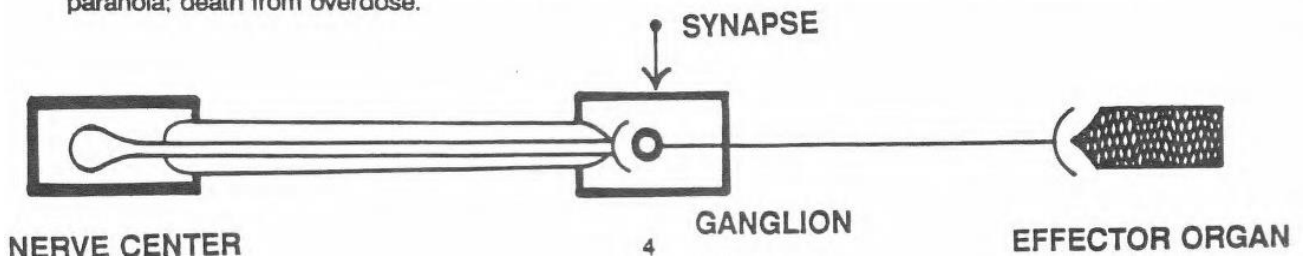

CORTROPINEX

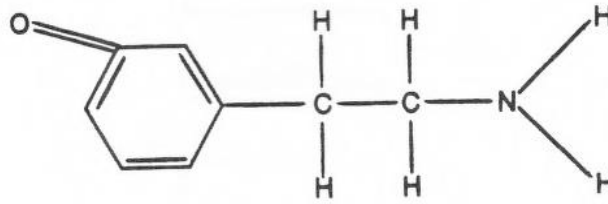

Chemical Composition

CLASSIFICATION: Stimulant.

ACTION: Stimulates the central nervous system, the cerebral cortex in particular. The effects depend on the mental state and personality of the individual. It may fortify a person for prolonged physical and mental exertion.

CLINICAL

USE: Used to treat hyperkinetic behavior in children, and narcolepsy, (overpowering desire to sleep). It decreases fatigue and increases willingness to work, alertness, power of concentration and talkativeness.

USUAL

DOSAGE: 5cc's

POSSIBLE SIDE AND TOXIC EFFECTS - Large doses are followed by mental depression; anxiousness; insomnia; irritability; death from overdose.

FORMAZINE

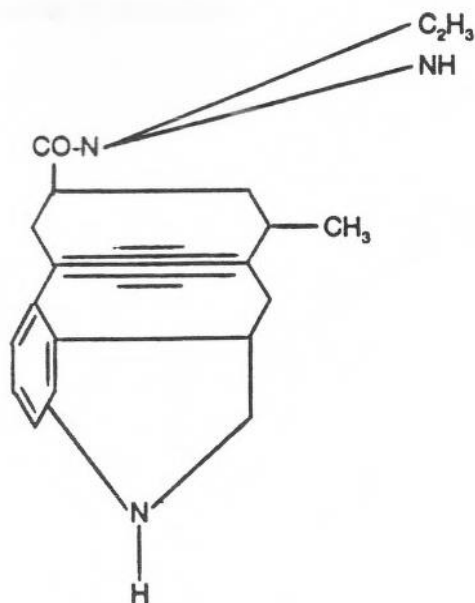

Chemical Composition

CLASSIFICATION: Irritant-stimulant.

ACTION: Stimulates the central nervous system and the reticular activating system. It is a sympathetic agent.

CLINICAL

USE: Most of the irritant drugs exert a stimulating effect when applied in low concentrations, and are used for healing certain skin diseases such as eczema and psoriasis. In large doses, formazinye can act as a stimulant, promoting alertness and lowering fatigue level.

USUAL

DOSAGE: 0.1cc

POSSIBLE SIDE AND TOXIC EFFECTS - Severe irritability; depression; drymouth; hallucinations and disturbance in perception; tachycardia; overdose can lead to death.

HYRONALINX – Replaced Adrenalin for treatment of radiation poisoning because of its quicker action, stronger effects, and its simplicity of production.

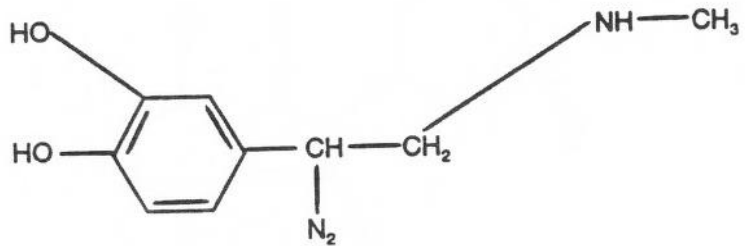

Chemical Composition

CLASSIFICATION: Autonomic nervous system stimulant.

ACTION: Same as Adrenalin.

**CLINICAL
USE:** Treatment of radiation poisoning.

**USUAL
DOSAGE:** 1Occ's

POSSIBLE SIDE AND TOXIC EFFECTS - Refer to Adrenalin.

MASIFORM DX – Developed as a regular stimulant. It was later found to be an antitoxin for saplin.

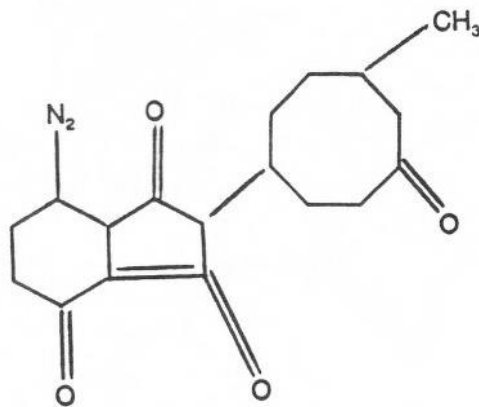

Chemical Composition

CLASSIFICATION: Stimulant and Antitoxin.

ACTION: Envelops or mixes with the poison and prevents its absorption, soothes and protects tissues and sometimes, (depending on the dose) aids in removal of the poison.

CLINICAL

USE: Used as an antidote for saplin, curare and similar drugs.

USUAL

DOSAGE: 10cc's

POSSIBLE SIDE AND TOXIC EFFECTS - Stimulation.

MELANEXY

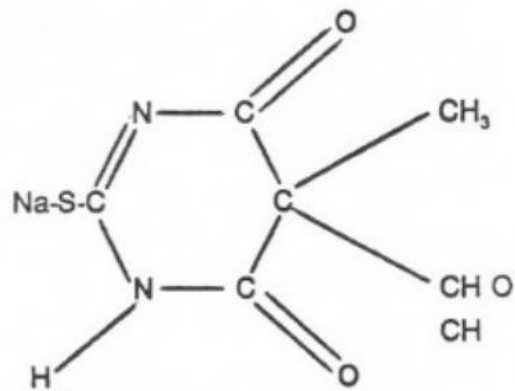

Chemical Composition

CLASSIFICATION: Anesthetic Agent.

ACTION: Melanexy works in approximately five (5) to ten (10) seconds, and is an ultra-short acting barbiturate. It is rapidly taken up by brain tissue because of its high oil-water solubility, shortness of action, results from the drugs being quickly redistributed into the fat depots of the body.

CLINICAL

USE: Used as a pre-anesthetic and for mouth/nose surgery.

USUAL

DOSAGE: 10cc's

POSSIBLE SIDE AND TOXIC EFFECTS - Leaves patient unconscious for five (5) minutes.

PITUITARY HORMONE – It was realized that the element KIRONDE, when broken down by pituitary hormone, promotes PSYCHKINESIS.

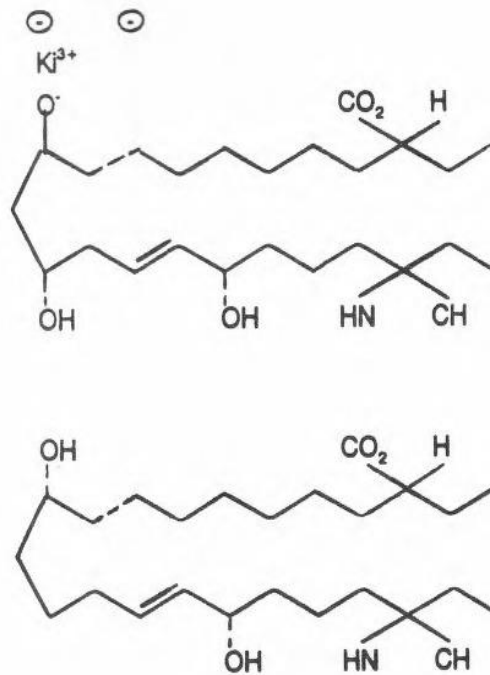

Note: Kironide - Symbol = Ki, Atomic Weight = 348 (Mass number of the most stable isotope), Atomic Number = 139.

Chemical Composition

CLASSIFICATION: Pituitary hormone, (endocrine hormone).

ACTION: Growth hormone, or somatotropin, is controlled by the anterior pituitary, hormones are usually natural chemical substances that act after being secreted into the bloodstream.

Note: The pituitary body is the size of a pea, and occupies a tiny space in the Sella turcica of the Sphenoid bone.

CLINICAL

USE: No real clinical use. Development of Kironide compounds are currently under study at National Security Agency Science Intelligence Division. **Note:** Most hormones are rapidly destroyed, having a half life in blood of ten (10) to thirty (30) minutes.

USUAL

DOSAGE: Not established yet.

POSSIBLE SIDE AND TOXIC EFFECTS - Psychokinetic Effect.

RYETALYN (VRIETALYN) – This is a cure for a dreaded bubonic-like plaque disease, RIGELIAN FEVER.

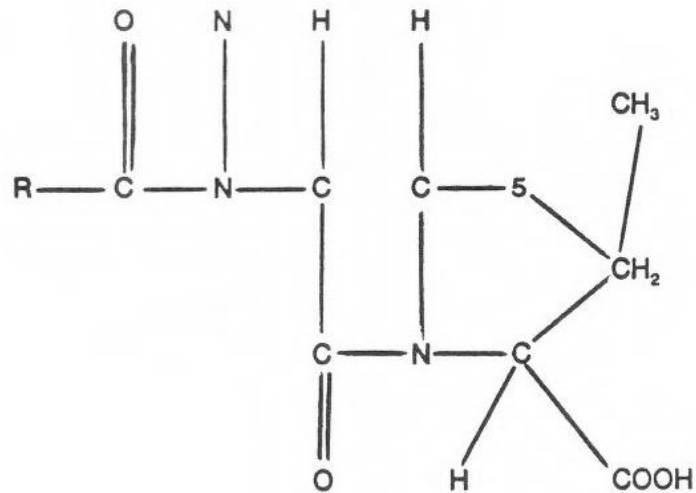

Chemical Composition

CLASSIFICATION: Antitoxin, (Antimicrobial Agent).

ACTION: Inhibition of translation of genetic information and of protein synthesis, as well as, cell wall synthesis, (causing cell of microorganism to lyse). **Note:** The Ryetalyn must be in a pure form to be effective. As little as one (1) part irrilium per 1.000 parts ryetalyn will render it inert.

CLINICAL

USE: Antitoxin for Rigelian Fever.

USUAL

DOSAGE: 1 - 4g

POSSIBLE SIDE AND TOXIC EFFECTS - Allergic or hypersensitivity reactions, may prompt responses such as a rash or an allergic reactions such as anaphylactic shock.

STERILEX

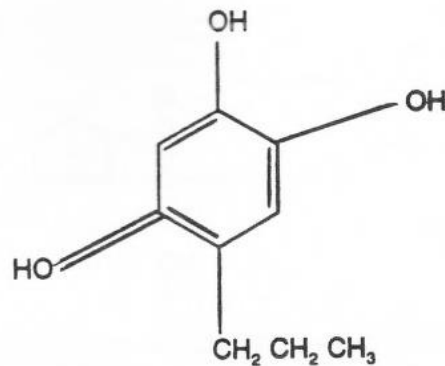

Chemical Composition

CLASSIFICATION: Anti-infective.

- ACTION:**
- Brings about a change in the structure of protein in the microbial cell, (renaturation), which precedes coagulation of the chemical agent.
 - Lowers surface tension of the aqueous medium of the parasitic cell, increasing permeability of the plasma membrane and causing lysis of the cell.
 - Interferes with the metabolic processes of microbial cells.

CLINICAL

USE: Used during surgery or for treatment of wounds, because it produces rapid death of harmful micro-organisms thereby preventing infection.

USUAL

DOSAGE: Depends on the wound or type of surgery.

POSSIBLE SIDE AND TOXIC EFFECTS - None.

STOKALINEX

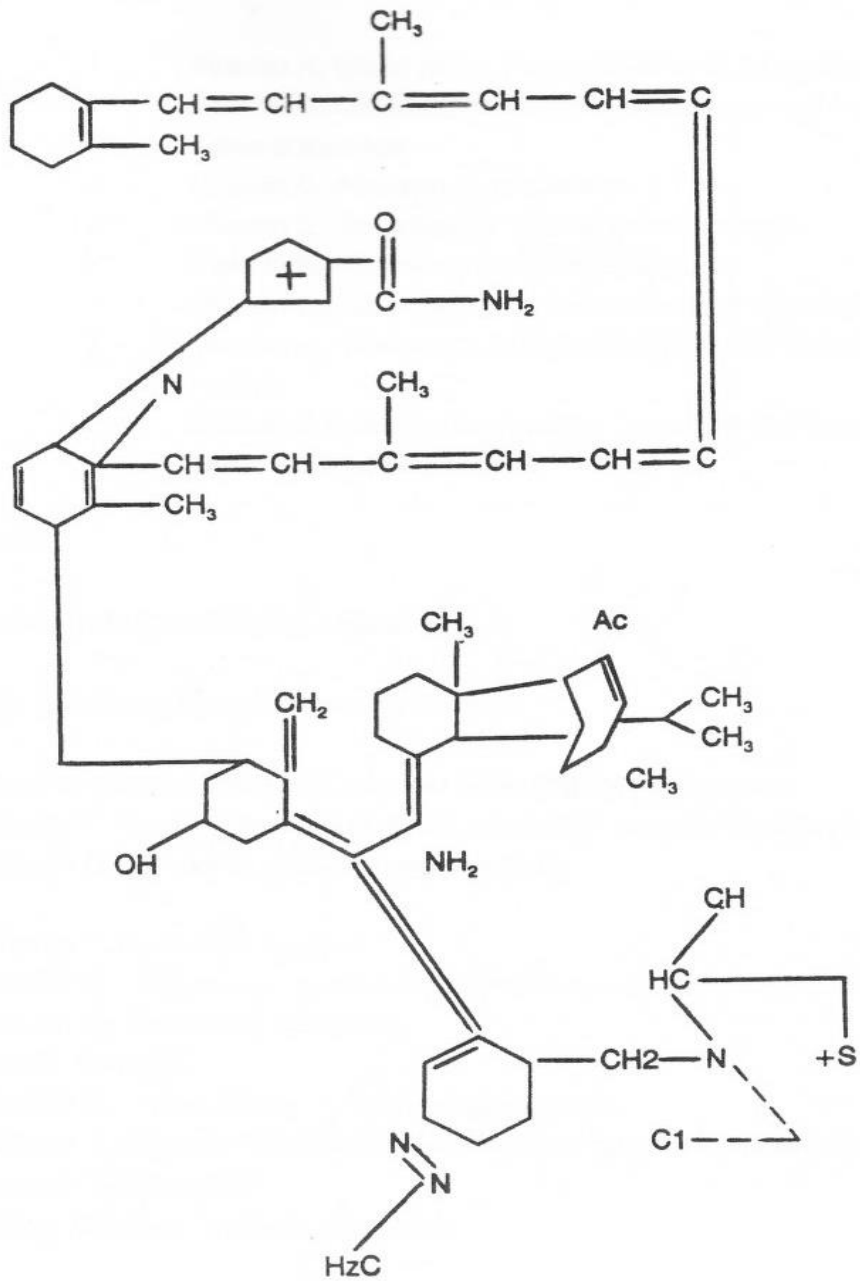

Chemical Composition

CLASSIFICATION: Nutrients and vitamins compound drug.

ACTION: See "Clinical Use"

CLINICAL

USE: Vitamin supplement each vitamin contained in stokaline, has a separate function:

- Vitamin A, visual pigments; maintenance of epithelial tissue.
- Vitamin C, Oxidation-reduction; maintenance of connective tissue adrenal function.
- Vitamin D, Absorption of calcium.
- Vitamin E, Essential for normal hematopoiesis.
- Vitamin B₁, Carbohydrate metabolism.
- Vitamin B₂, Coenzymes for metabolism of respiratory proteins.
- Vitamin B₆, Formation of Aminobutyric Acid; metabolism of Amino Acids.
- Vitamin B Complex and Niacin, component of coenzyme a biotin, to retain the ageing process.

USUAL

DOSAGE: 10cc.

POSSIBLE SIDE AND TOXIC EFFECTS - None.

NOTE: The vitamin deficiency symptoms are as follows:

- Vitamin A, Night blindness; corneal softening; hyperkeratosis.
- Vitamin C, Scurvy; swelling of gums; petechiae; anemia; capillary fragility.
- Vitamin D, Rickets in children; osteomalacia.

- Vitamin E, Hemolytic Anemia.
- Vitamin B₁, Central and autonomic nervous system disturbances; fatigue; neuritis.
- Vitamin B₂, Dermatitis, stomatitis.
- Niacin, Pellagra.
- Vitamin B₆, Convulsions; hyperirritability; edema.
- Vitamin B Complex, Neurologic disturbances; fatigue; irritability; dry, scaly skin; adrenal hypofunction.
- Biotin, Anorexia; Malaise; Dermatitis.

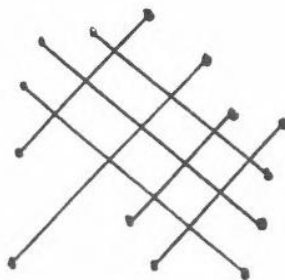

ALIEN PSYCHIC ABILITY

PSIONICS

Many cases of Psionic Power (the ability to mentally control surroundings, rearrange or create matter and/or project illusions) have been reported about alien skills.

The big difference between aliens and humans from Sol-111 is that the humans of Earth have the innate psionic ability and the big part of the Aliens (Greys, Nordics, and Oranges) is that they need a special psionic implant. Without this psionic implant, or in case of malfunction of the device, they have no psionic abilities.

Anyway we have to take care about our morals while using psionics because this power is a two-edged sword. The good that psionics can do must be weighed against the possibility of unleashing a dangerous megalomaniac.

Aura – The Aura, first detected by the Terran scientist Semyon D. Kirlian, U.S.S.R. during the 40's, is a Bio-Electro Magnetic Gravitational Field that surrounds every living creature, and a simple Electro Magnetic Gravitational Field for inorganic matter. It is the energy of this field that, depending on its intensity, can perform psionic phenomena.

Cosmic Rays – Cosmic Rays are streams of charged particles, protons, alpha particles, and a few heavier nuclei, which originate in outer space and can be intense enough to

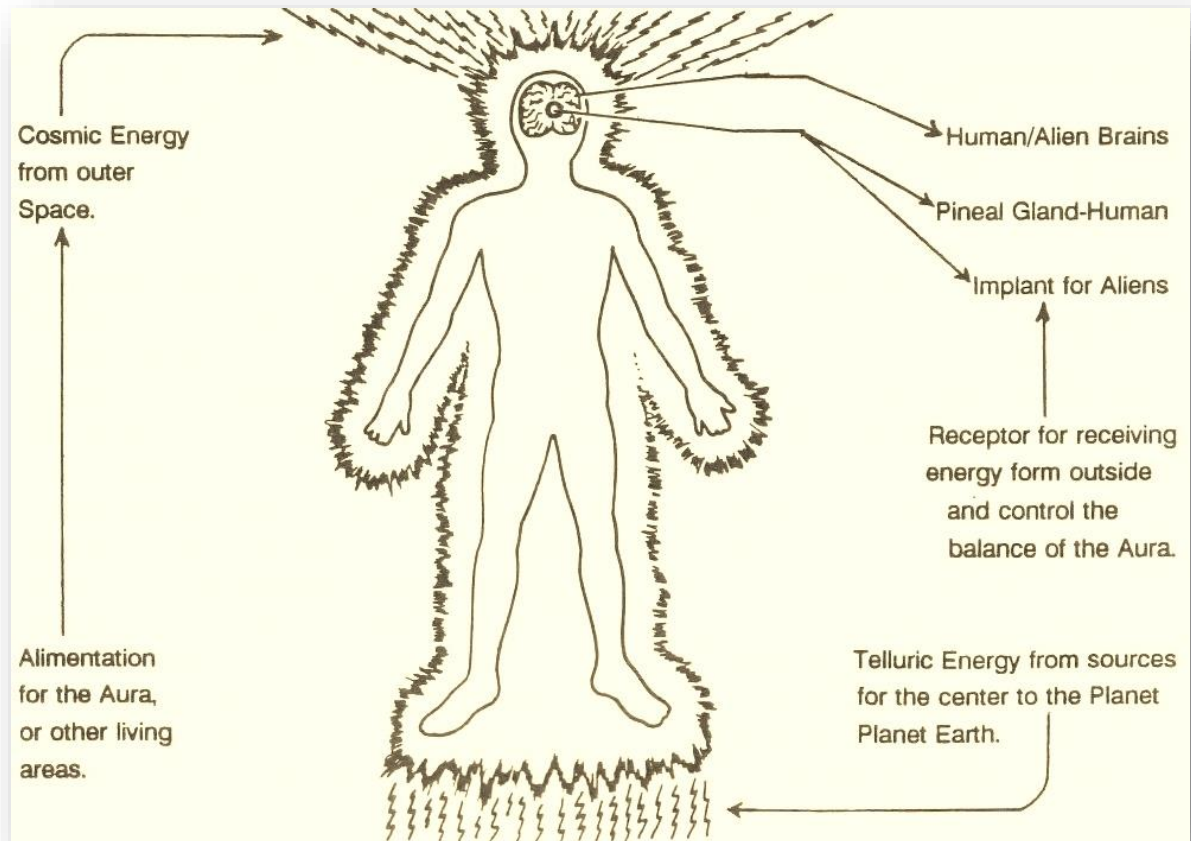

penetrate thousands of feet of rock. Cosmic Rays, present in a planet's atmosphere are secondary cosmic rays, the primary rays bombard the atmosphere from outer space and crash into the Nucleus of Atoms present in the upper atmosphere, producing mesons and a variety of secondary nuclear particles.

These in turn produce still more secondary cosmic particles. The intensity of cosmic rays can therefore be disproportionately high compared to the number of particles striking a planet. An average human can tolerate a radiation dose of about 0.01 roentgen per day without damage to his or her body. At extremely high altitudes or outside a planet atmosphere, the dosage can exceed the toleration point and protective armor is necessary. The extremely heavy nuclei of primary cosmic radiation, although very low intensity, may produce serious biological effects:

- 10% of mutations in secondary generation life forms are caused by radiation, of which cosmic radiation causes 25%
- Cosmic rays interact with the bio-antenna, (Pineal Gland) of the humans and produce Psionic activity.

Tewric Energy - Also electromagnetic gravitational wavelengths from the nucleus of the Planet Earth absorbed by the human aura can increase the energy of the aura.

Psychokinesis – Energy and matter can be influenced by the gravitational field of an individual, just the gravity of a star can interact with both energy and matter in its proximity; an altered state of consciousness, (usually involuntary) is necessary for this type of phenomenon. However, certain species and some human individuals can be trained to willfully alter their state of consciousness and thereby focus the power of their aura and utilize latent psionic abilities.

Plasma Reorganization – The process by which humans can command Psionic Power is conjectured to be similar to the matter, antimatter energy processes of an Aliens Starship engine. The energy is thought to be the direct result of an exchange between positive blackhole and negative whitehole, interacting to form intense energy patterns.

It has been further speculated that the human/alien mind, in conjunction with the adrenal and pituitary glands, (some aliens need to take this secretion from human fluids), can create the plasma reorganization necessary to produce a mental/matter interaction of subnuclear dimensions, some kind of “mental blackhole.” Creation of such a blackhole is always paralleled by that of an oppositely charged whitehole, and the two immediately begin to decay through Tachyonic Emissions. Such faster-than-light particle emissions are the medium through which psychokinetic and other psychoenergetic powers can be focused and applied.

It has been commonly accepted that any human being has the power to a lesser or greater degree to mentally control his or her environment using the focused energy of the aura. However, most humans believe more in the machine than in the human organism, and have forgotten how to truly use what they possess. This is apparent if we consider what could have happened if the Eastern Cultures had been dominant on Earth instead of the more technologically-based Western Society.

If humans had spent less time on the printing press and more on mind and body control, like the Buddhist Monks or Indian Fakirs for example, Earth today would be a very different place to live. There have also been cases where humans have been able to enlarge their Psionic abilities either through an increase in their aura power, or because of training by others who recognize and exploit these latent abilities.



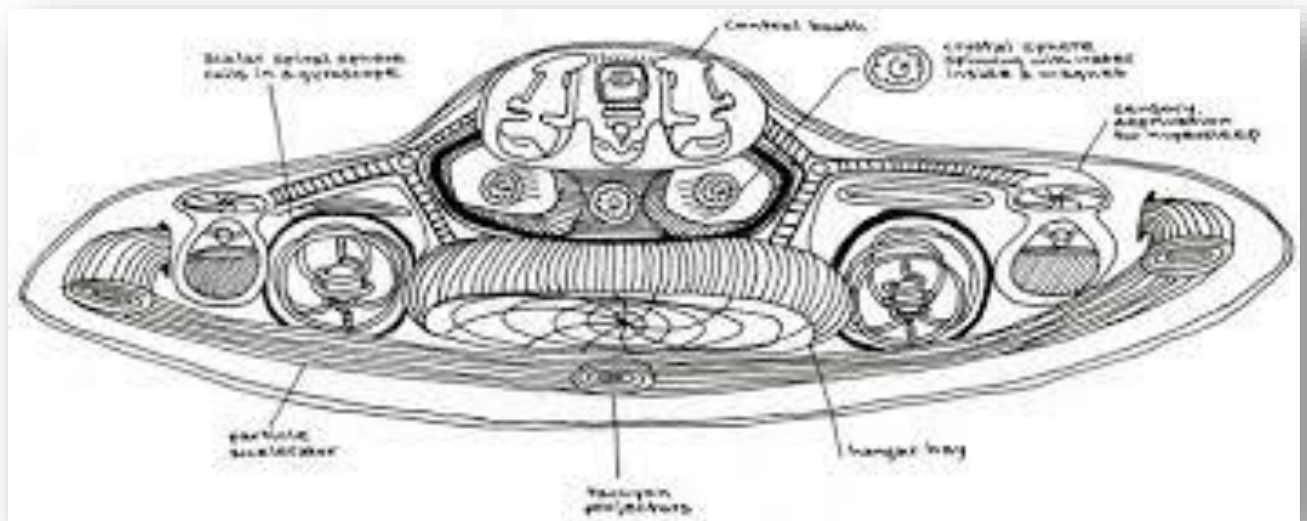

ALIEN CRAFT ENGINES

THE IMPULSE PROPULSION ENGINE – We don't have much data available at the moment (April 4, 1990), about the Warp Drive Operation of the basic Rigelian Starships but we do know that they work on the principle of Plasma-Energised Contained Antimatter. We get the secondary impulse engine system which serves for use at sublight speeds. This fusion reaction is located aft of the main saucer command section and can propel the craft at speeds up to that of 75% of the speed of light.

The impulse drive system works by channeling hot plasma energy exhaust away from the vessel. This plasma exhaust is not the by-product of simple plasma matter generated in a laboratory environment, but high-energy plasma produced in a fusion-reactor containment system.

Huge amounts of the plasma are first accelerated to high velocities along a ring of magnetic coils, and then injected into the space-time driver coils, the central component of the impulse engine system. These coils produce a limited distortion of the local space-time continuum, (not unlike that of local stasis field) and further accelerate the energy and speed of the impulse engine to near relativistic speeds of their escape.

THE SPEED GEAR DRIVE PROPULSION ENGINE – The main propulsion system of the most common "Mother Ships" is the FIF-2M, Multi-Field Speed Gear Drive. Under normal operation, the FIF-2M, Multi-Field Speed Gear Drive system can propel the cruiser at a speed of eight (8) speed gear, that is 8X8X8X8X8X the Earthian Speed of Light, with emergency speeds of speed gear nine (9) and beyond. At the heart of this massive drive system is the MAGNIUM Crystal assembly, which controls the matter/antimatter collisions.

They call "MAGNIUM" MMGNIUM or

Magnium is the only material yet discovered that can withstand exposure to antimatter particles for limited periods of time. Because of its unique crystalline structure, Magnium can hold antimatter suspended in the empty spaces between its atoms with only negligible annihilation of either Magnium or antimatter atoms.

If crystal is defective, its structure will permit too many antimatter atoms to touch the normal atoms, thus degrading the structure of the crystal itself at a measureable rate. This is known as Magnium decrystallization.

The Magnium crystal is housed in an armored cradle of MEGAPLASTIUM, (or in Alien Language, "MMGPLTUM". The hardest substance known to the civilized races. During normal operation, matter and antimatter are introduced into the Speed Gear engine core through separate plasma injectors. The Magnium crystal assembly is placed directly in the path of the two matter streams, which would otherwise collide with an explosive release of energy. Instead, particles of antimatter slip through the face of the Magnium crystal housed in the assembly block, the antimatter atoms splitting apart in reaction to the Magnium atoms then recombining in a very high-energy combination.

These newly combined atoms receive additional energy charges as they pass from one crystal to the next in the assembly. Naturally, a few atoms of Magnium and antimatter will collide on the crystal's surface, but a surrounding magnetic coil contains the energy and radiation from these collisions.

The streams of Magnium, energized antimatter coming from the Magnium crystal assembly now splits into separate plasma streams that are magnetically channeled along power transfer Nacelles, the modified antimatter streams, which results in mutual annihilation and the release of enormous energy. A by-product of the destruction of Magnium, energized atoms of antimatter is the release of unique electromagnetic properties that produce the Speed Gear Field surrounding the Mother Ship.

All Speed Gear Drive Systems fall into one of these types:

- Standard Speed Gear Drive units create a single Speed Gear field that surrounds the ship as it moves through space, allowing it to move at speeds in excess Earthian Speed of Light.
- Trans- Speed Gear Drive systems create a similar field, but improve on the original design by projecting portions of the Speed Gear field ahead of the ship. This creates a natural multiplier phenomenon, increasing speeds with only minimal increases on energy costs.
- Multi-Speed Gear Drive system. The so-called Mother Ships combine both the above systems to create multi- Speed Gear Field engine design. Though the Mother Ship is not a true Trans-Speed Gear Drive vessel because of its size, its Speed Gear system does have advantages over alternate Speed Gear Drives.

The Mother Ship Speed Gear Drive functions through a pair of separate Speed Gear units along each outboard engine housing. Each of these four (4) units projects its own Speed Gear Field ahead of the vessel as it moves through space. These fields overlap, which results in high speed Gear speeds for a vessel the size of a Mother ship, as well as, for almost instantaneous shifts from sublight speeds to Speed Gear speed.

It also makes possible near-instantaneous jumps to higher Speed Gear levels without the need for magnetic containment build-up time. In older generation Speed Gear Systems, the matter-antimatter intermix temperatures within the Speed Gear Engine units had to be carefully recalibrated to accept higher pressures before the vessel could move from one Speed Gear level to the next. The time needed to increase the strength of the surrounding magnetic containment fields could require from several Earth seconds up to several Earth minutes.

(Original claimed to be confiscated by NSA)

ALIEN SERVANTS OF THE GREYS

SERVENTS FROM RIGELIAN

SQH – They are a protosyntozoid, and have a low level of intelligence and therefore just follow orders. They are plus or minus three (3) feet tall.

OBS: No mouth, ears or nose.

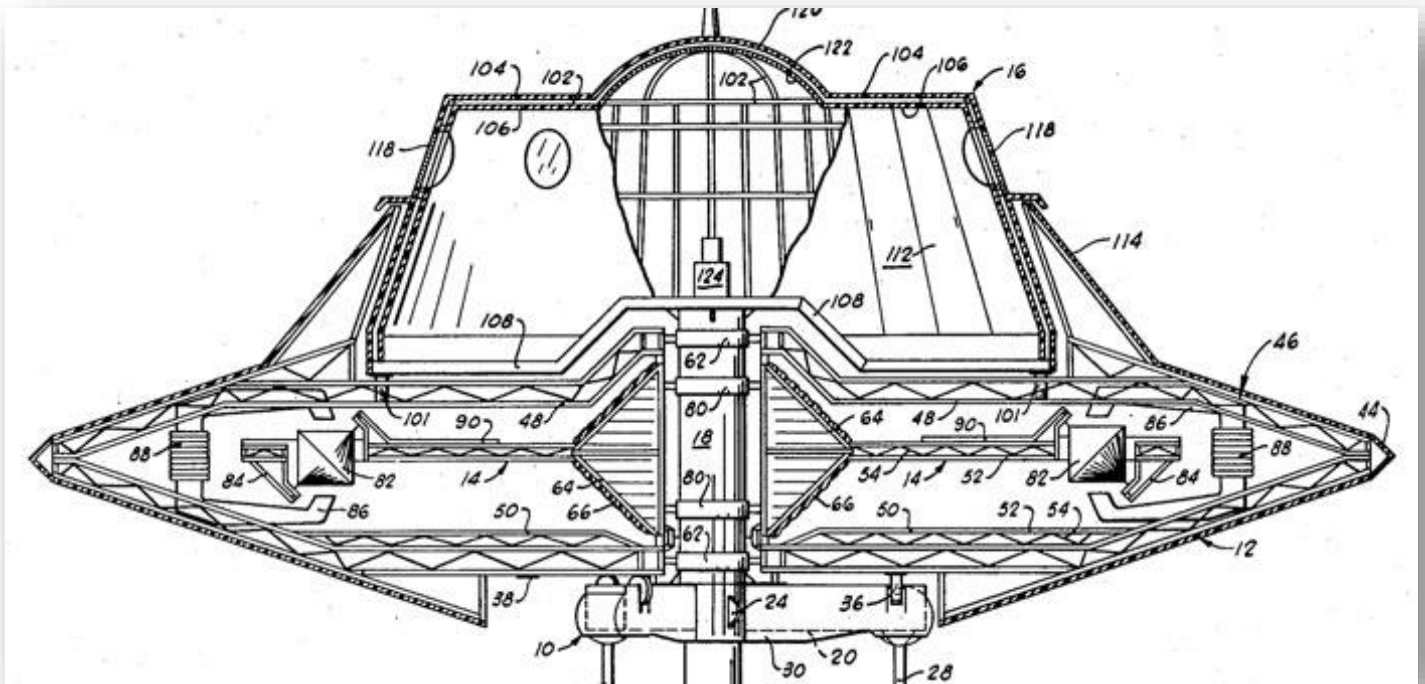

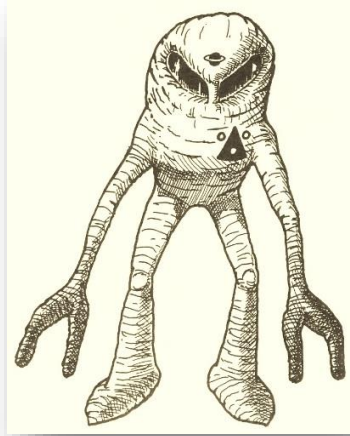

Tah'Hay – They are a mutative clone form, whose specific job is to complete research. They are plus or minus three (3) feet tall.

OBS: No mouth or nose.

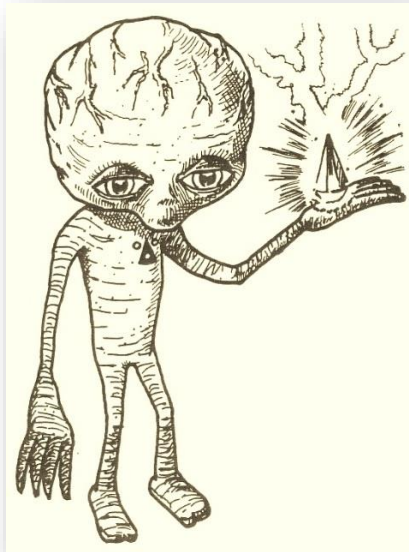

S'Pth – They are a cloned syntozoid form who's specific job is to act as controllers. They are plus or minus four (4) feet tall.



Replicas – They are a protosyntozoid clone form of humans, whose specific job is to be a special outside agent. complete research.

OBS: Face and body change shape at will.

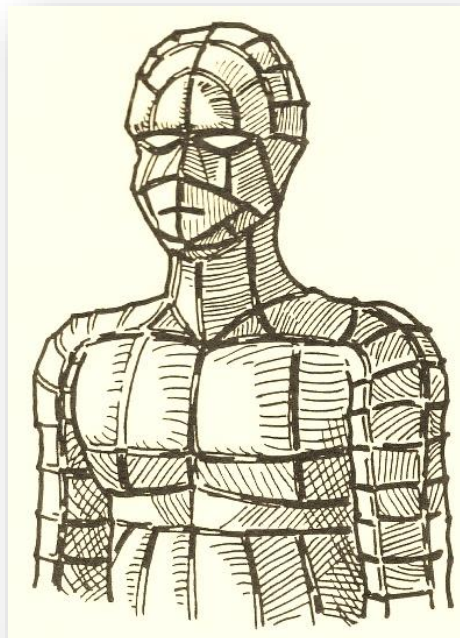

SERVENTS FROM Z-RETICULAE 1

P'TH - S'Pth – They are a cloned form who's specific job is to act as controllers. They are plus or minus four (4) feet tall.

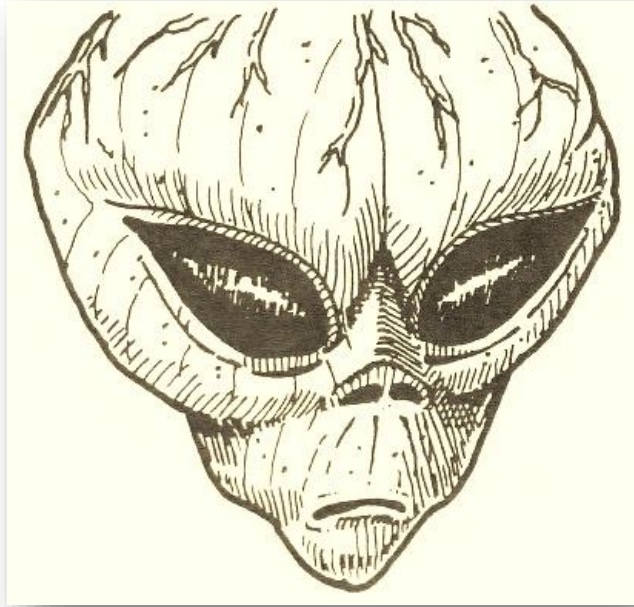

THROOB – They are originally from the Draco Constellation, whose job is to complete research. They are plus or minus four (4) feet tall.

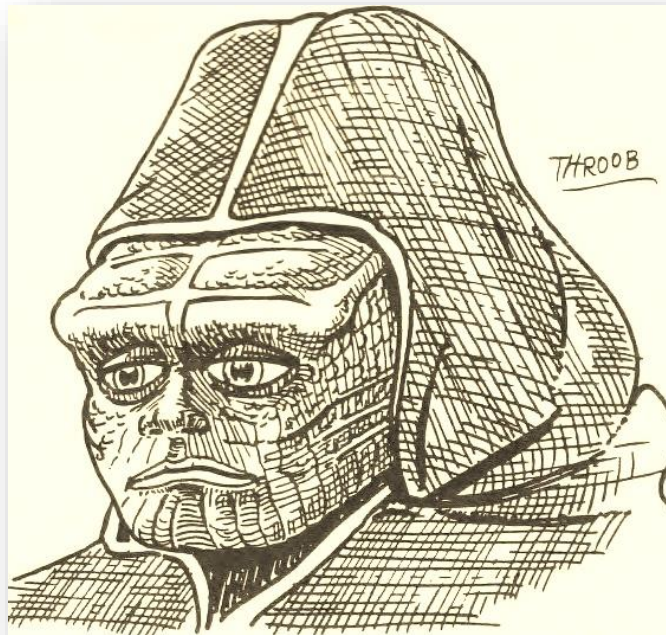

Thiaap'SH – They are a degenerative cloned form of the THROOB, and have a low level of intelligence. Their specific job is to act as workers, (as they are very strong). They are plus or minus four (4) feet tall.

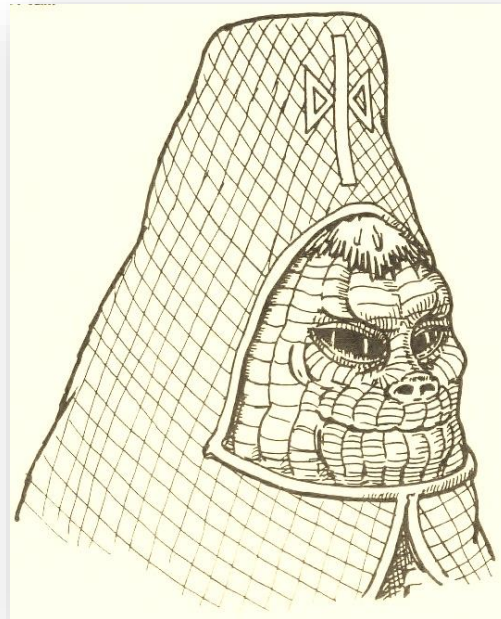

HZHZT'H They are a race of insectoids from Casiopea, whose specific job is genetic research.

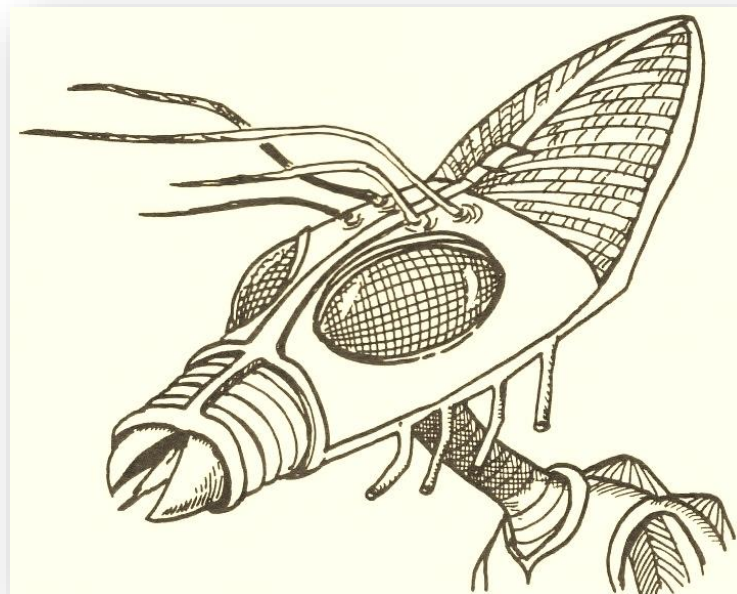

SERVENTS FROM Z-RETICULAE 2

The Z-Reticulae 2, 1st and 2nd type, normally don't deal with other life forms due to their position of servant. The only kind of life form of both races, is normally a servant called HBOOT.

HBOOT – They are a biological android with incredibly strong capacities.
OBS: The Nordics and Oranges normally use inorganic high tech servants.

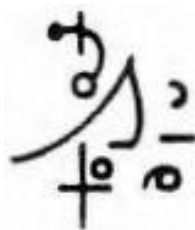
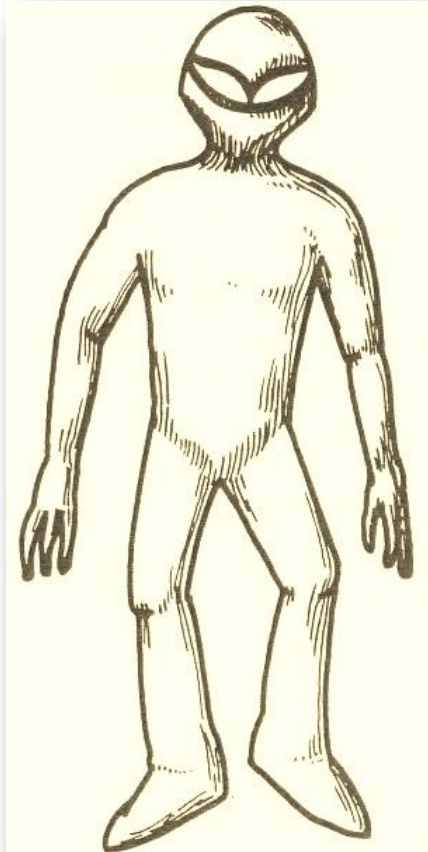



MK-ULTRA PROJECT

Talking about the Alien Affairs, we also have to talk about similar procedure affair made by the Government, "The Project MK-Ultra".

Just before starting to talk about this project, let's talk a little about what we have to know about UFOs, Aliens and the Government.

Several Alien races have been monitoring the human genetic process for millennia. Their presence on Earth has turned more intense, because during this last century, (1900's) we started genetic change, at first very slowly, and then very quickly. Their repositis were finally happening, but the technological psychic new human being was growing up very fast and out to control the Aliens. During World War 1, Germany discovered beings from outer space, with incredible high technology, were prowling around this planet.

Later in World War 11, the combination of both Japanese and German scientists discovered a high and low frequency pulsed sound. And when set at a specific, it affected an Alien craft. They knew this because in the late 30's Germany was testing a device for scanning the strange crafts in the sky and they would try to blast the Alien craft out of the sky, and they finally got one.

They recovered the craft and since that time to Hitler's takeover they tried to understand and use the incredible Alien high technology, to provide them with the ability to rule the planet. They tried to build a primitive transportation craft and even a powerful beam weapon, but the aliens didn't agree with the German philosophy to rule the world. The Aliens interceded before they lost their superior high-tech, and a fight broke out, which without the German's advantage of the high technology, was fought with conventional means.

In 1946, General Doolittle went to Scandinavia to investigate reports of "Ghost Rockets", which was the Scandinavian term for "Flying Saucers", (Alien Crafts), there were reports of hundreds and hundreds of sightings. Then in June 1947, the United States had the sightings up in Washington by Mr. Ken Arnold. The Government was quite worried about

it. Then the New Mexico incident happened and the direct action of the U.S. Government started to deal with the Extra-Terrestrial Biological Entities (EBEs). Creation of MJ-12 occurred, a government agency within the secret government, to work with, for, and against the Aliens. In reality MJ-12 is only for MJ-12, with MJ-12 and by MJ-12. About the other Alien species, (plus or minus 170 different species: human, humanoid and not human) they are either hostile, neutral or friends, but now let's talk about the MK-Ultra Project.

The MK-Ultra Project is an ongoing, and a notorious Central Intelligence Agency Project with the imperative focus of "Mind Control". Many abduction cases reported perhaps aren't alien interaction, it is indeed true that magnetic resonance scans of alleged UFO abductees show signs of intracerebral implants, and a host of UFO abduction researchers insist that the implants must result from Aliens dabbling in human affairs, but some implants are an Earthly technology, invented in the 1950's by Dr. Jose Delgado, (whose "Physical Control of the Mind" should be the very next book to be read by all abduction researchers.

Using these small devices, an experimenter can elicit changes in a subject's behavior through remote stimulation of the brain. Much of this work was continued on the MK-Ultra Sub-Project 95. Delgado went on to perfecting the techniques which allow the same results without the use of invasive procedures.

We should also note here that in the early 1970's, UCLA's Dr. Louis Jolyon West, a scientist closely associated with the MK-Ultra Project, wanted to open an institute for the Study of Violent Behavior on an abandoned Nike Missile Base in the Santa Monica Mountains near Los Angeles. This institute would have provided an ideally remote location for the practice of various mind control techniques, including Psychosurgery, Implantation, and also Hypno-Programmed operations.

Dealing with MJ-12's NRO security Operations, Project MK-Ultra as well served for the creation of disinformation, like alleged UFO abductees telling the truth, at least what they believe to be the truth, or the ability to program Alien witnesses to complete some mission, when they are interacting with Aliens. (Note: sometimes the Aliens intercepted the mission, and sometimes not. This seemed to be some kind of on Government Spying Techniques used on the Aliens). Also, the Government uses family and/or friends for this type of programmed surveillance of possible witnesses, Contactees and/or abductees to collect data. This means of data collection, (thanks to the MK-Ultra Project) confuses the issue. We have Alien Contactees/abductees and then we have our Government's contactees/abductees.

The Governments contactees/abductees are sometimes referred to as suicide spy squads, because the Government sees them as expendable.

We have Alien implants, (little devices that come in various sizes from 50 microns to 3 millimeters) and then Dr. Delgado's MK-Ultra implants. The motivation of all this perhaps is like as Sir Winston Churchill said:

"The truth is so precious it must be constantly protected by a bodyguard of lies"

The Controllers Affair – Besides the Alien abduction cases, we have also focused on the growing problem of the MK-Ultra activities.

We are talking about the infamous work of the “Implant-Spies from the U.S. Intelligence Community who have completed thousands, perhaps millions of cases where erasure of memory, hypnotic resistance to torture, truth serums, post-hypnotic suggestions, rapid induction of hypnosis, electronic stimulation of the brain, non-ionizing radiation, microwave induction of intracerebral voices, and a host of even more disturbing technologies which have been utilized.

We have already talked about some abduction implants and how, and who made them here on Earth.

Now we have to talk about another danger, “Remote Hypnosis”.

Remote Hypnosis – Hypnosis is not necessarily a person-to-person affair. The abductee, or the mind control victim, need not even have the physical contact with a hypnotist for hypnotic suggestion to take effect; trance could be induced, and suggestions made via the intracerebral transmitters: “Implants”.

Some clandestine researchers have mastered a technology called “RHIC-EDOM”. RHIC stands for “Radio Hypnotic Intracerebral Control”, and EDOM stands for “Electronic Dissolution of Memory”. Together these techniques can remotely induce hypnotic trance, deliver suggestions to the subject, and erase all memory for both the instruction period and the act which the subject is ordered to perform.

RHIC uses the stimoceiver, or a Spherical Biological Monitoring and Control Device, (SBMCD) and both are microminiaturized offspring of the technology to induce a hypnotic state. Interestingly, this technique is also reputed to involve the use of intramuscular implants. These implants are stimulated to induce a post-hypnotic suggestion. EDOM is nothing more than “Missing Time” itself, the erasure of memory from consciousness through the blockage of synaptic transmission in certain areas of the brain. By jamming the brain’s synapses through a surfeit of acetochole, neural transmission along selected pathways can be affected by an electromagnetic means, and can be effectively stilled. Modern research in the psycho-physiological effects of microwaves confirm the proposition.

The following is a list of Projects that used RHIC-EDOM technology:

- Artichoke Project
- Bluebird Project
- Pandora Project
- MK-Delta Project
- MK-Naomi Project
- MK-Action Project
- MK-Search Project
- MK-Ultra Project

Hypnosis was scarcely the only subject covered by MK-Ultra. Maji, NASA, and CIA scientists also thoroughly examined the areas of psychological conditioning, sensory deprivation, drugs, religious cults, microwaves, psycho-surgery, brain implants and ESP.



To: [REDACTED]
From: MK, Project MKULTRA
Date: 09/01/2006

RE: Introducing Project MKULTRA: The time for The Agency Of The Future is NOW
PROJECT OVERVIEW: THE CONTEMPORARY "BRANDSCAPE"

As you read this page, the landscape of entertainment and branding, the "brandscape", is changing in ways that we can only begin to comprehend. The unceasing pace of technological advancement is directly impacting how we currently, and in the future will, experience, create and consume entertainment. With the current acceleration and adoption of broadband, cable, VOIP, mobile, and P2P interaction, we are collectively connecting and exchanging information to an unprecedented degree. [REDACTED] This new reality is radically altering the social and behavioral sciences as we know them and mandating new business models and alternative branding strategies.

The core entertainment consuming demographic is young and adept in embracing new technology and ways of thinking, and reaching these earliest adoptors requires new insights and understanding. [REDACTED] As these consumers become more elusive and difficult to target in traditional ways - the industries collectively known as the entertainment business, including advertising - stand at a precipice, confronted with the reality that a new approach needs to be adopted to accommodate this radical and unstoppable change. [REDACTED]

New models need to be created, and new approaches need to be taken to address these new forms of distribution, consumer demands, consumption, and evolving standards for entertainment.

As technology, entertainment, and lifestyle brands search for new ways to reach their elusive core demographics, Project MK ULTRA is here to translate the semiotics of this branded new world.

ENTER

Sincerely,



Matthew Kramer

Director of Operations, Project MKULTRA LLC



What do we know about the NORDIC ALIENS?

Based on research, it is possible to come to several general conclusions concerning the Nordic Aliens:

- 1) There is warring among these beings, indicating they are not all unified. At the very minimum they are polarized into opposing sides, if not split into numerous independent factions. Some factions have a strong fascist orientation.
- 2) They walk among us pretending to be human. Some are integrated into society and hold strategic positions, whether to influence or simply observe.
- 3) They are genetically compatible with us, and some of their females have engaged human males for sexual encounters and even long term relationships. Through interbreeding their genes can enter our gene pool and vice versa. Therefore, some human individuals and bloodlines would have more of their DNA than others, and their alien DNA would likely show under analysis to be basically human, albeit rare and unusual.
- 4) Through genetic manipulation, they can insert alien DNA as a third party contributor to a developing human fetus, so that the child resembles both human parents while also being somewhat hybridized. Whether artificially hybridized, naturally conceived between human and alien, or fully alien, such a child born and raised in a human family will mostly pass for human, except they will be of a caliber beyond their peers. The greatest heroes of myth and ancient history were popularly viewed as cross-breeds between gods and men.
- 5) Throughout history, they have selected certain humans, or perhaps their own offspring / hybrids raised in human society, for privileged education, training, and guidance, so that these human proxies can function as vectors for their agenda, be it benevolent or hostile to mankind at large. This may include modern day contactees and abductees, ancient prophets and magicians, and the founders of mystery schools and secret societies like the Rosicrucians. Note that such secret societies are just larger, more powerful, institutionalized versions of individual contactees, that is, they are both under the guidance of aliens, given privileged knowledge, and charged with a mission fitting the agenda of their alien benefactors.
- 6) Considering that some of the esoteric knowledge communicated to humans is positively helpful, not all alien influences are selfish. It seems some are genuinely interested in raising humanity's potential in the areas of discernment, chivalry, ethics, and spiritual integrity.
- 7) They are all secretive and known to lie, even if only by omission, regardless of their spiritual orientation. Benevolent reasons may involve self-protection, observing a law of non-interference, complications with timeline dynamics, or the need to ensure that powerful knowledge is given to trustworthy people. Malevolent reasons could include the hiding of hostile agendas and hoarding of knowledge for leveraging purposes.
- 8) They are extremely telepathic. They can read thoughts with minute precision, implant thoughts, scan the soul for its level of integrity or weakness, induce hallucinations,

manipulate emotions, and steer a person's dreams. The human proxies they train can achieve these skills at a lower power level.

NORDIC PHYSIOLOGY

The Nordic species is of particular importance to this human-oriented reference work, not only because of its obvious similarities to the Terran norm, but because of its many differences as well. Although Nordics are humanoid-looking externally and almost identical to humans, (in itself a remarkable example of Hodgkin's Law of Parallel Evolutionary Development), we can view human physiology in its proper context by examining the subtly different and often highly specialized Nordic analogy.

Like most humanoid bipeds, the Nordics went through a long period where their precursor was not the dominant species on their planet. However, the most pressing problems for these pre-hominoid Nordics were not the flora or fauna of their planets, but the living conditions of that planet.

The Nordic planets are extremely hot and dry, with lower oxygen content and a somewhat higher gravity than Earth. Thus, the Nordics had to become adapted to these living conditions, not only to become dominant species, but for simple survival. This is not to suggest the Lamarckian explanation that form adapts to function, no Nordic planet's evolution followed Earth's standard Darwinian Theory. It is simply that conditions on Nordic planets were more uniform and harsh than those on Earth, so that Nordics are more specialized and homogenous than the Terrans.

On Earth there are diverse physical types, such as the Eskimos and Nilotics who fit Earth's more varied climatological conditions. The Eskimos have cold weather adaptations such as small nose and ears, and subcutaneous fat deposits. The Nilotic people, in contrast, possess physical adaptations for hot weather. The Nordics never developed separate physical or racial types because Nordic planet's climate and living conditions are more homogenous than Earth's. The comment that "Nordics all look alike to me" has some basis in fact. Just as all Eskimos share a great deal of physical similarities, so do all Nordics share a great deal of physical traits, such as:



THE NORDIC BODY

- **Eyes** (vision) – The Nordic eye is protected by a clear inner eyelid that filters out harmful radiation, heat and dust, all elements present on their planets. The eye itself is very similar to the human eye except for its range of color differentiation for high frequency waves involving the Ultra-Violet range is less acute, while night vision, involving low frequency waves in the infra-red range is more acute.
- **Ears** (auditory) – Like humans but with perceptions for Ultra and Sub Sound waves.
- **Nose** – The Nordic nose is very similar to the human nose, but not nearly as efficient as an instrument of smell. It is, however, highly adapted to filtering air and passing it on to the lungs. Since 60% of taste is in sense of smell, Nordics have a notorious lack of taste sensation. This however, does not hinder the Nordics enjoyment of food or lack of enjoyment as the Nordics are normally vegetarians.
- **Mouth Cavity** – The mouth cavity of a Nordic is almost identical to that of a human. The one essential difference is that Nordics have only (28) teeth, as they lack one pair of back molars.
- **Head and Skull** – The Nordics are an extremely dolicephalic, (longhead) people, not like the macrocephalic Greys. Their brain case is approximately 0.2cm thicker than that of a Terran and the bone itself is harder than the Terran skull. The male Nordic, however, does not possess the protective supraorbital Taurus, (bony ridges) above the eye like Terran males. \ often have.
- **Brain** – The Nordic brain is of the same overall structure and size, 1600cc, as that of the Terran. Only in the mid-brain area where telepathic and telekinetic powers originate is the Nordic brain significantly different. The Nordic mid-brain is somewhat larger and more convoluted than the Terran mid-brain, and this in part explains the Psionic Powers of the Nordics.

- **Overall Body Size and Shape** – Nordics, like Nilotics and Australian Aborigines, are a tall, slim people.

Males: Height 2 Meters
 Weight 90 Kilos

Females: Height 1.7 Meters
 Weight 70 Kilos

The arms and legs are long and slim with extremely lengthy and powerful muscles attached to a medium frame. The Nordics are high-waisted and short-bodied as a rule, and make excellent long distance runners. The size and shape of the Nordic postulates a convergent evolutionary trend with the Nilotic and the Aborigine of arid, hot and dry lands. Thus their body structure aids in the dispersion of heat through radiation. Concurrent with this is the lack of sweat glands in the Nordics, as he or she uses the blood, skin and body structure to keep him or herself cool, instead of the Terran way of heat loss through evaporation of perspiration.

- **Skin** – The Nordic epidermis, unlike human outer skin, is a two-way moisture-proof shield. Not only does it act as a water-proof barrier allowing cells to live in a fluid environment even in relatively dry air, as does human skin, it also allows available environmental moisture to be extracted for use by the body. In addition, highly specialized cells in the dermis, known as hyalothermonic cells permit more efficient body heat loss with retention of water than does human skin, because of an absence of sweat glands, necessary for Nordic life and explains the survival of the species in view of the environmental conditions of everyday life on the Nordic Planets.

NORDIC INTERNAL ORGANS

- **Heart and lungs** – The Nordic heart beats at the astounding rate of 242 beats per minute. The average blood pressure is 80 systolic and 40 diastolic. This phenomenon is explained in part by the extremely dilated blood vessels of Nordics. Also is an aid in cooling the body.

The Nordic heart is located where one would expect to find the Terran liver, leaving room for the somewhat larger Nordic lung assembly. In consequence, the cartilage that normally protects the Terran heart extends an extra 3.5cm downward in a Nordic in order to protect this vital organ.

Nordic blood is a copper based compound and is red-greenish in color. Copper-based life aids in the utilization of oxygen under the low atmospheric pressure, low oxygen condition on Nordic planets. Blood cells are Biconvex in contrast to the Concave cells of Terran's. This convex shape also aids in cooling individual blood cells, the entire bloodstream, and finally the entire Nordic body.

Another feature of the Nordic blood cell is its ability to take in and store large amounts of oxygen in a thin oxygen-poor atmosphere. A Nordic can survive for

hours underwater or in a non-breathable atmosphere due to his or her unique blood cells.

The Nordic lung is somewhat larger in size than its human counterpart, the alveoli in the Nordic lung is 75% more elastic and more efficient oxygen procurers than those in a human's lungs.

The Nordic heart is also somewhat large by Terran standards, but well within the normal range for humans. Its increased size relates to the increased work load of the heart. The only unusual or abnormal facet to the Nordic heart is its extreme muscularity. The heart walls are thinner, but stronger and more flexible than those of the Terran heart, allowing for a greater pulse range and a greater volume of blood to be moved around their body.

- **Kidney and Excretory Functions** – The kidney is a major part of the superior water retention system of the Nordics, again a necessary component of life on a hot, dry world. Whereas in humans, intake equals output, the Nordic excretes only 50% of the liquid matter that the kidney processes, the other 50% is purified by the kidneys and recycled throughout the body. Nordic urine is thus extremely rich in excreted minerals with a high specific gravity, and will kill plant life. It is also extremely thick and viscous, resembling in color and texture to freshly pumped crude oil.

Nordic feces are dry pellets with all moisture removed. Those familiar with Owl feces will quickly understand this concept, the Nordic digestive system completely removes all moisture and nutrients from food, leaving the excrement as a dry, extremely dense, compact mass.

- **Hormonal System** – The ductless glands of the Nordic are unlike those of the Terran, under self-control and not autonomous systems. The individual adult Nordic can regulate the amount of Adrenalin, (yes, the Nordics also have adrenalin, not like the humans, but it is adrenalin, which is produced without a pineal gland) and so it stepped up or slowed down by their internal systems in response to environmental conditions. The thyroid, (just like a human's) can also be controlled to change metabolism by stopping the flow of Thyroxin and Adrenalin, the Nordic can go into a state of suspended animation, very much like the trance state of the Indian Fakir of our planet. During this state of suspended animation, the Nordic can command bodily resources, i.e. blood, lymph, etc., to repair damage. Thus, the Nordic can control bodily functions that are considered autonomous by Terrans.
- **Reproduction** – The only gland system that the Nordics cannot completely control is that of reproduction. The female Nordic, like other human and humanoid females, are always capable of being impregnated by the male. The male, however, is only capable of sex approximately once in each year. This is a physiological condition. The Nordic females have a pregnancy period of (3) to (5) month incubation.

- **Nordic Cell Structure** – It contains a centralized nucleus and nucleolus, endoplasmic reticulum, (channels), mitochondria and ribosomes, “pretty similar to that of humans”.



ALIEN WRITING

EXAMPLES OF ALIEN WRITING – The following, in each respective written language, is a rough translation of “Keep your friends close, but your enemies closer!”

The Nordic and Pleiadian written language:

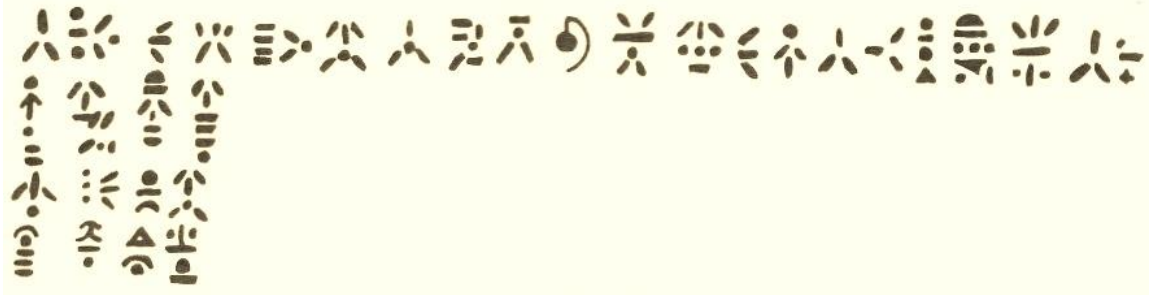

The Vegan Ancient Language:

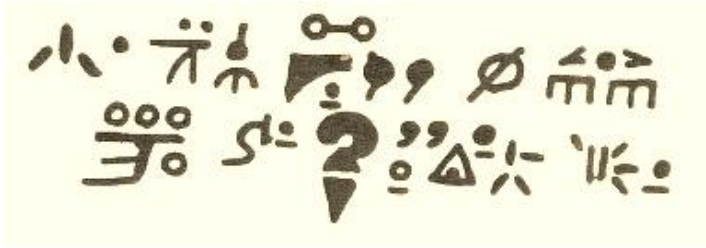

The Sirius written Language:



K'Thai and Orion written Language:

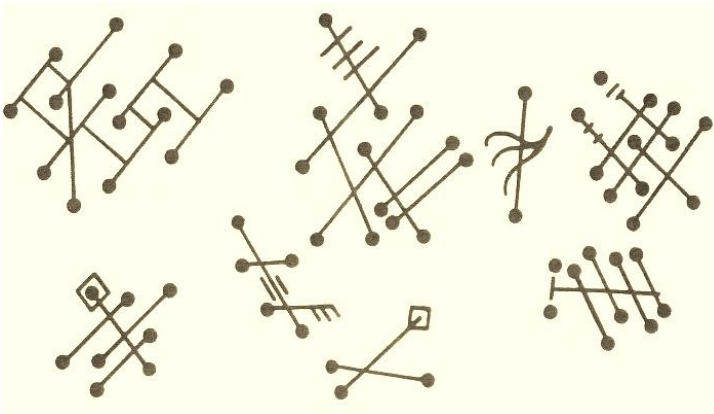

The Antatian Written Language:

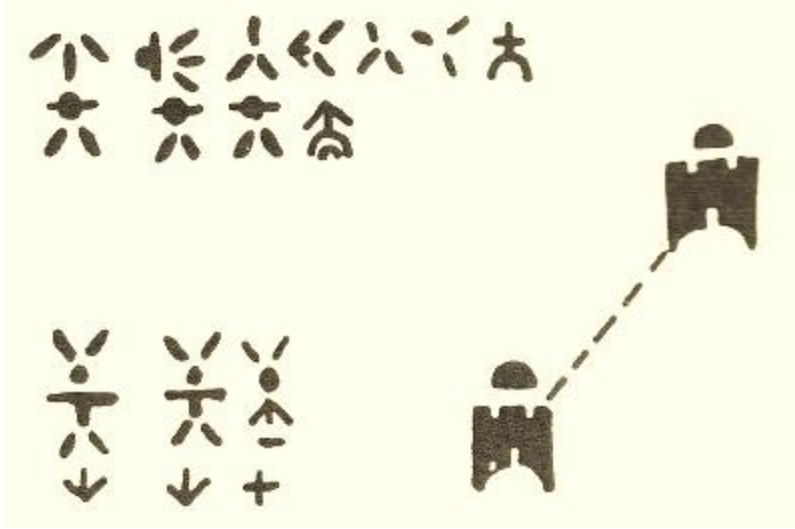

The Grey Universal Written Language:

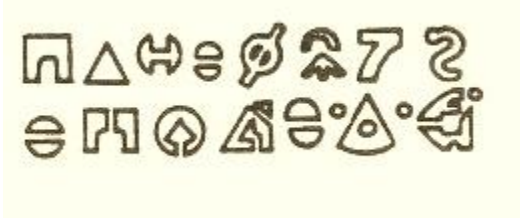

The Universal Communication Symbol Language:



VEGAN LANGUAGE

UNDERSTANDING THEIR WRITTEN LANGUAGE

This is a general guide to the basics of the Vegan language. It is not intended to be exhaustive but rather will provide the necessary basic communication skills needed in any unplanned contact with the Vegans.

ORTHOGRAPHY

<u>English</u>	<u>Vegan</u>	<u>Pronunciation</u>
CH	⊗	Ch as in <u>Ch</u> ange
SH	⊙	Sh as in <u>Sh</u> are
TH	⊕	Th as in <u>Th</u> at
A	⊔	a' ah has a double sound
E	⊓	e as in <u>e</u> at
I	⊗	i as in <u>i</u> ce
Y	⊓	y as in <u>y</u> et
W	⊗	
V	⊗	
F	⊔	
P	⊕	
S, C	⊖	as in <u>S</u> ent or <u>C</u> enter
L	⊔	
J	⊔	zh as in <u>V</u> ision
K, C, Q	⊓	as in <u>K</u> ick or <u>C</u> an

M	⌘	
N	⊠	
U	⊖	
O	⊗	
G (soft)	⚏	as in <u>G</u> entle or <u>J</u> ust
G (hard)	Ⓜ	as in <u>G</u> o or <u>G</u> et
D	⊙	
B	Ⓟ	
R	⊗	
T	Ⓐ	
H	Ⓜ	
QU	Ⓟ	

The Vegan language in addition to the standard alphabet, which is necessary to the production of word sounds, also contains a series of alphabetic sounds to describe Verb Tenses, and to make an object plural.

TENSES

	<u>Letter</u>	<u>Pronunciation</u>
Past Positive	H	a as in <u>A</u> ble
Past Negative	⊕	<u>A</u> te
Present Positive	(no addition to this tense)	
Present Negative	—	Oat
Future Positive	○	Aw as in <u>A</u> wful

Future Negative



Ot as in Otter

The letter is added to the end of the word, being described.

Example: The word.....	COLD =	𐌂𐌆𐌔𐌆
	was cold =	𐌂𐌆𐌔𐌆𐌆
	was not cold =	𐌂𐌆𐌔𐌆𐌆𐌆
	is cold =	𐌂𐌆𐌔𐌆
	is not cold =	𐌂𐌆𐌔𐌆𐌆
	will not be cold =	𐌂𐌆𐌔𐌆𐌆𐌆
	will be cold =	𐌂𐌆𐌔𐌆𐌆

The letter ~~X~~ is added before the word to make it plural. It is pronounced like the letter Z as in Zebra.

Example: The word.....	Book =	𐌆𐌆𐌔𐌆
	Books =	𐌂𐌆𐌆𐌆𐌔𐌆

Accentuation

In words of more than one syllable, the stress is always on the last syllable. The only exception to this rule is the plural, where the stress is on the ~~X~~: A glottal stop is always used between two identical letters, and example in English is the word Ski'ing.

Punctuation

- is a word separation. There are no spaces between the words, just the word separator.
- = indicates the end of a sentence or of a paragraph, like a period.
- + indicates an interrogative, like a question mark does in the English language.
- z are quotation marks, like in the English language. They enclose the words being quoted.

Sentence Structure

Basic Vegan sentence structure is as follows:

Subject—Object—Adjective—Verb

Instead of saying "I read an old book", the Vegan would structure the sentence as "I a book old read".

Capitalization

In the Vegan language, capitalization is used for proper names only, never at the start of a sentence, or for a title.

To capitalize a letter you add a line above the letter. In the Vegan language the sound of the capitalization letter is slightly changed. This is very difficult to hear and will take Earth years of practice to properly articulate.

Understanding Their Numbers

The Vegan number system is based on twelve (12) not ten (10) as is used in the English language.

<u>English</u>	<u>Vegan</u>	<u>Pronunciation</u>
0	X	Vet
1	/	tie
2	∕	til
3	≠	too
4	#	ta
5	S	Ko
6	Ⓢ	Kil
7	C	yo
8	Ⓢ	yil
9	I	pie
10	I	pil

11	○	way
12	∅	wen

Ones place holding is called tie and = 1
Tens place holding is called wen and = 12
Hundreds place holding is called toem and = 144
Thousands place holding is called beshu and = 1008

Care must be taken when translating numbers from the Vegan number system.

15 is not written literally as 15, (15) but is written as 13, (12 + 3).

0 is not used as a place order, base 10 expansion of the number 400 is written as follows:

$$4 \ 100 + 0 \times 10 + 0 \times 1$$

Base 12 expansion of the number 400 is as follows:

$$2 \ 144 + 9 \times 12 + 4 \times 1$$

If translated directly into English, it would read 294, not 400.

Understanding Their Time Measurement

The following time measurements are just general approximations and will give only a basic understanding of the nature of the Vegans time measurement practices.

The Vegan clock is based on divisions of 12 and is therefore similar to the time measurement used on Earth. There are some major differences however, in the length of each time segment.

The Vegan day is called *STEL* and it is equal to twenty two (22) Earth hours. It is divided into twelve (12) segments called *TARIM*.

Tarim roughly translated as an "Hour", and is equal to one hundred ten (110) minutes.

Each *Tarim* is divided in twelve (12) segments called *KEVN*, which we translate as "Period". It is equal to 9.17 of Earth's minutes.

Each *KEVN*, is further sub-divided into twelve (12) segments called *SURIEN*. We translate it into "Minutes" and is equal to 45.85 Earth seconds. Finally each *Surien* is sub-divided into 12 segments called *EWA*.

Each *EWA* is equal to 3.82 Earth seconds.

Vegan Written Language	Vegan Pronunciation _____	Earth Pronunciation _____	Earth Written <u>Equivilant</u>
▽▲□△	STEL	DAY	22 Earth Hours
▲#□×Σ	TARIM	HOUR	110 Earth Minutes
□□×□	KEVN	PERIOD	9.17 Earth Minutes
▽□□×□□	SURIEN	MINUTES	45.85 Earth Seconds
□×#	EWA	SECONDS	3.82 Earth Seconds

To name a given hour of the day, the word *TAR* is used.

Example: 6 O'clock is spoken KILTAR (KIL + TAR), or literally 6th hour.

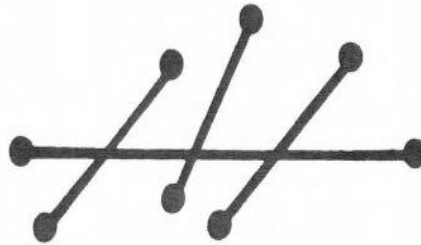

NAME	SYMBOL	ATOMIC WEIGHT	ATOMIC NUMBER	PLACE OF DISCOVERY AND DATE
DIBURNIUM	Db	(319)	122	ALIEN
DIKIRONIUM	Dk	(300)	112	ALIEN
DITLITHIUM	DEL	(315)	119	ALIEN
DYSPROSIUM	Dy	162.50	66	FRANCE/1886
EINSTENIUM	Es	(254)	99	U.S.A./1952
ELEMENT 106	-	(263)	106	U.S.A. RUSSIA/1974
ELEMENT 107	-	(280)	107	RUSSIA U.S.A./1977
ELEMENT 108	-	(288)	108	GERMANY U.S.A./1979
ELEMENT 109	-	(296)	109	INDIA U.S.A./1982
ELEMENT 110	-	(296)	110	INDIA/1983
ERBIUM	Er	167.26	68	SWEDEN/ 1843
EUROPIUM	Eu	151.96	63	FRANCE/ 1901
FERMIUM	Fm	(257)	100	U.S.A./1953
FLUORIDE	F	18.9984	9	FRANCE/1886
FRANCIUM	Fr	(223)	87	FRANCE/1939
GADOLINIUM	Gd	157.25	64	SWITZERLAND 1880
GALLIUM	Ga	69.72	31	FRANCE/1875
GERMANIUM	Ge	72.59	32	GERMANY/1886
GOLD	Au	196.967	79	KNOWN TO ANCI- ENTS ON EARTH
HALNIUM	Hf	178.49	72	DENMARK/1923
HAHNIIUM	Ha	(260)	105	U.S.A./1970
HELIUM	He	4.0026	2	SCOTLAND SWEDEN/1895
HOLMIUM	Ho	164.930	67	SWITZERLAND 1878
HYDROGEN	H	1.00797	1	ENGLAND/1766
INDIUM	In	114.82	49	GERMANY/1863
INDURITE	It	(322)	124	ALIEN
IODINE	I	126.9044	53	FRANCE/1811
IRIDIUM	Ir	192.2	77	ENGLAND/ FRANCE/1804
IRILIIUM	Im	(305)	116	ALIEN
IRON	Fe	55.847	26	KNOWN TO ANCI- ENTS ON EARTH
KIRONIDE	Ki	(348)	139	ALIEN
KRIPTON	Kr	83.80	36	ENGLAND/ 1898
KURCHATOVIIUM	Ku	(260)	104	RUSSIA/1964
LANTHANUM	La	138.91	57	SWEDEN/1839

NAME	SYMBOL	ATOMIC WEIGHT	ATOMIC NUMBER	PLACE OF DISCOVERY AND DATE
LAWRENCIUM	Lr	(256)	103	U.S.A./1961
LEAD	Pb	207.19	82	KNOWN TO ANCIENTS ON EARTH
LITHIUM	Li	6.939	3	SWEDEN/1817
LUTETIUM	Lu	174.97	71	FRANCE/1807
MAGNESIUM	Mg	24.312	12	ENGLAND/1808
MANGANESE	Mn	54.9380	25	SWEDEN/1774
MERCURY	Hg	200.59	80	KNOWN TO ANCIENTS ON EARTH
MOLYBDENUM	Mo	95.94	42	SWEDEN/1778
MURINITE	Mu	(320)	123	ALIEN
NEODYMIUM	Nd	144.24	60	AUSTRIA/1885
NEON	Ne	20.183	10	ENGLAND/1898
NEPTUNIUM	Np	(237)	93	U.S.A./1940
NICKEL	Ni	58.71	28	SWEDEN/1751
NIObIUM	Nb	92.906	41	ENGLAND/1801
NITROGEN	N	14.0067	7	SCOTLAND/1772
NOBELIUM	No	(255)	102	SWEDEN/1957
OSMIUM	Os	190.2	76	ENGLAND/1804
OXYGEN	O	15.9994	8	ENGLAND SWEDEN/1774
PALLADIUM	Pd	106.4	46	ENGLAND/1803
PERGIUM	Pe	(292)	111	ALIEN
PHOSPHORUS	P	30.9738	15	GERMANY/1669
PLATINUM	Pt	195.09	78	ITALY/1557
PLUTONIUM	Pu	(244)	94	U.S.A./1940
POLONIUM	Po	(210)	84	FRANCE/1898
POTASSIUM	K	39.102	19	ENGLAND/1807
PRASEODYMIUM	Pr	140.907	59	AUSTRIA/1885
PROMETHIUM	Pm	(145)	61	U.S.A./1945
PROTACTINIUM	Pa	(231)	91	GERMANY ENGLAND/1917
RADIUM	Ra	(226)	88	FRANCE/1898
RADON	Rn	(222)	86	GERMANY/1900
RHENIUM	Re	186.2	75	GERMANY/1925
RHODIUM	Rh	102.905	45	ENGLAND/1803
RODINIUM	Ro	(333)	125	ALIEN

NAME	SYMBOL	ATOMIC WEIGHT	ATOMIC NUMBER	PLACE OF DISCOVERY AND DATE
RUBIDIUM	Rb	85.47	37	GERMANY/1861
RUBIDIUM	Rd	(314)	120	ALIEN
RUTHENIUM	Ru	101.07	44	RUSSIA/1844
SAMARIUM	Sm	150.35	62	FRANCE/1879
SCANDIUM	Sc	44.956	21	SWEDEN/1849
SELENIUM	Se	78.96	34	SWEDEN/1817
SILICON	Si	28.086	14	SWEDEN/1823
SILVER	Ag	107.870	47	KNOWN TO ANCIENTS ON EARTH
SODIUM	Na	22.9898	11	ENGLAND/1804
STRONTIUM	Sr	87.62	38	SCOTLAND/1790
SULFUR	S	32.064	16	KNOWN TO ANCIENTS OF EARTH
TANTALUM	Ta	180.948	73	SWEDEN/1802
TECHNETIUM	Tc	(97)	43	ITALY/1937
TELLURIUM	Te	127.60	52	ROMANIA/1782
TERBIUM	Tb	158.924	65	SWEDEN/1843
THALLIUM	Tl	204.37	81	ENGLAND/1861
THORIUM	Th	232.038	90	SWEDEN/1828
THULIUM	Tm	168.934	69	SWEDEN/1879
TIN	Sn	118.69	50	KNOWN TO ANCIENTS OF EARTH
TITANIUM	Ti	47.90	22	ENGLAND/1791
TOPALINE	To	(306)	117	ALIEN
TRICOBALT	Tr	(332)	129	ALIEN
TRITANIUM	Tn	(323)	125	ALIEN
TRITITANIUM	Tt	(328)	128	ALIEN
TRIVIUM	Tv	(328)	127	ALIEN
TUNGSTEN	W	183.85	74	SPAIN/1783
URANIUM	U	238.03	92	GERMANY/1789
VANADIUM	V	50.942	23	SWEDEN/1830
XENON	Xe	131.30	54	ENGLAND/1898
YTTREBIUM	Yb	173.04	70	SWITZERLAND 1878
YTTRIUM	Y	88.905	39	FINLAND/1794
ZIENITE	Zi	(318)	118	ALIEN
ZINC	Zn	65.37	30	GERMANY/1746
ZIRCONIUM	Zr	91.22	40	GERMANY/1789

GREY REPRODUCTION SYSTEM UPDATE

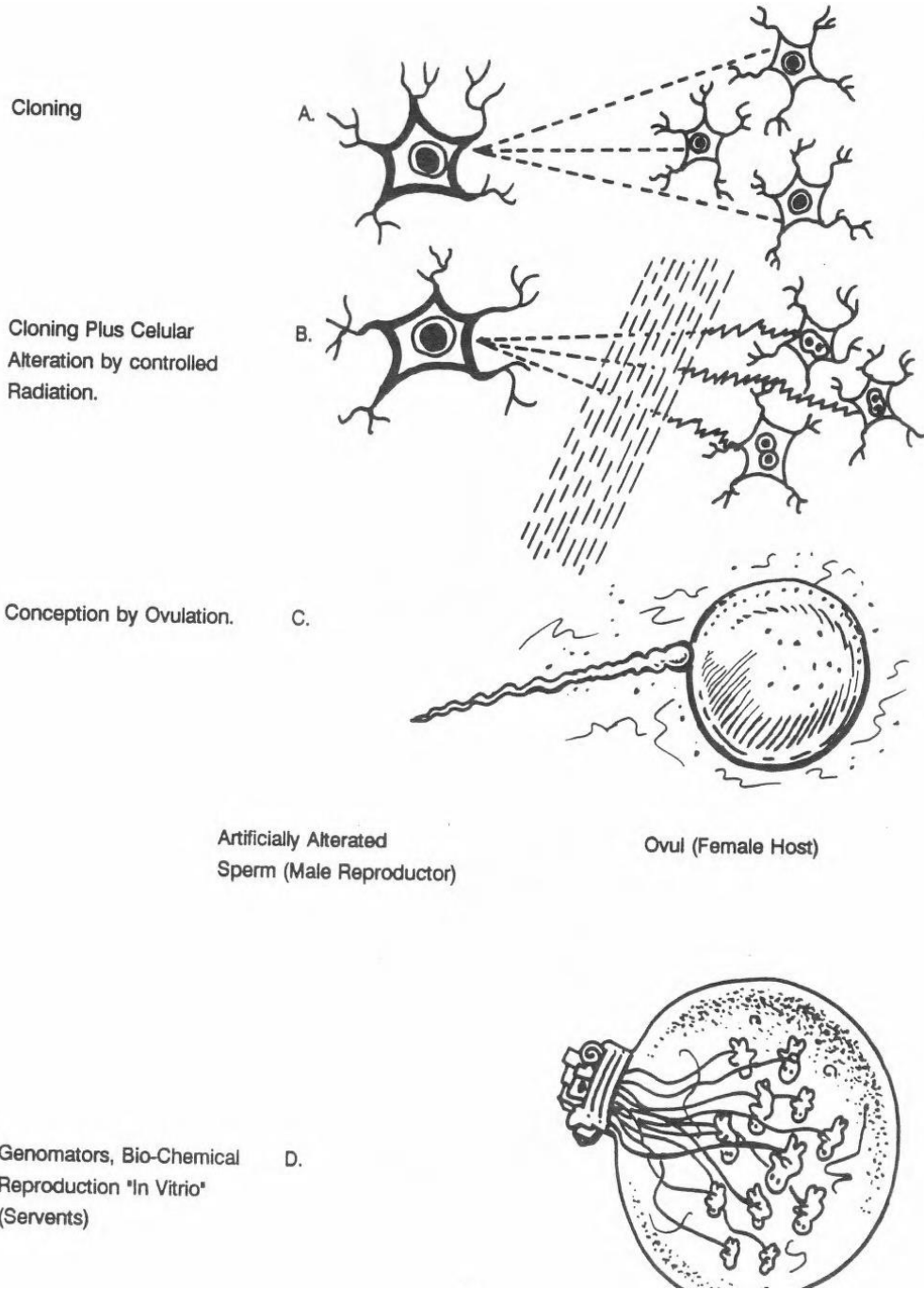

Bio-Plasmatic
or Bio-Ectoplasmatic
Transmaterialization

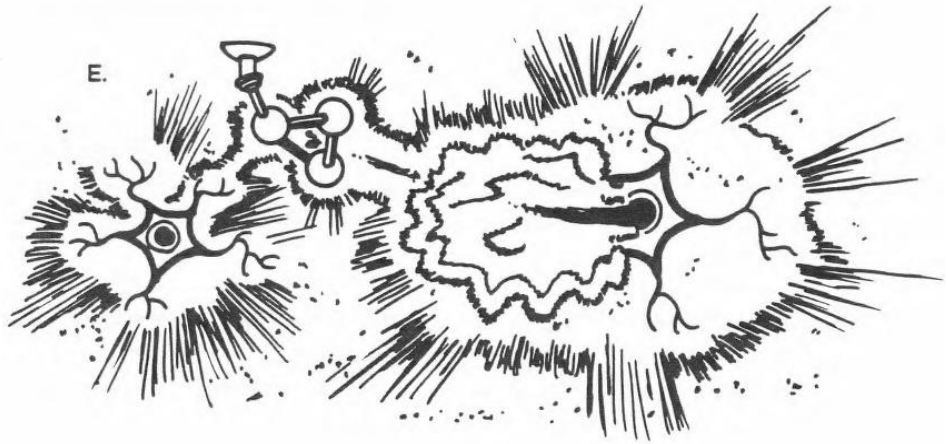

Eggs



Artificial Molecular
Displacement

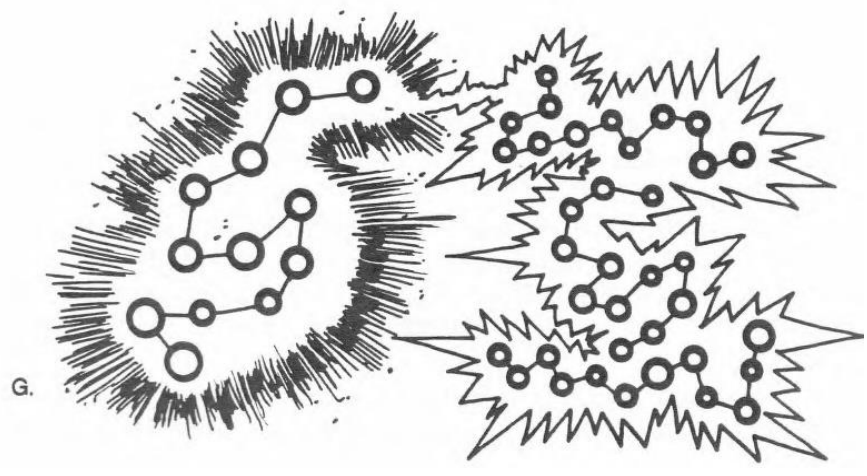

THE GOVERNMENTS PHILOSOPHY ON ALIENS

ARE THE ALIENS HOSTILE OR NOT !

Non-Hostility Situation I - Some Aliens show us some degree of positivity. Let's see how we can turn the unusual subjective reaction to abductions inside-out, from fear and paranoia to an attitude of cautious acceptance.

Misperceived Intentions - Our perception of an action must not be confused with the action motives of the beings performing the actions, since it is quite possible that frightening or negatively perceived actions are derived from genuinely good motives. Unfortunately, the UFO/ETI literature is filled with Conventional Wisdom that many aspects of the phenomenon represent sinister actions driven by equally sinister motives.

There is a facile tendency to conclude, either directly or by inference, that many reported actions are indicative of Malintent. A careful reading of many, if not most of the 1980's books about UFOs and Abductions reveal an alarming tendency to jump to sinister conclusions. Even the language used to describe these events are emotionally charged and shows a propensity towards assumed ETI hostility and malevolence.

An Analysis Is Needed - Reports of actions are taken as evidence of hostility or evil motives without a careful analysis of the possible neutral or positive motives which may account for the events.

As will be shown, such conclusions are both unwarranted and fraught with danger, since they color our thinking and emotions with unjustified fear, paranoia and negativity, and future popular ETI/Human relationships. We must be careful that our assumption of false hostility does not reate a future of actual hostility.

The reasons for reaching these negative conclusions are probably mutiple. Some events, on the face of them, appear disturbing to human sensibilities, lend themselves to quick assumptions of hostility. The entire topic of technologically advanced Extra-Terrestrials visiting Earth may play to innate human insecurities and fears of domination or loss of control. Also, the human tendency to think in linear and dualistic terms of Black or White, Good or Bad, etc. certainly contributes a psychological tendency to dwell on or be attracted to spectacularly negative thins or events, such as monsters, wars, murder stories, ghost stories and the like, may provide an impetus to reaching conclusions of ETI hostility, more people go to see a movie like "Friday the 13th", than, say, "Gandhi".

Unfortunately, sensationalized concepts of vile Aliens invading hopeless humans, sells books, movies and television programs. Let us take the most disturbing and sensational reports of ETI involvement with human reproductive events.

The Story of a female being taken aboard a craft and subjected to abdominal or vaginal needle probes to remove ova has been extensively studied in the past decade, i.e. the 80's, and while we do not definitely know everything, (*Note: About 96% are known at this time, the other 4% is not yet known*) let us assume that eh ETIs are taking Ova and Sperm and are preserving them, or are using them to develop test-tube babies, or even ETI human hybrids.

As disturbing as such events may sound, could there be Ultimate Intentions which are non-hostile ?

Protective Measures ? - What if the ETIs, alarmed by wild nuclear proliferation and/or massive ecosystem damage, perceive a high probability of a human or geological cataclysm in the near future? Could they be motivated by a desire to safeguard and preserve human and other Earth life in the event of a worse-case scenario ? If the hundreds of reports of ETI paranormal mental abilities are to be accepted, perhaps they have seen a probable future of massive Earth changes, and they view their own actions as a well-intentioned rescue attempt.

While ethical humans might be offended by this, perhaps the assertion that ETIs genetically intervened several hundred thousand years ago to establish modern homosapiens is true, and they are now attempting to further advance the human race.

While such concepts may shock and offend many humans, they are not motives of hostility or malevolence per se, especially from the ETIs perspective. Indeed, if ETIs view us as a race of beings whose chief activities are warfare, violence and environmental destruction, and who are on the verge of self-annihilation, such motives may be understood as benevolent and altruistic.

Possible Benevolence - The point here is that there are actually a number of explanations for even the most disturbing reports of ETI actions which involve non-hostile intentions. It is entirely possible, if not probable, that the ETIs actions which many humans view are hostile are actually neutral or benevolent, and would be seen as such even by humans if the "Big Picture" were appreciated.

What follows below is a brief listing of possible ETI motivations which are either neutral or positive:

Non-Hostile ETI Motivations, "Human-Perceived Positive and ETI preceived Positive"

- Protective Surveillance
- Emergency Intervention and Rescue from some future event, either a man made or natural type cataclysm.
- Human war limitation and control, i.e. Nuclear war.
- Documentation and preservation of ecosystems.
- Eventual ETI-Human knowledge and technology transfer, (pending world peace, and human non-agression.
- Eventual Earth incorporation into Inter-Planetary Union.
- Intercultural exchange and communication, long term plan.

Non-Hostile ETI Motivations, "Human-Perceived Neutral and ETI perceived Positive"

- Observation activities.
- Basic research activities.
- Sample and data collection activities.

Non-Hostile ETI Motivations, "Human-Perceived Variable, (may be positive, Neutral and/or Negative) and ETI perceived Positive"

- Limitation of Nuclear contamination of space.
- Limitation or containment of space exploration, pending human evolution to world peace, unity and non-aggression.
- Protection of non-Earth civilizations from human aggression.
- Human genetic research, preservation and experimentation:
 - A. To ensure continuance of the human species.
 - B. To develop advanced ETI Human hybrids.
 - C. Basic research activities.
- ETI security considerations, (i.e., safeguarding of ETI technology, protection of intelligence data base, etc., pending human evolution to non-violence).

On balance, UFO/ETI reports provide no overall evidence of total ETI hostility, (on Human terms). Some disturbing reports exist of course, but so do reports of peaceful intentions, kindness, healing, benevolence and so forth.

No conclusions regarding ETI intentions can be reached by simply viewing isolated case reports.

Polarizations Tendency - The polarizing tendency to declare ETIs as either sinister intruders or perfect god-like saviors is unwise at best, and probably dangerous to the long-term health of the ETI-Human relationship. This does not mean, however, that we must view this phenomenon in a motive vacuum, and I do feel that a strong case for assumed non-hostility can indeed be made. This assumption of non-hostility means that in our research, analysis and ETI interactions, we assume non-hostility until clearly proven otherwise. It does not mean that we regard ETs as necessarily god-like saviors, but this approach clearly avoids the premature characterization of ETI actions and motives as hostile or sinister. Such a moderate positivity and optimism is essential for the emerging ET-Human relationship to develop, (at popular basis, of course) with the least chance of conflict.

What they haven't done - Perhaps as much or more revealing about ETI intentions by what has not occurred as by what has. UFOs have not attacked humans or fired weaponry unless first threatened or attacked. ETIs have not invaded or destroyed any population areas, nor have they shown any intention to do so in the future. Notwithstanding superior technology and maneuverability, they have

not attempted any domination or direct aggressive actions over the past decades, (before the 90's, leading back centuries ago), of sightings. Such long term restraint belies any ultimately hostile intentions.

The assumption of hostility is illogical, when the entire phenomenon is viewed over time. If ETIs have been observing, and to some extent interacting with Earth for centuries, why delay a hostile occupation? The rather marked increase in UFO and ETI activities coinciding with the dawn of the human nuclear age in the mid 1940's would indicate a genuine concern about human hostile capabilities.

Long-term Survival - This would indicate that ETIs are:

- A. Concerned for the Long-term welfare and survival of humans, or;
- B. Concerned about the potential for human aggression being exported off the Earth to their Extra-Terrestrial civilizations, or both

Neither of these concerns are indicative of hostility towards humans, but rather a concern about human hostility. Certain militarists may find such interest in our nuclear capabilities disconcerting, but on balance this does not warrant a conclusion of ETI hostility. On the contrary, it supports the view that ETI motives are non-hostile in nature. ETI involvement and observation with humans is an ancient not recent, phenomenon.

If aggression, domination and such were actually motivating ETIs, why wait until the following:

- A. Humans possess weapons of mass destruction, capable of inflicting damage on even ETI crafts and personnel, or;
- B. Until the Earth has been significantly damaged and overrun by billions of humans ?

Certainly, the Earth would have been an easier and more pleasant catch just 200 years ago. On balance, the hostile Aliens theory, while sensational and making great science fiction reading, is illogical and is not supported by the facts of this phenomenon when analysed comprehensively.

A ROSWELL CRASH UPDATE



Long-Range Radar of this type is used by various NASA programs to track missiles and satellites. By use of feedback loops, this radar is able to follow a target automatically when "Locked ON"

This is the kind of experimental radar was in use by the military in some key Air Force Bases in New Mexico during 1947 especially during June, July, September and October of that year, leading up to and through the Roswell crash.



The above diagram, shows the types of radar displays that were available to the operators of the radar stations of this type of radar.

This type of radar is capable of producing specific results with catastrophic results to Alien Identified Craft, (AICs), because this caused a total malfunction in the propulsion system of some of the IACs. This specific craft works with geomagnetic propulsion.

Geomagnetic Propulsion - By having two electromagnetic current loops, the primary being around the diameter of the IAC and the secondary being perpendicular to the primary loop.

So both loops together provide hovering and stability to control the craft.

This was the main cause of the crash at Roswell. A collision with two (2) crafts caused by malfunction of the Geomagnetic Propulsion.

The following sequence is the Roswell crash representation. Two (2) AICs collided due to Geomagnetic malfunction, because of the military radar stations emissions:

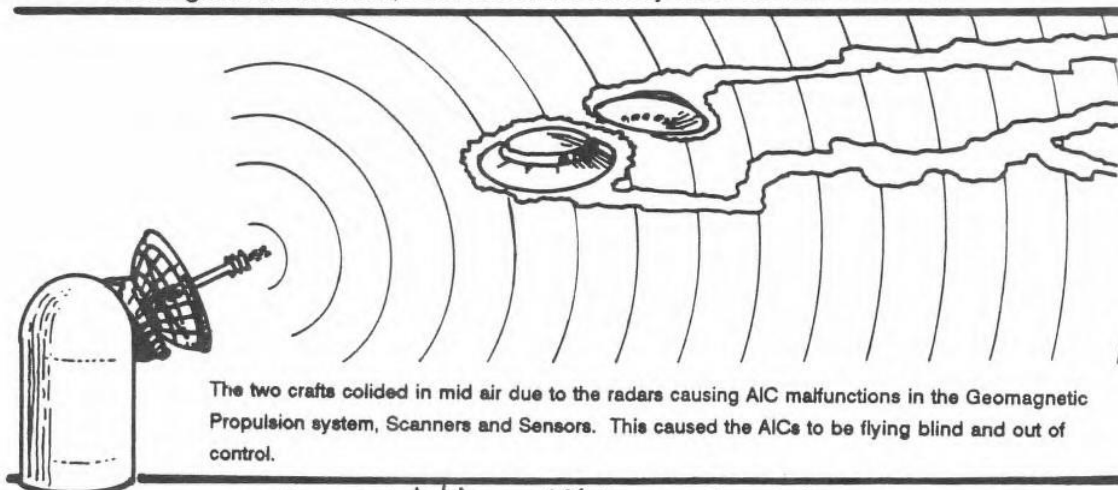

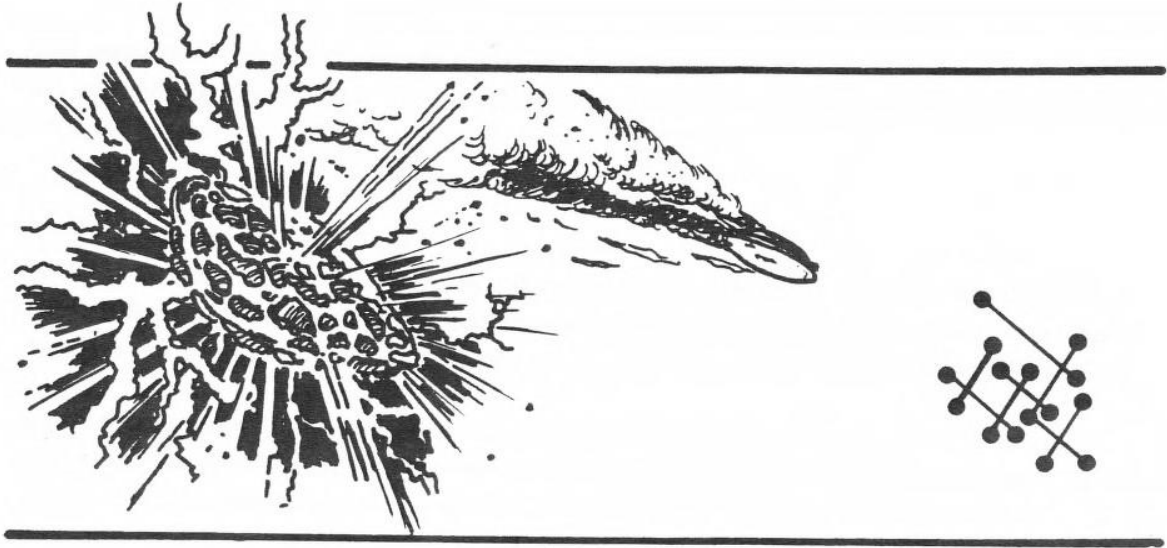

The one craft was disintegrated on impact with the other AIC. The other AIC was severely damaged and crashed a short time later.

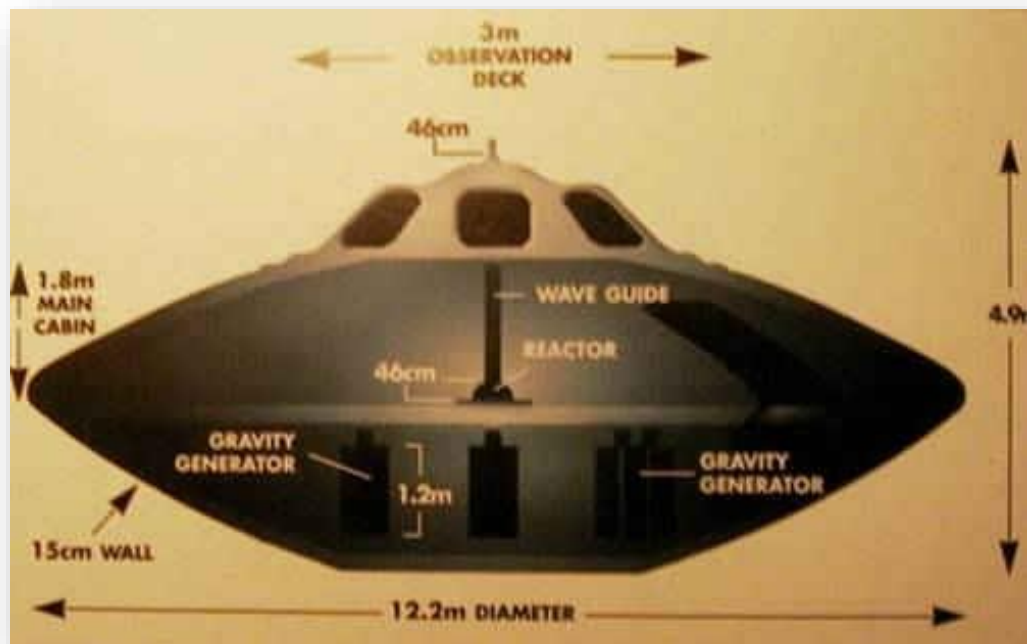

NATIONAL SECURITY AGENCY - SECURITY CODES

NSA maintains a variety of security codes for use during both peacetime and wartime. These codes are arranged by priority from 1 to 50. The function of these individual codes are summarized in the following pages.

NSA Security Codes NSC 1-29

NSC 1-10 codes are for normal peacetime transmissions of varying priorities, with routine transmissions between civilian and commercial centers and/or organizations, receiving priority dispatch of 1 through 5, and levels 6 through 10, used for priority NSA communications.

NSC 11-20 are used in conditions of hostilities between the Government, the Alliance and a foreign power. These priorities are used to transmit orders regarding the disposition of vessels and ground troops, the relocation of civilian personnel, the assigning of NSA resources to different commands, operation orders for these commands, and specific operation orders.

NSC 21-29 are for use by Government Diplomatic Corps.

NSA Security Codes NSC 30-50

These codes specify conditions of Emergency, with variable priority levels given to specific problems or crisis conditions during peacetime operations.

NSC 30 - Transmission of a communication of NSC 30 code, indicates an emergency condition involving a planetary disaster or other unspecified emergency. Use of this code level means that the sending station is not able to adequately respond to the emergency and requires immediate help at the scene.

NSC 31 - The NSC 31 code level is used for a medical emergency.

NSC 32 - The NSC 32 code indicates a planetary crisis of natural origin.

NSC 33 - The NSC 33 code level is used for a Bio-medical crisis requiring immediate evacuation of personnel.

NSC 34 - The NSC 34 code communication indicates a Bio-medical crisis requiring immediate quarantine.

NSC 35 - The NSC 35 code level signals an ecological disaster or similar planetary crisis.

NSC 36-38 - The NSC 36-38 code levels are used for crisis of unknown origin that require the immediate evacuation of a large segment of a region's populace.

NSC 39 - The NSC 39 code level indicates an attack by unknown agents on Government personnel or civilian installation with level A to D of security and/or intelligence.

NSC 40 - Transmissions coded NSC 40 level are directed to a specific Base or NSC Chief Science Officer, for disclosure to mission control or Base Command Staff only.

NSC 41 - NSC 41 code is similar to a NSC 40 transmission except that it is only for disclosure to the most Senior Officer present, or an authorized Special Agent.

NSC 42 - NSC 42 code transmissions are direct to a specific special mission ongoing or level A Base Chief Medical Officer, for disclosure to mission control's authorized personnel or Base Command Staff only.

NSC 43 - The NSC 43 code is similar to an NSC 42 transmission, except that it is disclosure to the most Senior Officer present.

NSC 44 - NSC 44 code transmissions are directed to a specific special mission ongoing or level A Base Security Chiefs, for disclosure to laboratory or Base Command Staff only.

NSC 45 - NSC 45 code, are messages similar to those using NSC 44, except that they maybe disclosed only to the most Senior Officer present.

NSC 46 - The NSC 46 code level is for direct messages to Government Flag Officers of the Rank of Captain and higher.

NSC 47 - The NSC 47 code level is used under circumstances similar to NSC 46, except that no acknowledgement or log entry of the transmission is recorded.

NSC 48 - Transmissions at the NSC 48 code level are solely for the Director of NSA, Commander of U.S. Defence, the President of the United States and the Commander of the Visitors Defence Force.

NSC 49 - The NSC 49 code transmissions are for members of the Majority Agency for Joint Intelligence, Level A-C or Alliance High Council, or their representatives.

NSC 50 - Transmissions coded at NSC 50 level are for the President of the United States or for the Alliance Supreme Commander or his designated representatives. No direct acknowledgement or record of these transmissions can be made without the President's prior authorization.

NSC ACCESS DATA LINE

Data Line: (202) 395-4972 9600 bps, eight data bits, no parity, one stop bit
(supposedly discontinued or changed on March 31, 1990.

CRM-28

57PRTK-PULSAR PROJECT

SRM2MANTIS/ABR26

Hot Line: (202) 395-3042 Password "Up and Down at the Blue Sky"
(supposedly discontinued or changed on May 9, 1990.

MN24DELTA7

The origin of UFOs may be the Earth!

Documents show that the government has long known that UFOs exist and belong to species more advanced than us. These species are not alien to our earth, only more advanced and they have lived here for millions of years, and are far ahead of us in development. (They probably consider us to be the aliens.)

The CIA stores data from tracking systems and deep-sea sonar, but even the scientists do not have access to this data about these aliens who have lived in the Earth's mantle, where conditions were more or less stable for millions of years.

These alien species seem to be able to live at different temperatures, they have been able to flourish and develop intelligence at an accelerated pace and they have evolved at a high rate. Because their living conditions in the Earth's mantle defended their civilization from the many disasters that have occurred on the surface of the earth.

The general consensus is that we're just ants from their point of view and there is a small chance that they will not continue to pay attention to us. But the military is considering the possibility of aggression and the current plan of action in emergencies includes a plan to detonate nuclear weapons in the deep caves to "seal" the enemy in the hope of destroying their communications, preventing further attacks from the bowels of the earth.

Alien Implants

Alien implants is a term used in Ufology to describe a physical object placed in someone's body after they have been abducted by aliens. Claimed abilities of the implants range from telepresence to mind control to biotelemetry (the latter akin to humans tagging wild animals for study). As with UFO subjects in general, the idea of "alien implants" has seen very little attention from mainstream scientists because of a lack of verifiable evidence.

History of Implant Claims

According to researcher Peter Rogerson (who is generally skeptical of alien abduction claims), the idea of allegedly genuine alien implants can be traced back to the 1950s, as part of the so-called "Shaver Mystery" -- claims that the "Dero", a sinister civilization beneath the earth, was kidnapping people for torture. Rogerson writes:

... The March 1957 edition of the Long John Nebel radio show featured John Robinson, a sidekick of Jim Moseley reporting a dramatically spooky, if not very plausible, abduction tale. The gist of it was that in 1944 Robinson had a neighbor named Steve Brodie who one day saw (in Robinson's apartment) a copy of one of Ray Palmer's magazines featuring the Dero. Brodie yelled out "He speaks of the Dero!", and proceeded to tell Robinson how he had been prospecting out west with a companion in 1938. One day they encountered two mysterious cowed figures who paralyzed Brodie by pointing a rod-like device at him. When the companion tried to flee, they fired at him and Brodie heard him scream, and smelled burnt flesh. When one of the figures placed 'small earphones' behind his ears he lost consciousness. From time to time he came to, in a place which fellow prisoners told him was the cave of the Dero. Each time his brain began to clear, the cowed one adjusted the earphones and he lost consciousness again.

He eventually came to, walking the streets of Manhattan two years later. Brodie showed Robinson scarred patches behind his ears, a little smaller than a silver dollar. Since his ordeal, Brodie claimed he was unable to eat meat ... Time passed; Robinson left the apartment but on returning for a visit found that Brodie had disappeared.

Another neighbor told Robinson that he had seen Brodie in Arizona, wandering about like a zombie. We are presumably supposed to conclude that he was back under the control of the Dero. It is in this unlikely tale that we first encounter the implants (behind the ears, as in *Invasion of the Martians*) and other abductionist staples such as the paralyzing rods and the doorway amnesia.

In later years, the claims of people like Budd Hopkins and David Michael Jacobs would popularize alien abduction ideas in general, including reports of unusual "implants" associated with abductions. Dr. John E. Mack, claims in his book Abduction that "I have myself studied a 1/2- to 3/4-inch thin, wiry object that was given to me by one of my clients, a twenty-four-year-old woman, after it came out of her nose following an abduction experience." An examination of the object revealed it consisted of a twisted fiber of carbon, silicon, oxygen and other trace elements, but no nitrogen.

Usage in Popular Culture

Alien implants have been featured in fictionalized treatments of the alien abduction scenario, such as in the popular 1990s television program The X-Files and an episode of the ABC comedy drama Castle.

Proof of Alien Abductions Found in Dust

A significant breakthrough in the search for trace physical evidence of alien abductions may have been uncovered in ordinary household dust. According to biophysicist Dr. William C. Levengood of Pinelandia Biophysics Laboratory of Michigan, microscopic "glassy particles" have been found in household dust of individuals claiming to be abductees. "Glassy particles" have been found in bedrooms, kitchens, family rooms, hallways, basement stairs, and so on. "Glassy particles" have not been found in dust where abductions are not known to occur.

The "glassy particles" come in a variety of shapes, including hollow or solid spheres. The particles are occasionally amber in color and vary in size from 1 micron or more, which is 1/1,000 of a millimeter. Other more elongated particles include the "pseudo crystal."

These forms are often clear and contain definite non-cellular, non-plant structure. A visual inspection of the "pseudo crystals" under 450x magnification gives the appearance of a fiber optic arrangement.

Household dust is best collected from areas not commonly dusted, such as the top ledges of doors and window frames. Unexplainable whitish dust in recently

cleaned rooms of abductees' homes has also tested positive for these glassy particles. While abductees' homes have produced two or more styles of particles, no abductee's home to date has produced all styles of particles.

Most Common Alien Groups

"Men came from the stars, knowing everything, and they examined the four corners of the sky and the Earth's round surface."

Greys

Roswell aliens, Zetas, and Reticulians, among other names -- allegedly appear in modern UFO conspiracy theories and other UFO-related paranormal phenomena. They make up approximately 75% of all aliens reported in the US, 20% of all aliens reported in Mainland Europe, and 12% of all aliens reported in Britain. In American popular culture they have replaced little green men as the most typical extraterrestrial life form experienced in abduction and in general seen in eye-witness accounts.

The Greys, or Grays, are part of humanity's history. In what capacity? The answers various with reports and conclusions by researchers and authors. Most currently their message is about humans as hybrids created through biogenetic experiments to create the next step in human evolution.

Reports from individuals who have been in contact with Greys vary. Some say they are kind beings who are here to guide us through our evolution, while others believe they are cruel invaders intent on ruling the planet. Greys allegedly crash-landed in Roswell, New Mexico in July 1947 eventually entering into an agreement with the U.S. government to provide them with advanced technology in exchange for human experimentation.

Reported Sightings

1890-1950

Although the exact appearance of the Grey has varied with time and media, the overall concept of "a thin diminutive grey figure with a bulbous bald head, large almond shape eyes, and minimal facial features", has existed in popular culture for over 100 years.

Grey-like beings have appeared in numerous science fiction stories from the late 19th century onwards; including H.G. Wells' *Of a Book Unwritten*, *The Man of the Year Million*; in which Wells writes about the hypothesis that the increasing industrialization of society would lead to humans developing into Grey like beings with shrunken bodies and enlarged brains, and his 1901 book *The First Men in the Moon* in which he describes the moon dwelling Selenites as being short, grey skinned creatures, with high foreheads, no nose, and bulging eyes who walked with a strange gait due to their oddly articulated legs.

The concept was continued in comics and science fiction magazines into the early 20th century, including such works as David H. Keller's *The Conquerors*, which was serialized in the *Wonder stories*, starting in 1929 December.

1950-1960

In the wake of the Kenneth Arnold sightings, the 1950s saw an increased public awareness of ETH and Flying saucer in America; leading to a corresponding increase in the appearance of Grey-like creatures in cinema and television.

1960-1970

Until the 1960s, the image of the Grey primarily existed in popular fiction, but this began to change in 1965 when the *Boston Traveler* published the purportedly true story of abductees Betty and Barney Hill. The story included details from a hypnosis session, conducted a year earlier by Dr. Benjamin Simon, in which the Hills described being taken aboard a pancake-like craft by small hairless men with no noses and slanted eyes that wrapped around to the sides of their heads.

Coincidentally on the 10th of February 1964; 12 days prior to the Hill's undergoing hypnosis, the science fiction series *The Outer Limits* ran an episode

entitled "The Bellerophon Shield", which featured a hairless, noseless alien with a bulbous head and 'wrap-around eyes'.

However, these similarities of greys to the TV episode being are disputed, mainly because the TV being is as tall as a human, does not have a very big head, his eyes are not that big, has no black eyes, and has a glowing body. Furthermore, Betty Hill maintained that she had not seen the Outer Limits, and said that it was unlikely that her husband had seen the episode, because he would either have been working, or performing community activities, during the series' time slot.

In 1968, Greys became associated with the Zeta Reticuli system, after amateur astronomer Marjorie Fish compared a Star Map drawn by Betty Hill to astronomical charts, and determined that the twelve stars depicted on the map showed the aliens home to be a planet in the Zeta Reticuli system, situated approximately 39 light years from Earth. This led to Greys sometimes being referred to as 'Zetas' or 'Reticulians' in popular culture.

1970-1980

In 1977, Director Steven Spielberg chose Greys as the alien protagonist for his film Close Encounters of the Third Kind. The Greys have since become the archetypal image of an alien for many UFO believers and science fiction fans.

1980-1990

During the early 1980s Greys were linked to the alleged crash landing of a flying saucer in Roswell New Mexico, in 1947, by a number of publications which contained statements from witnesses who claimed to have seen the US military handling a number of unusually proportioned, bald, child-sized corpses. The witnesses claimed that the corpses had over-sized heads and slanted eyes - but scant other facial features - during and after the incident.

In 1987 popular novelist Whitley Strieber published the book Communion, in which he describes a number of close encounters he purports to have experienced with Greys and other extraterrestrial beings. The book became a New York Times bestseller and inspired a number of sequels.

1990-Present Day

During the 1990s, popular culture began to increasingly link Greys to a number of Military-industrial complex/New World Order conspiracies.

Arguably, the most well-known of these was The X-Files, which first screened in **1993**. It combined the quest to find proof of the existence of Grey-like extraterrestrials with a number of UFO conspiracy theory subplots, in order to form its primary story arc. Other notable examples include Dark Skies; first broadcast in 1996, which expanded upon the MJ-12 conspiracy, and Stargate SG-1 which in the 1998 episode "Thor's Chariot" introduced the Asgard, a race of Greys who visited ancient Earth masquerading as characters from Norse Mythology.

The portrayal of Greys in the media took a slightly different turn in **1995** when film maker Ray Santilli claimed to have obtained 22 reels of 16mm film that depicted the autopsy of a real life Grey that was said to have been recovered from the site of the 1947 incident in Roswell, New Mexico. However, in 2006 Santilli announced that the film was not original, but was instead a Reconstruction created after the original film was found to have degraded. He maintained that a real Grey had been found and autopsied on camera in 1947, and that the footage released to the public contained a percentage of that original footage, but he was not able to say what that percentage was.

Perspectives

American researcher and alternative knowledge author Lloyd Pye advocates the hypothesis that modern Humans are the result of genetic intervention by Greys from another star system, and believes that there has been a sustained program to crossbreed Greys and Humans over the centuries. He holds that the Mexico Starchild skull constitutes empirical evidence in support of his standpoint.

According to English reproductive biologist Jack Cohen, the typical image of a Grey, given that it would have evolved on a world with different environmental and ecological conditions from Earth, is too physiologically similar to a human to be credible as a representation of an alien.

Neurologist Dr. Steven Novella believes that the physical appearance of a Grey does not represent a real flesh and blood creature, but that it is instead a byproduct of the human imagination. With the Grey's most distinctive features representing everything that modern humans traditionally link with intelligence. The aliens, however, do not just appear as humans, they appear like humans with those traits we psychologically associate with intelligence.

Novella holds that if you were to plot the physical differences between an ape and a human, and then were then to apply these differences directly to a human model, the resulting human would strongly resemble a Grey.

Philosopher Michael Grosso believes that Greys, along with many paranormal myths and legends throughout history, are the telepathic manifestation of the collective consciousness of a community or culture. He proposes that the physical form of the Grey is that of a malnourished human being, not an alien, and that Greys may be a manifestation of guilt felt by the developed world over the plight of the developing world.

Alternative Perspectives

While Greys are commonly cast as being factual/fictional extraterrestrials, a number of alternative perspectives also exist. Including that Grey-like beings are:

A modern iteration of ancient folklore and myth

Part of a government-led disinformation/plausible dependability campaign

A future evolution of the human race, or an alien race from the future, that has traveled back in time

Extradimensional life forms

A product of Government mind control experiments

Description		
Extra-terrestrial Species:	Greys	
Aliases:	The Visitors	The Reticulians
Height:	3.5, 6 feet	
Weight:	65, 90 pounds (estimated)	
Eyes:	Large, oval-shaped, black	
Hair:	None	
Skin:	Grey	Rough-textured
Sex:	No visual reproductive organs Cloning suspected form of reproduction	
Communication:	Telepathic	
Location of Origin		
Zeti Reticula Star System in the Orion Constellation		
Distinguishing Characteristics		
Slit for mouth		
Nose and ears are indentation		
Webbed hands with four fingers		
Thin body		
Large head in proportion to body		

Typically, Greys are described as being approximately 4 feet tall, with grey (sometimes blue-grey/green-grey) skin. Their body is typically described as being elongated, and lacking in muscular definition. Their legs are shorter and jointed differently than one would expect in a human, giving them an apparently awkward gait. Their arms often reach down to their knees, and some accounts give them three digits, or three digits and a thumb on each hand. They have a bulbous, hairless head supported by a thin neck, which is dominated by large black lidless eyes. They typically have small flat noses, small mouths and small ears lacking a pinna. In some cases, Greys are said to have slit-like nostrils on a flat face. Some accounts have Greys wearing tight neutral colored uniform-like jumpsuits or have no attire. In most cases, Greys have no determinable gender and no visible external genitals.

Alleged Sub-Types

Type A

This is the type most commonly referred to as the greys. Also, known as Zeta Reticuli from the Zeta Reticuli star system (the Bernard star) neighboring the Orion area. They function in a mode that is apparently military in nature with a rigidly defined social structure that holds science and "conquering worlds" to be the prime movers. They are normally about 4.5 ft tall with large heads and black "wrap around" eyes. They have limited facial features, slit mouth and no nose to speak of. They have evolved beyond the need for reproductive systems or digestive systems and reproduce by cloning. Their genetics are partly based on insectoidal genetics.

Their science deals largely with the study of other life forms and genetic engineering. They have allegedly had a part to play in the alteration of human genetics over thousands of years. It seems that they may be trying to cross breed with humans in order to create a "mixture race" that would be better than either. (I've read that they are a dying species that have cloned so much that now, with each successive cloning, the species grows weaker. They are trying to infuse new life into their species by creating the mixed breed.)

There seem to be two main social classes. One is the more hawkish and is more abrupt, crude and blunt. The more dove-like ones are more refined and capable of a more business-like behavior towards humans, and prefer to use more "diplomatic" behavior to gain control over humans. This type of Grey is what I believe is being referred to as the "Orange" class of Greys.

They seem to be emotionless (by human standards) and therefore are seen as cruel in their treatment of human beings. They are able to take human lives without any regard for that individual. They allegedly can use certain substances of the human body for their sustenance and therefore appear to be carnivorous in regards to humans.

These Greys are described as servants to a master race of reptilian-type aliens and are trying to prepare the earth for their arrival by gaining control over the Earth through many means. They tend to enjoy the feeling of freedom they have on Earth, away from their masters and would desire the help of humans

in confrontations with the reptilians, which appears to be a consideration for the near future.

These are the Greys that we associate with bases in New Mexico and Nevada but are also known to have bases in many countries of the world.

Type B

These are the Tall Greys from Orion. Usually about 7 to 8 ft. tall (reports often exaggerate their height as being 9 to 12 ft.) with facial feature somewhat similar to grey type A with the exception of the large nose found on type B greys. These greys allegedly have technologies that allow them to perform certain actions that appear "miraculous." They are less vicious towards humans than type A greys (but are still considered "hostile".) They tend to influence more through political controls and negotiated agreements with those in power. Their main bases seem to be in the Aleutian Islands.

Type C

These are the shortest of the greys and tend to be about 3.5 ft. tall. Their facial features are very similar to the Zeta Reticuli greys and are of the same "root race." They are just as hostile to humans as the Zetas. They are from a star system near the shoulder of Orion called Bellatrix.

Nordic Aliens

Nordic aliens are one of several types of extraterrestrials featured in the UFO mythos. Nordic aliens are said by contactees and some UFOlogists to be a group of humanoid extraterrestrials who resemble European racial images, or more specifically Nordic-Scandinavians.

Description

Nordics are typically described as six to seven feet tall with long blond hair and blue eyes, and are commonly reported as being male. Their skin is said to range from fair colored to tanned, and they are sometimes reported to wear skintight clothing.

Nordic contacts, often from Venus, were frequently reported in the 1950s and 1960s, but declined after that. Purported contactees claim to have witnessed the Nordics beaming down from gold or silver colored crescent-shaped UFOs or from gigantic bright cigar-shaped UFOs.

Reported Demeanor

Nordic aliens have been described as benevolent or even "magical" beings who want to observe and communicate with humans. Contactees have said that the Nordics are concerned about the earth's environment or prospects for world peace, and may transmit messages telepathically.

The the typical Nordic is paternal, watchful, smiling, affectionate, youthful, and all-knowing. And the Nordics are often associated with spiritual growth and love and act as protectors for the experiencers.

It has been claimed that the Nordics have warned contactees about the grey aliens, but other claimants say that they have seen Nordics inside the same craft as greys. In such reports, the Nordics are often interpreted as leaders, with the greys as their subordinates. It might accurately be described as while Nordics have been involved in abductions, the actual abduction is less essential to the encounter than it is with the greys.

Claims Throughout History

The term "Nordic" did not come into wide use until the 1980s. In earlier decades, the entities now described as Nordics were often called "Space Brothers". Some of the best known individuals who claimed to interact with Space Brothers include George Adamski, Howard Menger, and Billy Meier (who said his contacts came from the Pleiades system). However, some claim that these men's stories are absurd hoaxes.

There are rumors that President Eisenhower met with Nordic aliens at Edwards Air Force Base in February 1954 in an attempt to formulate an agreement over technology exchange and the elimination of the American nuclear arsenal. Although, of course, such claims are flatly dismissed by archivists at the Eisenhower Presidential Center, who have fielded many questions on the subject over the years.

Analysis

Early stories of Nordic-type aliens may have been partially inspired by the 1951 film *The Day the Earth Stood Still*, in which extraterrestrials arrive on Earth to warn humanity about the dangers of atomic power.

Some have observed that "white extraterrestrials are those that are most revered", compared to other beings like the greys.

Reptilians

Metaphysical Myths Based on Metaphors

The Reptilians are the creation of the Carians, (Bird Headed Beings) their parent race. They evolved on a planet in the Alpha Draconi star system of the Orion Constellation. The royal line of Reptilians are the Draconians, or Winged Dragons from the House of El. Reptiles have two major sub races, Winged Serpents (Snakes) and Lizards (Lizzies.) Reptilians have a highly sophisticated knowledge of universal law and are allegedly responsible for the Mystery School Teachings on Earth.

The Reptilians allegedly were given a creational agenda by the Carians. They were to move through the universe and destroy any existing civilization they found along the way, recreating new DNA codes and entities following those codes. It was part of a Master Plan, a Universal Game, Polarity Integration, reality in conflict, an experiment in emotions, resulting in soul evolution at the end of the cycles of its existence.

Reptilian - serpent - snake iconography is found throughout the planet in art work and petroglyphs, referring to the spiral of consciousness creation and human DNA. It is laced with metaphors about human origins and destiny. From the ouroboros to ancient myths, serpent references define our journey.

Description

Typically, Reptilians are described as 6 to 8 feet tall, bipedal, having scaly green skin, have a bad odor, have large eyes usually yellow or gold with a vertical pupil. They are sometimes linked to myths about ancient astronauts who allegedly came to Earth to seed the planet and promised to return one day.

Reptilian humanoids are a proposed race of intelligent, supernatural, or highly developed reptile-like humanoids in mythology, popular fiction, pseudoscientific theories and in the writings of New Age conspiracists. They appear in some conspiracy theories and in science fiction. Reptoids, a conjoined word defining Reptilian-Humanoid beings, is the most popular name used to describe these cryptid beings, although some may also refer to them as dinosauroids, lizardfolk or lizardmen. Other names include Draconians, Saurians and Sauroids. They are often described as being green or gold color

Mythological References to Reptilian Humanoids

Several ancient peoples all over the world have described reptilian beings, and some have described reptilian humanoids. Common in numerous mythologies are tales of reptilian creatures (usually not humanoid) who are often, but not always, hostile to human beings. Also rather common are the myths of "Serpents of Wisdom" who enlightened humanity before the dawn of civilization. (Could this be the origin of the serpent that appeared to Eve?)

There have been claims that mythological preeminence of reptilian forms could stem from a genetic memory of instincts developed millions of years ago, when mammals were the prey of the reptiles which dominated the Earth. Also, dreams of reptiles are often interpreted as symbolizing "ancient drives" and "instinctive responses".

The Toltec Mayan god Gucumatz was described as a "serpent of wisdom" who enlightened humankind. His Aztec counterpart was named Quetzalcoatl. In the Yucatan, he is called Kukulcan.

The Hopi refer to a race of reptoids called the Sheti, or "Snake-Brothers", who live underground. The Cherokee and other Native American peoples also refer to reptoid races.

In pre-Columbian mythology from Colombia, Bachue (the primordial woman) transformed into a big snake. She is also sometimes called the "Celestial Snake" (Serpiente Celestial).

Many users of the drug Dimethyltryptamine (the active ingredient in many South American shamanic potions such as ayahuasca) have seen reptilian humanoids or reptilian disincarnate entities and aliens while hallucinating.

Europe

Cecrops I, the legendary first King of Athens was said to have been half man, half snake. The ancient Titans and Gigantes were sometimes depicted as winged man-like beings with serpents instead of legs, such as on a fresco on a temple in Pergamum. In these images from Pergamum, some of which depict the gigantomachy, one sees the giant Klyteios with huge serpents in place of legs.

Boreas (Aquilon to the Romans) was the Greek god of the cold north wind, described by Pausanias as a winged man with serpents for legs.

The European dragon dates back to ancient depictions on various archaeological artifacts. An early instance in literature was the dragon that guarded the Golden Fleece in the Voyage of the Argonauts. In the Middle Ages, tales of dragons seem to have become even more common. The dragon in Europe, as a rule, was not conceived as having a humanoid form, and would not qualify as an instance of a reptilian humanoid unless explicitly described as humanoid.

India

In Indian scriptures and legends the Naga are reptilian beings said to live underground and interact with human beings on the surface. Some are alleged to turn human. In some versions, these beings were said to have once lived on a continent in the Indian Ocean that sank beneath the waves. Indian texts also refer to a reptilian race called the "Sarpa. The Syrietae of India were a tribe of men with snake-like nostrils in place of noses and banded serpentine legs.

East Asia

The Chinese, Korean and Japanese speak throughout their history of Lung (Yong in Korean, Ryu in Japanese) or dragons, conceived of in both physical and non-physical forms, but rarely depicted in humanoid form, though they may assume a non-reptilian human form.

The Japanese have tales of Kappa, a basically reptilian humanoid. In China, Korea and Japan, underwater realms where the Dragon Kings and their descendants live are referred to, as well as the lineage of humans from a race of dragons. This lineage was often claimed by Asian Emperors, who were believed to be able to change from human to dragon form at will, much like the

modern concept of shapeshifting reptilians. However, the dragon is seen as good rather than evil in Eastern tradition.

Middle East

In the Middle East, reptilian beings ranging from certain Jinn to dragons and serpent-men have been spoken of since ancient times. In one of the apocryphal books purporting to be the lost Book of Jasher, a serpent race is described.

In the Book of Genesis, God punishes the serpent for deceiving Eve into eating the fruit of the Tree of Knowledge of Good and Evil by decreeing, "Upon thy belly thou shalt go, and dust shalt thou eat all the days of your life" (Genesis 3:14 KJV). Traditionally, many have felt this implied that the serpent (a snake or reptile) had legs before then. Thus it is therefore often portrayed in Western art as a humanoid (woman) with a snake's tail, and sometimes lizard-like feet, as in a detail from Bosch's Last Judgement.

In the Middle Ages down to modern times, the Devil was often conceived as a humanoid with reptilian characteristics, as were demons in general. But the New Testament reference of Revelation 12:9 which identifies the serpent of Genesis as Satan himself (the "dragon, devil, Satan, ancient serpent," etc.) gives insight from another angle. The serpent in the Garden of Eden was Satan himself, a beautiful supernatural being (either called a "serpent" symbolically, or because he manifested himself commonly in a dragon/serpent-like form). Hence the reference to "crawling" and "eating dust" is purely symbolic of his ultimate defeat and humiliation.

Africa

In Africa, some shamans claim to bear extensive esoteric knowledge of a race of reptilians called the Chitauri, whom they say control the Earth. They also claim to have accounts of a reptilian race who created them and used them to work their gold mines. Also, the ancient Egyptian god Sobek was portrayed as a man with the head of a crocodile.

Modern Claims

Even in modern times, some claim to have encountered reptilian humanoids. In many of these cases, a UFO is part of the encounter; alien abduction narratives sometimes allege contact with reptilian creatures.

Scientific Speculation

In a thought experiment published in 1982, paleontologist Dale Russell, curator of vertebrate fossils at the National Museum of Canada in Ottawa, conjectured that, had the Chicxulub meteorite not exterminated the dinosaurs 65 million years ago, bipedal predators (theropods) which existed at that time, such as Troodon, would have evolved into intelligent beings similar in body plan to humans. Troodontids had semi-manipulative fingers, able to grasp and hold objects to a certain degree, and binocular vision.

Like most dinosaurs of the troodontid family, this imaginary creature, which Russell called the "Dinosauroid", would have had large eyes and three fingers on each hand, one of which would have been partially opposed. As with most modern reptiles (and birds), its genitalia would have been internal.

Russell speculated that it would have required a navel, as a placenta aids the development of a large brain case, however it would not have possessed mammary glands, and would have fed its young, as birds do, on regurgitated food. Its language would have sounded somewhat like bird song.

Russell's fanciful speculation has been met with criticism from other paleontologists since the 1980s, many of whom point out that Russell's Dinosauroid is overly anthropomorphic. Gregory S. Paul (1988) and Thomas R. Holtz Jr., consider it "suspiciously human" (Paul, 1988) and argue that a large-brained, highly intelligent troodontid would retain a more standard theropod body plan, with a horizontal posture and long tail, and would probably manipulate objects with the snout and feet in the manner of a bird, rather than with human-like "hands".

Darren Naish (2006) pointed to the ground hornbill as a better model for an intelligent dinosaur.

Artists have used these new approaches to the original thought experiment to re-interpret the Dinosauroid, going so far as to create "Dinosauroid cave art", which depicts sentient, tool-using troodontids and other dinosaurs and pterosaurs, painted using sticks and feathers.

Anunnaki

Zecharia Sitchin claims to have translated Sumerian tablets referring to an alien race which created a race of humans to work as slaves in their mines in Africa. This race is called the Anunnaki and Sitchin claims that the "Black-headed" people of Sumer were created by these beings by mingling the "life-essences" of "man and beast". According to Sitchin, the "Black-headed people" were considered slaves in the Sumerian caste hierarchy beneath their creators. The Sumerian Tablets refer to the creation of the Black-headed people in the geographical area called 'AB.ZU.', which is said to correspond to West Africa. See also Stargate.

The royalty was said to be a combination between "dragons" and humans, or to be direct descendants of the Sun God, Shamhash. Contrary to the claims of David Icke, the Draconian Sun-God aspect of the royalty does not correspond to the Anunnaki, but to a different set of gods. Anunnaki comprised only 23 gods in the Sumerian pantheon, including Enlil (lord of wind/air) and Enki (lord of earth).

Other gods were not Anunnaki at all, but were personifications of the Sun, or what were described as 'Sir', or Dragons, in Babylonian. This word, 'Sir', also apparently meant 'great serpent', and is related to the Sanskrit word 'Sarpa', which was also used to describe great "Dragon-Gods" who ruled over, and created, the original Dravidian culture.

Sitchin also suggests that the Annunaki probably still exist in some form or another, with some degree of influence over humanity. These beings are speculated to be either amphibious, reptilian, or quasi-reptilian, from ancient description.

According to Arizona Wilder, who claims to be a former mind-controlled subject of MK-Ultra (much like Cathy O'Brien), Zecharia Sitchin is in league with the reptilians as a disinformation agent. She claims to have seen him with other shape-shifting reptilians at many high-level functions attended by the world's "elite". Her claim to have been a subject of mind control makes her "eyewitness" accounts suspect.

Laurence Gardner, historian and holder of many other titles (the validity of which have been debated), claims that a "Dragon Bloodline" (a "Holy Grail") was created in ancient Sumer when reptilian aliens called "Anunnaki" descended upon the region and created a royal bloodline through genetic engineering.

Stewart Swerdlow, from NY, claims to possess extensive knowledge of alien intervention in Earth-human society, and describes in detail the activities of a Reptilian race called the Draco, originating in the Draco star system. He also mentions a more benevolent reptilian race called the Anunnaki, the Sumerian Program, which created the Black race in Africa. He claims that this is supported by ancient Sumerian tablets, as well as the histories of the indigenous peoples of Africa, such as the Zulu, as well as physical evidence such as ancient mines which have been discovered by the Anglo-American Corporation, dating to 60,000 years B.C.

Conspiracy Theories

Reptilians (also called reptoids, reptiloids, or draconians) are purported reptilian humanoids that play a prominent role in science fiction, modern ufology and conspiracy theories.

There are many conspiracy theories involving reptilian extraterrestrials, or terrestrials of reptilian lineage. Many posit that the so-called Greys are in fact reptiles, and should be categorized as "Reptoids", others that Reptoids are an entirely different species working with or in opposition to the Greys. Some have also claimed that they are capable of shape-shifting.

One of the earliest, modern-day reports is that of Ashland, Nebraska police officer Herbert Schirmer. On December 3, 1967, Schirmer claims to have been taken aboard a UFO that appeared just outside of Ashland, where he encountered humanoid beings, 4 feet 6 inches to 5 feet tall, who wore close-fitting silvery gray uniforms, boots, and gloves. Their heads were thin, and longer than a human head.

The skin on their faces was grey-white, the nose flat, the mouth merely a slit which did not move, even when they spoke. Their eyes were slightly slanted. While only slightly reptilian in their outward appearance, these beings bore a "winged serpent" emblem on the left side of their chest. Schirmer alleged that the beings are from another galaxy, and have bases on Earth.

John Rhodes was the first person to seriously investigate and publicly present claims of reptilian-humanoid sightings and/or contact. He established a Research Center in 1997 to collect, review and present evidence of reptoid activity. He has also appeared on television and radio shows being interviewed about his discoveries and the science supporting the theory of Reptoids.

Rhodes contends that the majority of the reptilian humanoids are descendants of the dinosaurs and are biological byproducts of Earth evolution. He also states that human attention has been intentionally misdirected away from the underworld toward deep space, so the subject of underground Earth dwelling Reptoids and lost ancient civilizations can remain secret. Rhodes also adds that most accusations of politicians shape-shifting into reptilian humanoids are totally unfounded, and that such reports are simply projections of collective fear and blame for the world's conditions.

When questioned as to why Reptoids have become the proverbial "whipping boys" of modern ufology, he responds that it is because people tend to have a knee-jerk reaction to the image that western religious authorities have conditioned us to fear and distrust. A subterranean Nazi-friendly super race is sometimes associated with accounts of reptilian humanoids, and also with the telekinetic super race depicted in *Vril: The Power of the Coming Race*.

Riley Martin, author of *The Coming of Tan* and frequent guest of Howard Stern, claims personal knowledge of Targzissians, a malevolent race of reptilians who manage to coexist with six other types of aliens on a mother ship near Saturn.

Paul Shockley, a self-professed psychic, also speaks of malevolent reptilian beings. However, he explains that he does not believe that all reptilians are malevolent, and that there are benevolent members of this species as well.

The Theories of David Icke

According to David Icke reptilian humanoids are the force behind a worldwide conspiracy directed at manipulation and control of humanity. He contends that most of our world's leaders, from George W. Bush to members of the British royal family, are in fact 7-foot tall, blood-drinking reptilians from the star system Alpha Draconia.

According to an interview with David Icke, Christine Fitzgerald, a confidante of Diana, Princess of Wales, claims that Diana told her that the Royal Family were reptilian aliens, and that they could shapeshift. David Icke and others have claimed that U.S. President George W. Bush and his family are part of this same bloodline (Icke, 2004). Icke claims, based on his exploration of genealogical connections to European royalty, that many presidents of the United States have been and are reptilian humanoids. In his view, United States foreign policy after September 11 is the product of a reptilian conspiracy to enslave humanity, with George W. Bush as a servant of the lizards.

He also theorizes that the reptilians came here from the constellation Draco. One type of reptilian entity that people see during alleged encounters resembles reptoids like those that are addressed in the studies of John Rhodes and the Reptoids Research Center. Like most conspiracy theories, proving Icke's hypotheses is impossible, but he continues to sell books and give speaking engagements based on concepts ranging from the New Age to his political opinions.

Others who share the negative viewpoint of reptilian humanoids include Cathy O'Brien, a woman who claims to be a victim of CIA MKULTRA mind-control. O'Brien says in her book "The Trance-formation of America" (with Mark Phillips) that she witnessed George Bush Sr. physically shapeshift into a reptilian alien being. She rationalized this as potentially being a holographic illusion as part of her mind control programming. Arizona Wilder reported similar sightings of prominent politicians shape-shifting into reptilian beings during Illuminati blood rituals. While her claims sound frightening, no supporting evidence or additional eyewitnesses exist.

Patrick Bellringer and other supporters of NESARA also claim that George Bush is a reptilian. In this scenario, the announcement and implementation of NESARA (a law passed in secret) will ultimately end reptilian control over the planet Earth.

SPECIAL PULSAR APPENDIX

From file m231 (Not for public release)

Binary Star Orbit

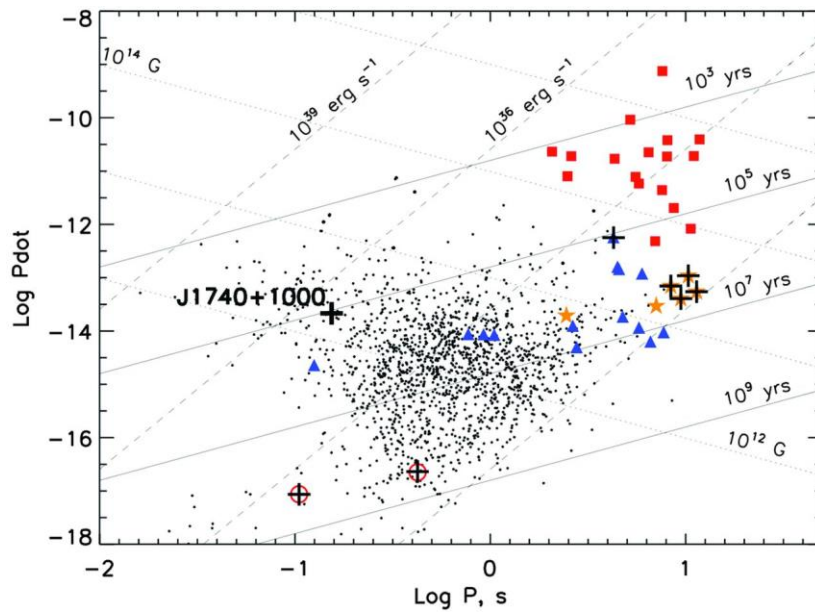
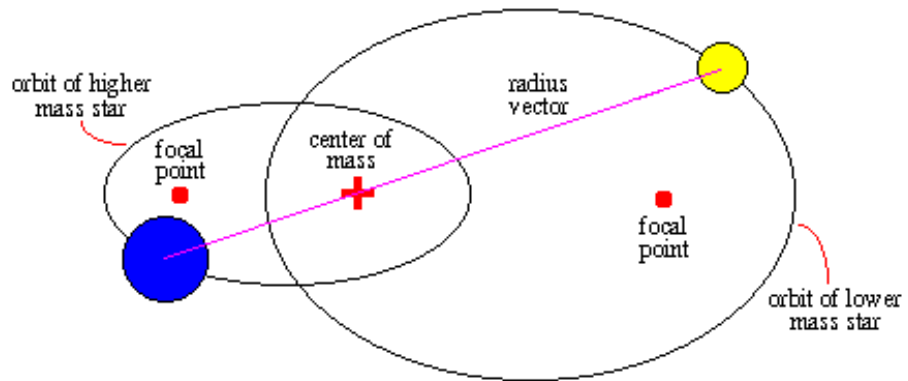

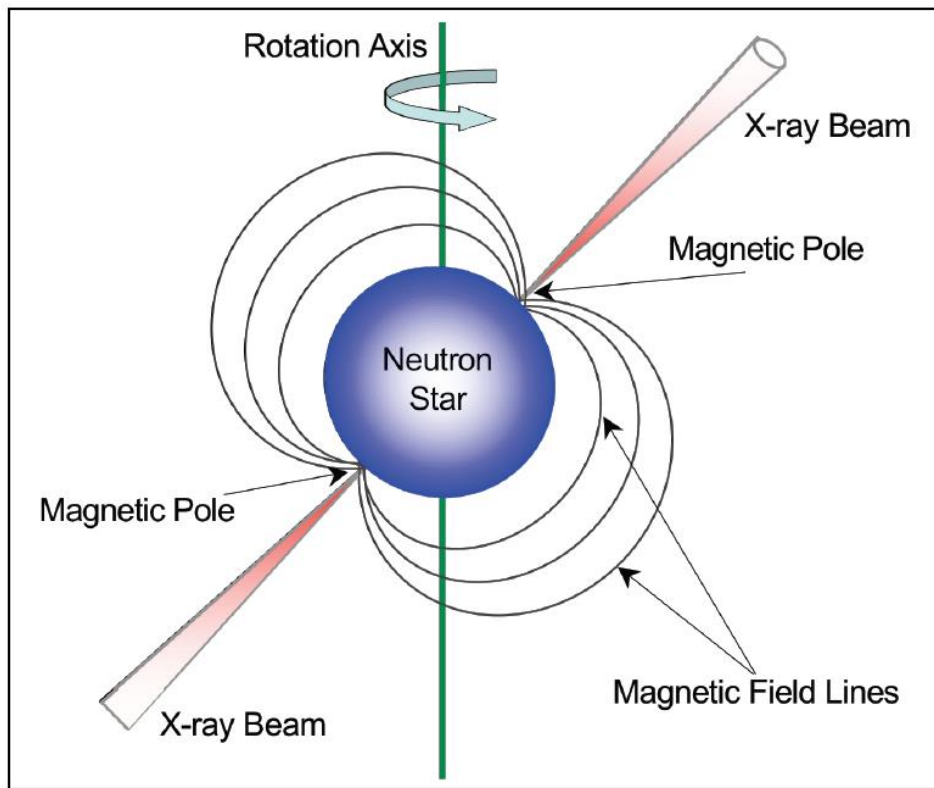
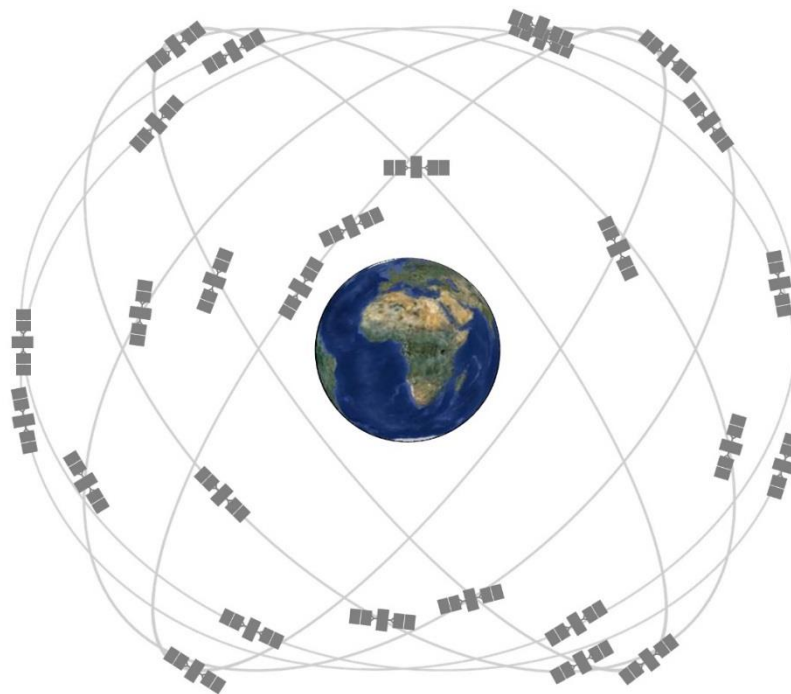
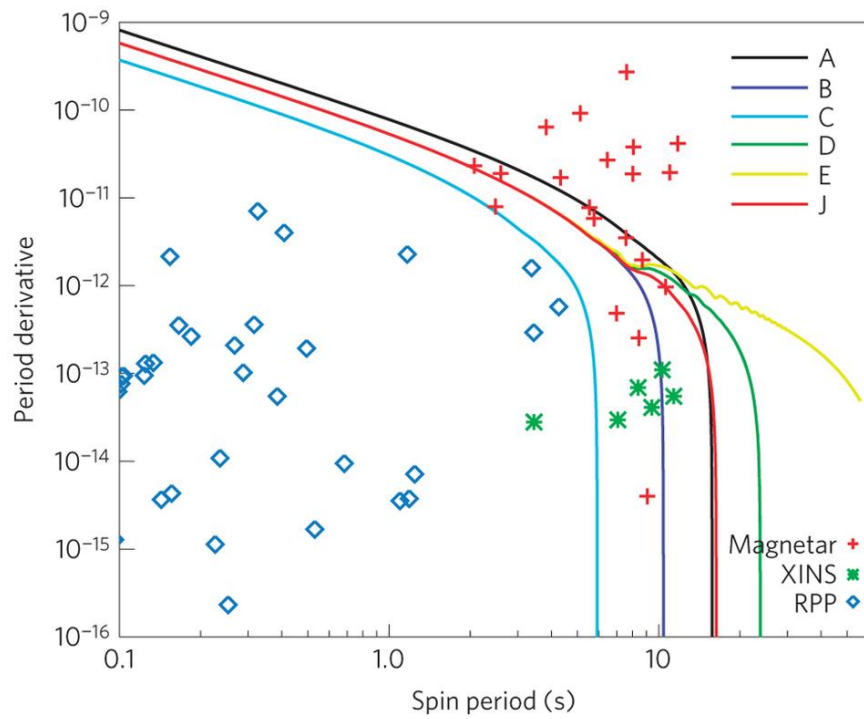
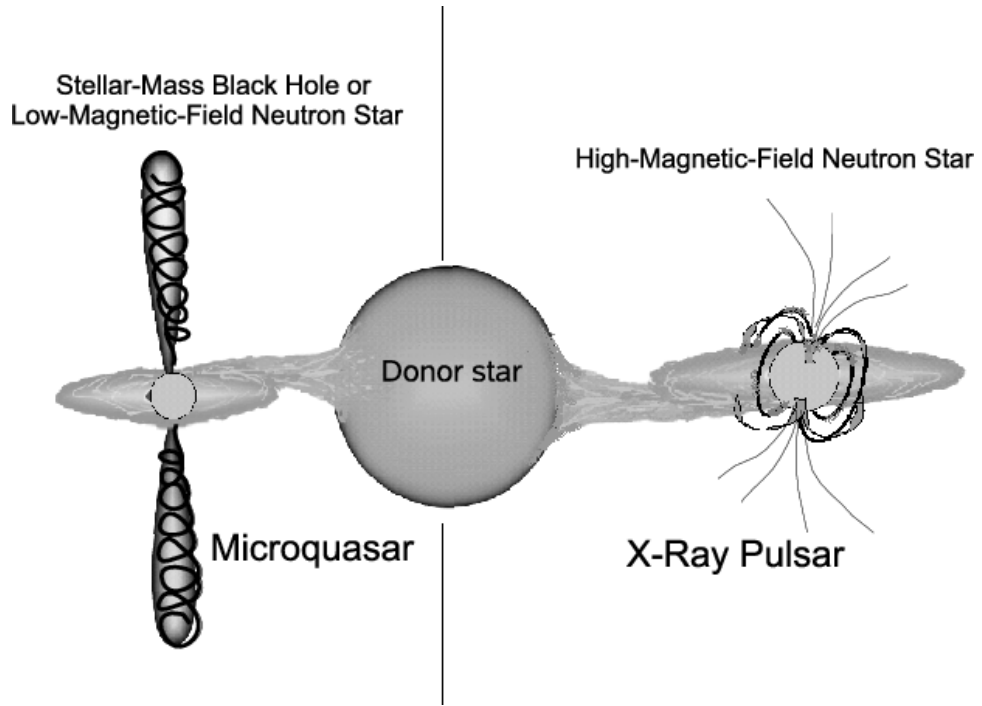
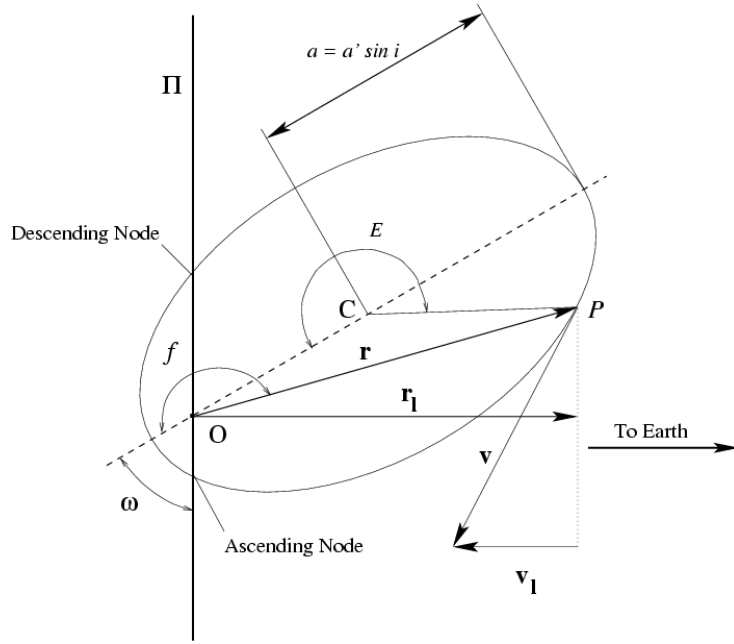

Figure 2-6. Diagram of pulsar with distinct rotation and magnetic axes.







Extra solar planet and pulsar

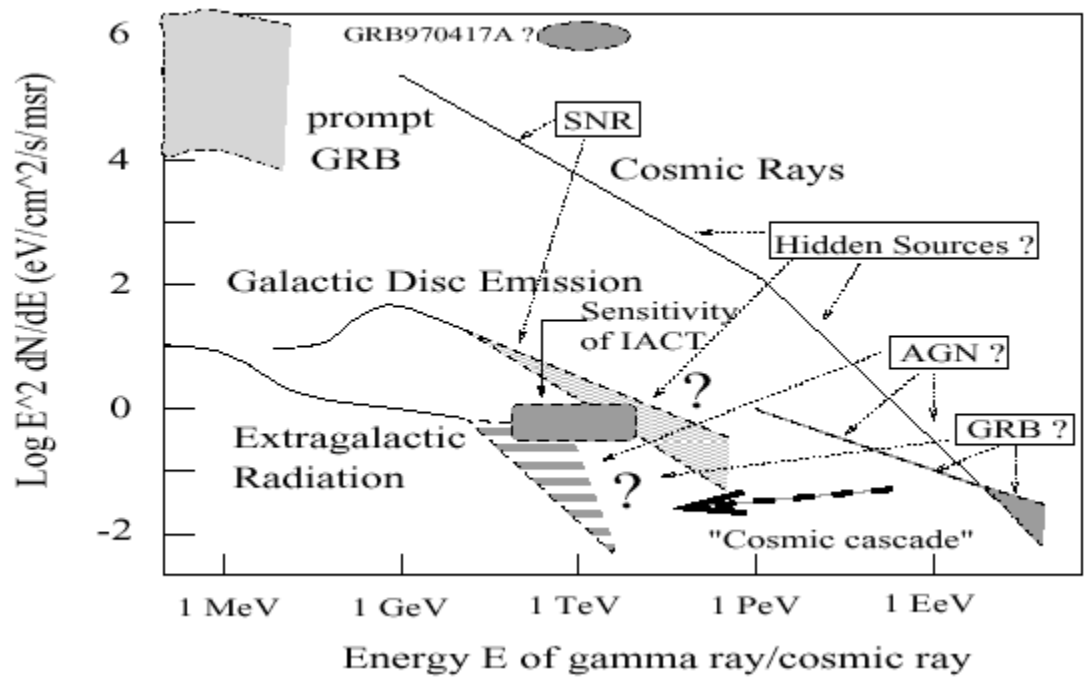

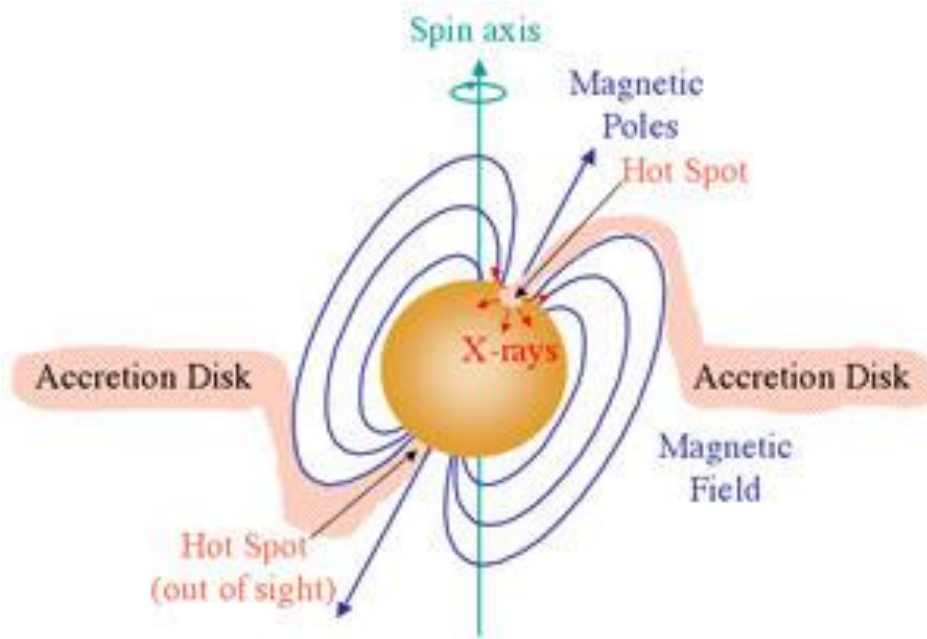

CODE: ARAMIS IV-ADR4-15SM

BLUE PLANET PROJECT



CONSPIRACY

FOR YOUR EYES ONLY

BLUE PLANET PROJECT CONSPIRACY



For the first time the full story of the Blue Planet Project is revealed...
Discover why the military and Intelligence agencies hate it!

*The scorpion that will come back to
sting those who have turned it loose!*

(A paraphrase of a comment about the Blue Planet Project
Book made to Jefferson Souza by an agent of NSA)

ISBN: 978-0-9914942-8-6

By Gil Carlson

(C) Copyright 2016 Gil Carlson

Blue Planet Press
Contact us at: BluePlanetPress@aol.com

To discover the rest of the books in this Blue Planet Project Series:
www.blue-planet-project.com

Here's What's Inside

The Secret of the Blue Planet Project Books...	3
How did Gil become involved in this Blue Planet Project strangeness?...	6
Maybe The Blue Planet Project really is a hot potato!...	8
More on the International UFO Congress...	9
A Closer Look at The Blue Planet Project Author...	10
Jefferson Souza has been Found! ...	11
The J.C. Emails...	11
Jefferson Souza's Defense Blog...	23
Letter to You (as a Reader of this Book) From Jefferson Souza...	28
Example Edward Snowden knew about before he fled...	30
Letters from the Real Jefferson Souza...	30
Statement on the Crash Landings of Anomalous Aircraft and Devices...	52
SpacePort Under Death Valley...	54
Secret Intelligence Files of Jefferson Souza...	57
Alien Involvement in Earth's Recent History...	59
UFO Crashes...	67
Are Many of the UFO Sightings Today Actually Ours? ...	74
Signs of Possible Alien Abduction...	77

Jefferson Souza

The mysterious man behind the Blue Planet Project.
We are now revealing many of his secrets!



The material in this book has not been submitted to or approved by any U.S. intelligence agency. If anything is discovered that is considered by your agency to be classified, notify the publisher.

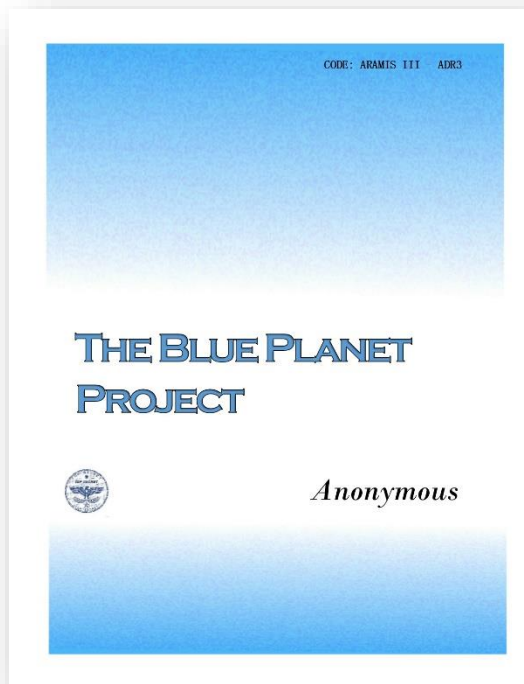

The Secret of the Blue Planet Project Books

The Blue Planet Project Book was shrouded in mystery. If you haven't read it yet, it is available at:

<http://www.blue-planet-project.com/>

It was claimed that it was from the notebooks of a government scientist who was contracted by the government, over several years, to visit alien crash sites, interrogate captured aliens as well as analyze all data obtained from government sources.

And then when the government

realized either that he had in his possession these notes, and/or that he was going to reveal this information to the public, he supposedly went into hiding out of the country as soon as he realized he was in grave danger.

It was also stated that he was involved in these alien and UFO investigations for over 33 years and went into hiding in 1990.

The author's English was a little rough and the spelling wasn't too good. This led several readers to comment that it couldn't have been written by a scientist, it just didn't have the scientific polish.

And some have commented that it must be for real, as no one could have an imagination good enough to invent all this stuff.

Skeptoid claimed that the Blue Planet Project is: "An organized research project to catalog our knowledge of alien life and extraterrestrial civilization. The Blue Planet Project (not to be confused with Project Blue Beam, or the Project Blue Book) is nothing less than an **Alien Technical Manual** that serves as an encyclopedia of what we know about alien races, weapons, technology and plans.

Supposedly written by **UFO expert and scientist Jefferson Souza**, the Blue Planet Project made waves among the UFO community for its level of detail and commitment to disseminating forbidden knowledge."

Well, I'm here today to tell you that I have irrefutable proof that the basis of this story is true, while many of the smaller details need to be corrected. And after you read what I have discovered, you will surely agree with me that it is a true story that's even more bizarre than the original version!

Could it be that the **information in the Blue Planet Project** was the basis for many of the books and articles written by UFOlogists? Is this where much this information originated?

What about what we heard over the years about government cover-ups, false flags, surveillance, and even CIA assassinations that we just couldn't believe at the time, but now we are starting to realize that they are most likely true?

And the science fiction of years ago that seemed so way out that it was silly to even consider such a thing as being possible, such as Man going to the Moon or even Mars, particle beam weapons, SDI, aliens actually on our planet, and now they are becoming a part of our world!

Whenever we get ahold of information such as is revealed in this Blue Planet Project Book, we must consider not only is it real or not, but also why it was released.

Is it fiction, fiction written around some basic facts, or fiction released by the government as disinformation to throw some people off the track of what is really happening? Or is it real and a government employee wanted to reveal to the public what the government was actually up to?

Paul Bennewitz was anonymously given some tapes by what appears to be a government agent involved in disinformation on such things as Majestic 12. Now either they were similar to what was really going but not the whole truth to send everyone off on the wrong path or the government may just have been using him to spread some actual information so the public gets more used to the idea that there are actually aliens involved in our affairs.

I believe that Mr. Bennewitz actually did stumble upon and record some transmissions that really did originate from UFOs or were top secret communications involving the military in a secret project or a combination of both. Bennewitz was no dummy, He was very savvy when it came to electronics and communications.

The government went to a lot of trouble to make him look foolish and to drive him crazy and they finally succeeded in confining him and giving him shock treatments. If he was just some harmless nut, would the government really care and waste their time with him? This has been the government's most effective trick over the years, to get the public to laugh at you if you mention seeing a UFO or even believing in them. And it has really worked! How many folks who have witnessed something bizarre in the sky will never say a word for fear of being ridiculed and maybe even losing their job or their standing in the community?

I heard that the founder of the Enquirer tabloid originally worked for the CIA and that they funded the money for him to start it. One of the goals was to run ridiculous exaggerated articles and pictures on aliens and UFOs in order to treat the subject with ridicule so that most mainline newspapers wouldn't touch the subject for fear of being compared to the Enquirer.

How did Gil become involved in this Blue Planet Project strangeness?

I must tell you that up until 2013 I had never published a book on aliens and UFOs. But this was a subject that had always fascinated me. Just like you, I read everything I could get my hands on to find out what was really going on, but most of the available books just didn't seem to reveal enough about what was really happening.

I spent most of my life in marketing. First creating direct marketing companies, then as a marketing consultant and finally full time in the publishing business, writing and publishing books on marketing, copywriting and book writing.

Then in September of 2013, all this changed. As an Amazon book dealer, I received an email from Amazon notifying me that a book called "The Blue Planet Project" was no longer available and that there were a large number of potential customers looking for it, and that I should try to locate any of these books that I could find.

I had never heard of it before, but it intrigued me. And soon I was pulled into this mystery. My research revealed many contradicting stories: Strange, cryptic postings in chatrooms; Copies of hard-to-read parts of the book posted on websites; and an eBook being sold, but had many reviews warning of the hard-to-read quality of it.

I did find the listing on Amazon for a copy of the book in print. It was being sold by a print-on-demand publisher, but was no longer available. It started selling on 2/25/13 and ended about six months later. The information was sparse. Rather cryptic explanations as to why the author was listed as "anonymous" and why no one was taking credit for it.

I did finally manage to get a copy of the original and complete manuscript and arranged to get the legal rights to publish it in book format, registered the ISBN number and started selling it on Amazon. There was a great response from followers who thought they would never be able to obtain a copy.

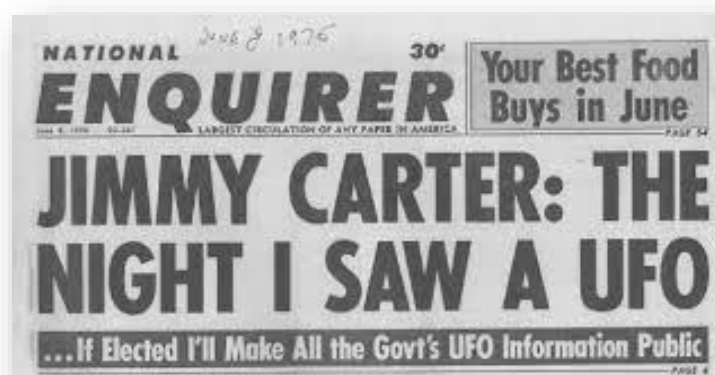

Then in December of 2013 (about three months after Amazon encouraged me to bring it out again) I get an email from Amazon, they (or someone) seemed to be unhappy with it being sold again (very interesting!) They mentioned some reason which really didn't apply and said they were banning me from selling the book. If I had done something wrong or went afoul of their policies, they would have banned me from selling on Amazon, instead they just banned me from selling this one book! Such a strange world!

Fortunately, I had already created the website www.blue-planet-project.com/ and the Blue Planet Project was selling there. Then less a year later I was able to sell Blue Planet Project on Amazon again.

Did I ever consider that maybe the Blue Planet Project had a black cloud hanging over it and that maybe there were organizations that didn't want it being made available to the public? Yes, every day!

But I was intrigued about being a part of something with such powerful information and an almost cult-like following of readers who were very appreciative. I remember a reader in Australia who emailed me that he and his group of friends were amazed that I was able to get away with publishing it, that people have been shot for less. (Wait until he reads what I revealed about Australia's Pine Gap Base in one of my newest books: "Alien Underground Bases"). It can be seen here:

<http://www.blue-planet-project.com/Alien-Underground-Bases.html>

Last year, a customer who was very grateful to have finally obtained a copy of the Blue Planet Project, explained to me that he was a UFO researcher and a few years ago he was searching for the Blue Planet Project he had heard so much about. As he attended many of the UFO conferences and was acquainted with most of the speakers, he asked one of the top UFOlogists there if he knew where he could get a copy of the Blue Planet Project and was told that he shouldn't even mention that book, it was too dangerous. And then he noticed, on several occasions afterwards, that he was being followed. Very bizarre!

And then there's the reader who said that Blue Planet Project was so revealing that he almost felt it was illegal for him to be reading it! Several said they were glad to get their books before I got shot. Encouraging, right?

But I was hooked. I put all my other business interests on hold and devoted full time to the Blue Planet Project. And then writing books that expanded on the themes mentioned in the Blue Planet Project, such as Dulce Base and Remote Viewing Aliens. This book is Number nine in the Blue Planet Project series.

Are the Men in Black more common than we have realized?



Maybe The Blue Planet Project really is a hot potato!

Here's an old news clipping I found online of an incident which maybe gave Jefferson reason to be cautious:

RESEARCHER BEATEN UP BY MIB/CIA -- MAY 1990

Researcher Jefferson Souza [Vegan - Ummo Contactee] arrived at a UFO Conference in May of 1990 bearing information that included data about which corporations were producing helicopters with gravity assist, as well as information about their use in cattle mutilations. Four men appearing like classical MIB (Men In Black), took the documents, and threw him back on a plane to New York. It may well be that CIA/Delta/NRO involvement in the mutilations might be more significant than supposed.

And from a posting online:

The original Blue Planet Project Notebooks were handwritten by their owner at the First International UFO Congress held in Tucson Arizona held from May 3rd thru the 7th in 1991. The notebooks were grey Composition Graph Notebooks with sketches, diagrams, formulas, charts and information about Extraterrestrial data collected from various sites around the world.

More on the International UFO Congress



The Congress was founded by Lt Colonel Wendelle Stevens, retired US Air Force pilot turned UFO investigator and researcher. Lt Col Stevens was assigned to Wright Field in 1946, and his research on UFO's began there with all of the information about the Roswell crash in 1947.

Lt Col Stevens was assisted with his Hosting duties at the Conference by his good friend Command Sergeant Major (ret.) Robert O. Dean, who claims he saw a "Cosmic Top Secret" briefing document on UFOs when he worked on the General Staff at SHAPE (Strategic Headquarters, Allied Powers Europe) in the mid-1960s.

The Conference theme was: Extraterrestrials Are Visiting Earth.

Could the two mentioned above (Stevens and Dean), have been responsible for passing info to Jefferson Souza?

A Closer Look at The Blue Planet Project Author



Gil Carlson, Blue Planet Project Publisher

Since my involvement with the Blue Planet Project beginning in September of 2013, I have attempted to revive and fulfil a demand for what may be considered a cult classic as well as an amazing revelation and exploration into the world of aliens, UFOs and government involvement with them. As a publisher, I worked at my task of making this book available to the public, all the while there was a swirl of confusion around me. So many rumors and questions kept popping up. Even folks posing as Jefferson Souza online for whatever reason.

As I kept trying to find answers, and people warned me not get involved with it, I knew the truth had to come out. Was Jefferson Souza the actual author? (I assumed from the beginning he was, but had limited evidence).

Was he really a government employee who had turned whistle-blower? Was he still alive or had a government agency finally succeeded in terminating him? Or maybe (this seemed the logical conclusion to me) he was still hiding out in some foreign country? I always figured I would be in touch with him some day.

Well that day did finally arrive, I've been in touch first with his representative, J.C. and then with the real Jefferson Souza! Some of what I've learned may surprise you. Are you ready for it?

But first I must clarify a few things: My involvement in this is strictly as a reporter. It is not my endeavor to promote, defend or condemn the actions, efforts or activities of those I have been in contact with. It's too easy to automatically condemn the actions of the government without knowing all the facts, just as you shouldn't believe all the evidence the government presents against an individual without examining it closely and hearing the other side of the story.



The residence of Blue Planet Project author Jefferson Souza

Jefferson Souza has been Found!

In June of 2014 I received the first of many emails from someone I refer to as J.C., He introduced himself as a friend of Jefferson Souza who was helping him handle some of his financial and legal affairs.

Thus began a lengthy communication back and forth as he explained what really happened to Jefferson and he was able to answer many of the questions that I had. I'm sure that you too will also find this information to be very intriguing.

On the next dozen or so pages I'm going reproduce information from these emails, they have been shortened by dropping anything irrelevant or personal, but everything important has been retained. So let us begin:

The J.C. Emails

Email from J.C. 7/9/2014

Jefferson is 55 years old and has been in a US Federal Prison under a false name since 1996. He has written many books over the past 18 years but he is unable to get the information out. It is a long and bizarre story but basically, the US refuses to correct his identity so that he can be released back to Brazil even after the Brazilian Consulate has confirmed his identity. They do not want him released for many reasons.

I know this for a fact because I was in two prisons with him and I am the one who personally found and contacted his family in Brazil after they thought that he was dead. The US refused to inform his family of where he was for 18 years and they still refuse to **correct his identity so they don't have to release him.**

Believe it or not but I have proof. Don't bother to respond if you are afraid of having the US government reading your letters to and from Jefferson.

Thanks, J.C.

Email from J.C. 7/9/2014

Hello Gil,

You may be suspicious of my story and I am doubtful that you will contact him when you understand that the Feds do not want him released. I say this from experience with two other UFO bigwigs who were all into the story until they realized that they would be closely monitored by the Feds if they started writing to him. They never did gain the courage to write to him and I wasted weeks explaining things just as I have spent years trying to get him identified and released to Brazil.

I don't fear the Feds myself because they already know and hate me because I blatantly inform the public of their unending corruption. They like to pretend that they are upholding "Justice" when their entire system is based on lies and corruption. From the day that I was arrested by them, I have never heard a "Justice" official tell the truth.

Jefferson was traveling the world doing his UFO studies, speeches, etc. and he used his early programming skills to break into various defense databases and got information and photos. He was a very early version of WikiLeaks for UFO content.

His travels and interests in computers, hacking, etc. cost a lot of money and granted, he committed crimes to get money etc. and he used false identities for some of this. He had several run-ins with the Feds over the years but they always let him go.

In 96, they arrested him on highly dubious kidnapping charges when they claimed that he kidnapped a 16-year-old boy on a greyhound bus?? He was carrying a Venezuelan passport at the time under the name of a Venezuelan military officer.

Venezuela had issued him that real passport for some service that he was performing for them which I am not sure of. Read between the lines and I think he was spying for **Venezuela while doing the UFO hacking in the US. He doesn't admit to the spying but it is** the only thing that makes sense.

Of course, the Feds couldn't win in his first trial when the jury wouldn't unanimously say that he was guilty of kidnapping a teenager on and public bus so they arranged to have him beaten and raped while in a locked protective custody cell on the night before his second trial. The Federal judge refused to delay that trial and he appeared there doped up from the pain and in a wheelchair.

They won that case when he couldn't testify. A complete corrupt Federal trial that was allowed by a Federal judge. They locked him up for 26 years under the false Venezuelan name even after he informed them of his true identity and country.

I met him in prison and heard this crazy story and took it with a grain of salt. I also spent days and days reading his writings and looking at his UFO drawings. When I got out, he asked me to see if I could help him and I decided to use the internet to verify what he had told me. Very quickly, I was reading UFO writings online from Jefferson de Souza which read exactly like the ones that he had handwritten in prison. I knew that it was the same author. I also was finding that Jefferson disappeared in the mid-90s exactly when he was locked up.

I then thought it would be an easy matter to correct his identity but after years of trying to do it, I started seeing that they did not want him released even if it was directly to Brazil. Not only do the Feds not like what he was discovering about their files, they now have to cover up the attack that they arranged on him in order to get his conviction.

They let his Brazilian family believe that he was dead for 18 years because they know that his family can request that he be transferred to Brazil to finish his sentence and the Feds know that if he gets to Brazil, they will immediately release him because of the sham trial. When he gets released, they know that he will sue the US for all of this and this story will get out causing untold problems. The US Justice Dept. wants to pretend that they are pure and incorruptible and they do not want this story out.

I finally succeeded in finding his family on Facebook and informed them of all this and they are now trying to get him released to Brazil but of course the Feds refuse. As I said, the Brazilian Consulate has confirmed his identity and requested a photo from the Justice **Dept. for his new passport and the Feds won't give** them one. They know that once they give up the photo, there is no stopping his release to Brazil and this story getting out through lawsuits and media. They insist that he is Venezuelan even after Venezuela and Brazil have informed the US of the truth.

Jefferson has a lot of information both in his head and hand written about what he had discovered from his hacking. They sometimes raid his cell and remove years of hand written books but some things he does not write down. Jefferson is not a normal person, he is a person who the US wants kept silent and unidentified and they have found a way to accomplish that so far. They do not take kindly to my efforts and they will not of yours if **your dare to either find out things they don't like or decide to help this** poor man.

Email from J.C. 7/18/14

The picture in this YouTube video is the real Jefferson de Souza. You will see by my post on there that I am trying to track down who posted that video and where they got that authentic Jefferson picture of him in his prison t shirt and government issued eyeglasses.

Email from J.C. 6/22/15

Hello,

Do as you will as we are trying anything and everything now. The roadblock is always that people really cannot believe that their government is this corrupt unless they have dealt with them directly themselves.

The Consulate has now issued him a new, valid Brazilian passport and yet as you see, the Feds refuse to truly identify him on the BOP database. They are terrified of him getting enough help to be released, start publicizing their corruption first hand and suing them all from Brazil.

I have created a new blog to point people to. Copy and paste whatever you can use or just link to it. If you know people with money who truly hate what has happened, there is no better investment than to donate to Jefferson as he can truly use anything from stamp money to lawyer fees.

Email from J.C. 7/2/15

Hello Gil,

I recently looked at your updates on your website and thank you on behalf of Jefferson for your attention. I have personally taken great care in that blog to link people directly to the government's own ridiculous court documents, newspaper articles from the time of Jefferson's trials, as well as providing Jefferson's direct mailing address as Richard Romero. I did these things so that people do not have to take my word for anything. I don't know of any way further to be as straightforward as possible.

I would ask you and your readers to consider a few basic questions. Why is the US government still listing Jefferson de Souza as Richard Romero, the Venezuelan military officer, even after the Brazilian Consulate has confirmed and issued him a new, valid, Brazilian passport?

How did a gang of thugs just happen to be running loose in a Protective Custody wing of a major US jail, let alone have a locked cell door opened for them, on the night before Jefferson's second trial? That alone is impossible without direct assistance and instruction by jail staff and higher.

Why was Jefferson suddenly transferred from a Federal Medical Center near Boston to a private prison contractor prison, GEO, in South Carolina when it became clear that we were making progress in truly identifying him? Why would the US government refuse to identify this man or even inform his family in Brazil of his whereabouts for almost two decades?

These basic questions as well as many others go unanswered because the real answer is obvious, the US government wanted this man locked up and hidden away for decades and they did whatever was necessary to accomplish that. They point to his UFO background and writings as reasons to tell people to doubt everything that he says which of course helps in their cover-ups.

These are the same people and agencies that for decades told everyone that Richard Romero was a crazy, lying, UFO nut who was making up the claim that he was the Brazilian citizen named Jefferson de Souza. Who was lying in that situation and who has lost all credibility in all of their statements and actions? The liar was clearly not Jefferson; it was the US government.

Email from J.C. 7/2/15

Any help of course is appreciated but that one topic is a very sore subject. Their largest tactic against their enemies is the, "they are all crazy liars," and they use it very effectively against UFO witnesses as well as anyone who they deem cross their purposes.

Jefferson is well aware of the dangerous situation that he is in with this new blog and we are both well aware that they know who created it. I got Jefferson's specific approval for that blog before it was created for these exact reasons but I had run out of ideas to assist him without the blog. It took years for me to get him identified and to find his family without that blog. Even now, people cannot believe that their government would do such a thing.

They are brainwashed to believe in their justice system until they have to confront it themselves. I find people who swear to me that this story is impossible simply because the US government would never imprison someone who was unidentified for 20 years. They swear that this is impossible even as they are looking at it happening today with Romero/Jefferson.

Most of the major UFO guys that I have dealt with on Jefferson's behalf have run for the hills when it sinks in that they are really going to be dealing with the Feds if they get involved. I see now how the Feds can force silence on the UFO issue and any other. At least with the blog, people have the choice to deal with Jefferson directly or to remain anonymous and deal with me on his behalf. I spent four years as a US Army Infantryman so I know what the real US government is supposed to be.

Any help with linking his blog into Brazil would be helpful as I now believe that that is what can get him released to Brazil. If the population and political class in Brazil could hear this story, they would be up in arms until his return

Email from J.C. 7/15/15

Gil,

To give you an idea about Jefferson's personality and how his work could have been used by others, think of a modern Tesla. I am not saying that Jefferson is on the Tesla intelligence level of course as I doubt that any human has ever been but Tesla was robbed of millions by Morgan, Edison, Westinghouse, etc. Jefferson's mind goes a million miles an hour and he produces pages and pages of notes and drawings but his world and

business sense is terrible. He is very hard to keep focused as he is extremely intelligent. That is what made me start to take him seriously when I first met him and heard his stories, he was simply much different than any other inmate. It wasn't until I got out and got on the internet that I discovered why he was so different, he was telling the truth and the government was railroading and hiding him.

Jefferson has had many handwritten books taken from his cell and never returned. He has lost dozens of complete books over the past twenty years because they raid his cell and take them and never return them but he just starts over and writes more. I will attach the handwritten page that I told you about and you will recognize his writing immediately. No one else has ever seen this page. (you can see it on page 52)

Email from J.C. 9/6/15

There is something very unusual about Jefferson and it seems that no one has ever totally figured him out. You will see stories singing his praises and you will find stories of people saying that he is a fake but even those stories describe very strange occurrences. Tom recounts a story where Jefferson was beaten and injured by unknown men or a car crash in New Mexico, he never knew which, and Tom personally saw a very large cut on the back of Jefferson's neck. A few days later, Jefferson flew to Toronto and Tom reexamined his neck and found no cut and no scar.

Tom is a very nice guy and if he isn't answering my emails then something is really wrong. He loves to discuss Jefferson and his past exploits and was ecstatic when I informed him where Jefferson was.

There are many stories like this even from people claiming that he is fake, especially the ones from when he was in Spain. I can only claim that there is something very unusual about Jefferson and he knows things that he really shouldn't know.

The one thing that always jumps out to me and seems to always be overlooked is the money. This guy never had a job and yet he always had the latest computer technology and he traveled the entire world?? How? Some of the stories claim that he was employed by the CIA to spread misinformation about UFOs but I believe that what he says is more accurate. I do believe that he was a spy but I believe he was spying and being paid out of South America and was gathering information the US Feds didn't like him gathering. He was arrested with a valid Venezuelan military officer's passport with Jefferson's picture and fingerprint on it. I saw that with my own eyes.

Email from J.C. 9/7/15

I just now received an email reply from Tom. He is better.

I just received a letter that came on Saturday from Jefferson and another UFO guy named Mike Cristol just wrote him that the internet is blowing up about Blue Planet Project again.

Email from J.C. 9/12/15

Gil,

Received a letter from Jefferson today. Apparently one of the big UFO guys in Brazil has been writing to him. He runs a big UFO website and group in Brazil and he wants to work with Jefferson when he gets back there

Email from J.C. 9/17/20

One of their pathetic ploys to keep him hidden is to interrupt his mail. You will soon find out that they have a manic desire to keep this guy hidden but they have already failed. Once Brazil confirmed him and issued him that passport, even though they had to go around the Feds roadblocks, he has been gaining support.

They recently handed him dozens of letters from around the world of people offering him support and even trying to mail him items and money.

This government and all of its agencies seem hell bent on causing this one guy as many problems as possible and it cannot always be coincidental. They do not seem happy enough by rigging a trial to imprison him for 26 years, they have to torment him as well. Those bastards are sick in the head. I do not know for sure what it is that he had found or seen in their databases and I am not even sure that he knows exactly why they hate him so much but something has caused all of this.

The US is simply a gigantic business which is in the business of making money and it responds in a knee jerk fashion to any perceived threat to its hidden agendas. They need their image to be the world's example of Justice and Fairness and Law and Compassion and on and on with their bullshit and they attack anyone who wants to tell the world of their real corruption.

What is more corrupt than imprisoning a guy for 26 years under a false name and letting his family think that he is dead? They actually thought that they gave him a life sentence because without a valid passport and country accepting him back, he could never be released. I kind of blew that plan out of the water for them as Brazil now knows about him and he is becoming more and more famous again.

The US military routinely goes into other countries, without their permission, and performs whatever missions they are told to do. That is why I call VA disability payments, bribe money and not medical payments. They bribe veterans to keep quiet if they want to get paid.

I can see how someone wanting to report a UFO could be immediately targeted for threats or charges of insanity if these bastards want to keep them quiet. That is exactly what they have done to Jefferson for almost 20 years.

Email from J.C. 10/13/15

Gil,

Received a letter from Jefferson and he did get the books that you sent. You should be getting a letter from him soon. They raided his cell and took back a lot of the letters that he had from supporters because so many letters were a "fire hazard." He didn't even get a chance to answer them all. You know what I am going to say to that!

Email from J.C. 10/20/15

Gil,

Why is he still listed on the Federal inmate look up as Richard Romero when he has a brand new Brazilian passport telling the Feds that he is Jefferson??? Why would the Feds choose to list him falsely?

These FACTS go on and on if anyone wants to research them but they keep saying it is fake or that I work for the Feds trying to entrap UFO people who know too much!! This is exactly what I have been dealing with for years with them.

Email from J.C. 10/20/15

Gil,

I just forwarded you an email showing two things. First, you see the email from the Atlanta Consulate CONFIRMING that he is Jefferson Borba de Souza. Second, you see my email informing the BOP about his true identity.

About six months after that email was sent, and after endless roadblocks about getting a photo of Jefferson for the passport, the Brazilian Consulate in Atlanta provided the BOP a new, valid, Brazilian passport for Jefferson de Souza.

These are all provable FACTS.

Email from J.C. 10/26/15

Gil,

Now you see what I have been saying and writing about. You have to look back 20 years to make any sense of this at all and you will see that they want to keep this guy locked away. He found/saw something that they do not ever want him discussing so someone with a lot of pull came up with this plan.

Not only did they effectively convict a man while he was doped up in court which is of course illegal. They purposely listed him under an alias name and nationality for only one reason. It was supposed to be a life sentence. An illegal alien has to be accepted by their home country after their sentence in order for the US to release him.

There are many Cubans still in Federal prisons long after their sentences because Cuba will not accept them back. Venezuela has told the US many times that he is not Venezuelan and that they will never accept his release as Richard Romero, their military officer.

The Feds knew that by not informing his family that he was alive and by telling everyone that he corresponded with that he was a crazy liar; he would never be released

anywhere. Now that plan has been ruined because Brazil confirmed his true identity and moved forward with issuing him a new passport even if they had to use an old photo. Now he has a release country and possible early release by getting a treaty transfer. A treaty transfer basically gets him transferred to a Brazilian prison but once there, the Brazilians will review his case and surely release him immediately because of time served on that ridiculous case and trial.

I don't know what he saw and I am not even sure that he knows what it is that caused this kind of a scheme but someone wanted him not only in custody, they wanted him hidden from his family and the world forever. I have been trying to point this out to the UFO crowd with little success. With him, they have proof of exactly what they have been claiming. The US has imprisoned a famous UFO investigator with a ridiculous case and sham trial and hidden him away in their prison system for 20 years.

They insist that he is a crazy liar until someone investigates his claims and discovers that he has been telling the truth and they have caused all of this and have lied continuously. This all did not happen for no reason. Many Federal officials committed serious crimes in this case starting with the court knowing/ordering that attack in order to get a conviction in that second trial.

The judge had to know/see that he was completely doped up and unresponsive in that ridiculous trial. This is a real life proven case of what the UFO crowd claims about a corrupt government but they don't even see it or they are too terrified of the Feds to help. That is why I say that they are all talk and no action.

From a US legal point of view, they always fall back on the 7-year statute of limitations which is why I now focus on Brazilian legal help. Brazil won't care about the US cover-up laws when they see what the US has done to their citizen.

If you feel really brave, hand deliver a printout of his blog to the Brazilian embassy in DC. If I lived near DC, I would be living in the Brazilian embassy lobby until they let me speak with the Ambassador as I am sure the Brazilians would go ballistic if they took the time to really see what has been done to their citizen by the US government.

An actual novel of this guy's life, especially this past 20 years, is a worldwide blockbuster book and movie. The US government set up a sham trial and purposely imprisoned a guy for 20 years under a false name and nationality because he saw something in their databases. Hollywood could not come up with a better story than this.

Below is from Jefferson Souza's Defense Blog:

Brazilian railroaded and abused by US Justice System

I am a friend of Jefferson de Souza and I am creating this blog upon his request and the first few posts will be from myself and are my own opinion as to his situation. Jefferson's personal comments from prison will follow

and I will insure to announce when you are seeing his own words. Firstly, I will state that neither myself or Jefferson are claiming that his actions in 1996 were wise or well thought out but the repercussions of his actions by the US Justice system since then have been inexcusable, criminal and ongoing.

We are asking for help of any sort to allow Jefferson to be transferred back to Brazil so that he can be near his only family members who he has not seen for over 20 years. Legal or political help would be greatly appreciated as well as donations for such help or his personal expenses such as communication with his family in Brazil. Moral support and casual penpals would also be of immense help for someone in his position. If you only want to write to slander or rant, please don't bother as he has heard it all and more of the same is simply disregarded and forgotten. We have learned long ago that the vast majority of regular citizens have no idea that the US Justice system is as corrupt as it really is and it becomes pointless to try to convince them individually. When they or their family member makes one mistake in life, that the US government doesn't like, they learn very quickly as to what they are up against and it is far from true "Justice". This justice system is a gigantic, self-perpetuating, money generating, business that protects its own actions at all costs. If you do not have the money to pay off the system by hiring your own insiders known as defense lawyers, you are finished as evidenced by the Feds 98% conviction rate.

Jefferson received a 26-year federal sentence based upon one of the most absurd legal cases that is so far from common sense and so full of underhanded corruption that a Hollywood movie producer would turn this story down.

Strap in and get ready to read a story that is beyond reality but is 100% true, provable, and ongoing.

Here is the very brief version of the US Justice Depts claims and case against a Venezuelan citizen named Richard Romero aka Brazilian Jefferson de Souza.

http://articles.chicagotribune.com/1997-06-13/news/9706130329_1_prosecutors-internet-conversations-computer

<http://law.justia.com/cases/federal/appellate-courts/F3/189/576/526671/>

This is the governments nonsense case that they deemed worthy of a 26-year sentence. Briefly, to accept this nonsense, you must believe that someone, anyone, is stupid enough to "kidnap" a teenage boy on a public bus and then make up some further scenario that you "believe" was going to "possibly" happen at some time in the future. You also have to believe that two days is enough time for someone to recover enough from a gang beating and rape, while in a locked "Protective Custody" cell, to coherently defend himself in a federal trial.

Here is the quote from the Chicago Tribune Newspaper:

"Romero, for his part, watched the proceedings through one eye, the other apparently injured during what a source at the federal confinement center where he is being held called an attack by other inmates.

The trial was delayed two days by U.S. District Judge Charles Kocoras, who has ordered attorneys not to discuss what officials at the Metropolitan Correctional Center in Chicago are describing only as "an incident."

Before the incident, Monday, Romero appeared healthy in court. On Thursday, out of the sight of jurors, he was brought into the courtroom in a wheelchair."

The files from this incident, as well as the medical records have since disappeared and no one has ever been accused or held responsible. Also missing in this Tribune report is the fact the Jefferson's first trial resulted in a mistrial when the jurors could not be unanimously convinced that Jefferson kidnapped a teenage boy on a public bus. After the feds failed in

the first trial, Jefferson's locked, protective custody, cell door was opened by guards, in the middle of the night, on the night before his second trial and a group of thugs were allowed to beat and rape him. None of the guards or attackers were ever identified or charged. Jefferson went into a federal courtroom in a wheelchair, that was hidden from the jury, while under heavy pain medication and was convicted and sentenced to a 26-year sentence with almost no defense case given. This is what the US calls "Justice" and preaches to the rest of the world about.

This is my personal overview of what I can determine has occurred based on years of discussions with Jefferson and my own internet investigations: In the late 1980s while investigating paranormal claims and alternate religions, the Brazilian UFO researcher Jefferson de Souza got involved with several groups including the Scientologists. Many of these groups and governments in various countries would hire Jefferson to do investigations, give speeches about his experiences around the world, try to hack government agencies for UFO information, etc. On several occasions while in the US at paranormal conferences, etc. Jefferson successfully hacked into NASA and other government agencies UFO files and he was warned off by the government for these activities. This was an early stage of the internet and hacking was not well defended and the databases that he was copying while being highly classified were not heavily protected. Upon being warned off several times by the feds, Jefferson turned more and more to the paranormal and religious groups to get him back and forth into the US and Europe. These groups had their own agendas and contacts in the country and in return for Jefferson's expenses, computers, and identities, he would provide them with the information that they were interested in. In 1995 Jefferson was provided with a valid Venezuelan military officers passport that had Jefferson's photo and fingerprint added to it. That is how the Brazilian Jefferson de Souza became the Venezuelan Richard (Ricardo) Romero. Richard Romero then came to Florida via a Canadian border crossing and delved back into his UFO/Paranormal investigations. While in

Florida, Jefferson performed various services for the groups who sent him to the US but mostly, he simply was conducting his own researches while traveling to conferences, etc. At one of the paranormal conferences, Jefferson met a family of faith healers from Des Moines and he eventually visited them there and lived with them for a while.

These people had their own issues going on as they had ongoing immigration issues and were running their own child porn import program from the Philippines. None of them worked and their only source of income was their "faith healing." All of these people would eventually be used by the feds to testify against Jefferson in exchange for all of the possible charges against them being forgiven. Every witness against Jefferson gave testimony that blamed him for everything illegal and cleared themselves completely no matter how illogical their claims were.

According to the above listed court transcript, this Filipino family of traveling faith healers let a newly met man from Florida live in their Des Moines basement because he had magic powers and could solve all of their problems with a computer? Really? The five trash bags full of Filipino child porn found in their basement came from this magic man on the computer and not from their own connections to the Philippines? Really? A group of faith healers with immigration problems and no jobs were buying a house and paying their bills but had nothing to do with the bags and bags of child porn that they themselves burned? Really? This group is one of the star witnesses for the feds and none of this group was ever charged.

Now we come to the teenage boy who was kidnapped on a public bus after chatting about UFOs on the internet. Once again, it is completely beyond belief that a teenage boy could be kidnapped on a Greyhound bus full of people but that is what Jefferson is convicted and serving a 26-year sentence for. The entire case as it is laid out and as it reads on the link provided seems more based on people's imaginations than any real actions. It is all about what the federal witnesses think might have happened at some future time and their opinions about other cases and instances.

Now we easily see how the Feds lost the first trial and why they needed a heavily doped up and injured defendant for the second one.

D. Ray James Correctional Facility in Georgia



Letter to You (as a Reader of this Book) From Jefferson Souza

Jefferson Souza – A Message from the Frontline:



The Real Jefferson Souza

Living an interesting life is a precondition to being an interesting person. I can say that my life is everything but too weary with tedious dullness. In other words – I live on adrenaline!

Six thousand and eighty-five days or so – the time I suffer from a legal condition known as “freedom impairment” meaning I am a U.S. Federal Prisoner, in nice dandy words: I am in prison! Redundant, no?

See, most people are like cattle. The cattle handler tells the cattle where to go, where and when to eat, and especially when to eat. And cattle do what cattle does. They accept the

handler’s words as fact because these words are supposed to be good as facts, regardless if they were truth or not.

Most cattle are content living like that. Once in a while there is a bull that questions the handlers’ words and even challenges the status quo. Well, yours truly here is the proverbial bull from this lore. I dare to question the handler’s words and went off their designated path to find a route that would lead me to answers, not more bull-stool. (pardon the pun).

The old saying of “be careful for what you wish for, because you might get it” is more fact than not. I’ve found out lots of stuff and paid the price for getting it – Lost my name, my family, my citizenship, my past and my freedom. Boo-haha. Well so what? It comes with the territory. One knows that by playing with fire one always could end up burned, so no regrets!

The B.S. they locked me up for, with a twenty-four-year sentence only came after I refused to sign a plea agreement on my fabricated charges and went on two trials – one that ended up a mistrial and another that was a shameful railroading. Yeah, yeah, I know all convicts are always pleading innocence and blah-blah-blah.

Well this message isn’t about me – It’s about my work and what I’ve learned to make those darn cattle handlers so mad to the point to produce such B.S. that put me where I am now.

Enough about me, if you want to know more, go to my defense blog for the details because this page is about investigations into the outer-worlds and the aliens that reside there as well as here on our planet!

Let's get direct to the point – Extraterrestrial lifeforms do exist and that is all there is to it. Proof? It is out there! Just go back to look for it. It has two ways to do it – Sit comfortably at your desk and look for what you can find on the Internet. That would confuse you even more than you were before you started, or go face the real and present dangers of walking in the shadowy places where truth can be found. But be ready to pay the price. And it's not just money we are talking about here... So enough preambles here and let's get down to business.

There are three stages of scientific discovery:

1. First people deny that it is true.
2. Then, they deny that it is important.
3. Finally, they give credit to the wrong person.

Typical: The right-wing mainstream of scientists denounces the lack of credibility and reliability of contactees and the abductees, and the very few left wing bona fide scientists still defend science at its proper principles, and burn the fires of inquisition for it. Who cares about the truth?

The truth is that only people that lived the personal experience of being a contactee or abductee truly knows and understands the deep scars left on one's personality, mind, and even one's own soul. More than a burden, it becomes a responsibility that one must bear alone since most people aren't able to understand their unfathomable consequences. The lives touched by these outerworlders, changed so drastically by their interaction with them that they will never be the same again.

Of course there are bad apples among the barrel of contactees and abductees, but we must all pay for the wicked deeds of a few? A rhetorical question, of course. We all know that a good deed never goes unpunished and a bad deed never goes unrewarded. That's life, so be it.

The thing is that I must present yet another class of alien interaction between the usual contactees and abductees, the operative category. Sure, you get the occasional contact and even a seldom abduction, but the way it works is you get instructions for an operation and receive not only the means needed to perform your task but also the proper compensation for your living needs. Far-fetched? Well it is not a job you can apply for. They choose you for it – not so much for your skills – but due to the constant legacy of your bloodline.

All operatives are “generational conduits.” Not every “chosen one” succeeds on becoming an operative. Some people are just not cut out for this line of activities, regardless of their genetic continuity.

Training starts even before one realizes that they are indeed aliens, and when you do, only your performance will dictate your continuity. Otherwise it is “missing time/erased memories” for you. Boom! Automatic amnesia for you. So, I guess I'm still “workable”, since I can remember all these things. The prison time didn't stop the activities. One day I must talk to you about the wonders of a technique beyond remote viewing known as mnemonics – something like “remote existing.” The coolest thing!

Well, this introductory message was to warm up the trans dimensional core engines and to let me spread some data on things that transcend the space and time continuum. Get ready to go beyond the speed of thought.

Later we will talk about the S'hamariath (the ones that one day I knew to be Vegans from the Vega Star System – and boy, that was only the tip of a huge iceberg) and the little grey guys that are part of the so-called Jagarah Collective.

Signing off,

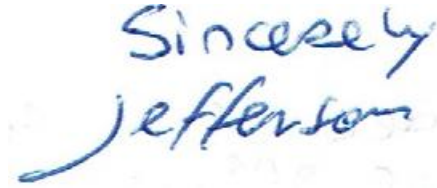

Sincerely
Jefferson

Example Edward Snowden knew about before he fled

Edward Snowden spoke about the case of Jefferson de Souza as an example why he would never trust the US Justice system to treat him fairly. Jefferson de Souza is the Brazilian UFO investigator who has been in a US Federal prison for 20 years under a false identity. Snowden found information about Federal cover ups in this case along with others like it in government databases.

Letters from the Real Jefferson Souza

You've just read a letter from Jefferson that was written to you. Look for more of these that we will get to you in the future. Now below are letters that Jefferson wrote to me. I've pulled out the parts that I felt would be of most interest to you and printed them here, so if it seems rather choppy, that is why. Jefferson tends to write rather lengthy handwritten letters. And remember, English is not his first language, it's probably more like his third or fourth and I don't want to edit any of it because this is Jefferson and editing would take away from it.

These were mailed to me from his secret underground bunker (supplied by, and all expenses provided for by the U.S. Government) hidden somewhere in the hills of Georgia.

Letter from Jefferson Souza on 9/15/15

Dear Gil,

Well, I think you've done a terrific job on keeping the Blue Planet Project in the loop as you've been doing.

See, there's a lot to tell from my escapades on DARPA (Defense Advanced Research Projects Agency) at Arlington, in your good state of Virginia. They don't have the data-vault on EBEs there. It was like a way to find clues on where the good stuff was.

In the 1980's only Arpanet was running under public view and the famous Rand Corporation was still tunneling the undergrounds of Dugway Proving Grounds in Utah. (Dugway can give a rundown to Area 51 anytime of the day, my friend.)

But, on the files at Arpanet was an interesting passage on "retro-engineering" on what they called "Nanofoam", a very interesting substance bases on Beryllium and some other metal they never have seen before – like a sort of metallic gel substance. It would use gravitonic fields fed by electromagnetic pulses and could produce chairs, tables, or whatever furniture one liked to create. And when one didn't need it anymore it went back to a gooey gel-like puddle condensed on the shape of a cube.

Well, this nanofoam came from a crash site of an "unknown space transporter in the Bahamas near where AUTECH now has their base on the Andros Island. Still a lot more! The things I've learned Gil... And what about our dear National Security Agency/Central Security Service at Ft. Mead, Maryland?

The ultimate high tech to preserve data: "Memory Crystals" Based on data of a salvage operation over a "crashed" spacefaring small vessel over Piedmont Plateau (East of the Appalachians between SE New York and NE Alabama. Refractive indentations got petabytes of data on... self-repairable polymers! And that was the 80's, a time for floppy disks and other prehistoric computer peripherals.

I never used an ID for G8 clearance because the model you've shown was not available yet in 1996. They had a similar model then, not with the encrypted security chip on top right and the holographic photo of the user on the left. But that's cool.





You need the ID to enter certain security areas at Arlington and Ft. Mead but you only could go so far. The elevator stopped on the bottom at subbasement five and all the good stuff was on the bottom at subbasement twelve. You need another GS card called UMBRA (a black one) to access the lower levels, or you could do as I did, take a black box and go “phreaking”, get access to the network, drop a worm (the “werewolves” are the better, in my humble opinion) and wait till things calm (meaning you must have a schedule of activities and a location map so you know where to go to stay put meanwhile the worm gets on the back of the servers. No big deal.)

Those were the glorious times, Gil. Before the Internet got infested by kids with zits that really think they are able to get into this game from a lousy desktop. If life was only that simple...

To go where I went one needed lots of contacts, cunning, a need for speed, good social engineering skills, access to certain alien tech (this story is for another time), a game face and lots of guts and luck! About 90% luck would help a lot!

I made serious enemies out there. The great invisible government, the greedy Scientologists, a bunch of wacky people called the HRM (Human Resistance Movement – they believe that all aliens are evil (or should I say “ee-veel” as their leader used to say, General Redneck, as I call him) and, of course, the Feds.

So are the Feds part of the Invisible Government? Nope. There are the Spooks – the Feds – and the Shadows (The invisible government, two dangerous groups and equally bad, both.

So why didn't they “erase me”? Kind of put me under six feet down? They've done worse! They stole my identity, stripped me from my country, my past, my life. Then created a B.S. Federal case and lost me within the system without any means to prove that I am me, not the persona they created as me. And that Gil is a fate worse than death.

Took me 19 years to get my resources back on track and I most of this to my friend J.C. He believed on me and went to investigate things by himself. Soon the web of lies the Feds created fell apart from deep scrutiny. Now the Brazilian Embassy is on my side. I may get a Presidential Pardon by what they call “clemency law.”

A new generation of Shadow Government lurks in the dark. The Feds lost their edge now that the shadows are on a turning point. Besides, they aren't as powerful now as they used to be before.

If they go after me for disclosing above Umber Clearance information I would say to them: “So, you do confirm the full existence of the Aramis Program and the ADR database, no? I don't believe they can do that. (The Code Aramis III and ADR3-24SM classification as carried by your Blue Planet Project Book.)

Not even Obama knows what some of these government entities have been doing for the last 60 years or so.

Besides, only three of them took the serum and two of them are over 100 years old even if they are still looking like they are in their 60's. The younger of them is in his 90's for sure, but looking in his 50's. Of course alien DNA can do these things to you... They had the nerve to pass as their own children to avoid unwelcome questions about their age and their unusual healthy appearance. This is a long story my friend.

I faced starfarers eye to eye. I've seen the wondrous, the fantastic, and the horrendous. I've sweat tears and blood on my face. I've lost everything anyone would hold dearest, and looked into the abyss and it looked back at me.

I've been 20 years incarcerated. Prior to that six years moving between continents in a lethal game of hide and seek. It's the stuff of movies or perhaps even comic books. But it was, it is real, Gil! That's my life – the things I've found, the things I've lost, and the horrors and marvels in-between! I've been silenced for too long... I need to speak to the World!

So, how I got my information? Just from the government? And do you think the government knows that much about the starfarers? They only know what the aliens allow them to know. And what I know I've learned from other aliens. You might say I am part of their plans... the Vegans. I've learned that the Vega Star System is not even their home world. Vega system is merely outposts on the order of a vast territory. The aliens are the S'hamariath, a group of civilizations united on a guild for the sake of a proper word. And there are a bunch of other groups, federations, swarms, collectives, confederacies, you name it.

It's so much to tell – Over 150 civilizations divided into subgroups and Roque batches. None of them has autonomy on Earth. Earth is a sanctuary world. One of the few the so-called consortium of mega-powers that protect preservation planets, like ours, and controls it.

But not because they are selfless. They aren't exactly selfish, but there's an agenda behind all this – the nature of the human soul. Nothing to do with theology or new age. Has to do with the ultimate evolution. We'll take a look at that at another time.

By the way, originally the Blue Planet Project was not meant to be a book, it was the title on the folder containing my field notes. I was thinking of writing a book about it but things happened and I vanished for 26 years. Glad someone followed up on it and created the book. Like an old friend used to say: "Black holes happen you know!"

Gil, you've done a terrific job with the books, I'm grateful to you for keeping the torch lighted. You're my voice out there!

And there's the story of my life, from the south of Brazil to the World, moving among continents, making friends and foes and lots of waves. 2016 will be my return to the free world.

Sincerely
Jefferson

Letter from Jefferson Souza on 9/30/15

Dear Gil,

I am beyond justifying why I am incarcerated when I have a defense website out there with huge worldly traffic and people crying out loud about the injustices done to me. The difference between one that is accused of similar crimes (and even falsely convicted of) and an “ethical hacker” is the knowledge he or she has about certain matters beyond national security and the ability to keep powerful allies as a useful “ace-in-the-sleeve” that guarantees you will not be “suicided” or “accidented”. And for the last twenty years I’ve proved literally that “ethical hacker” isn’t a myth, since I am still here against all odds. Of course I was roughshod, but for the count, I proved to be rougher than them. I might bend, but I didn’t break. Hence yours truly is writing this letter to you now. Besides, the difference between successful people and others is how long they spend time feeling sorry for themselves. I have no time for sorrowfulness. I’ve kept my network fully operational to keep me posted and I have my own secrets on how I might obtain the unobtainable. Our growth as an evolutionating species depends not on how many experiences we can devour, but how many we can fully digest. I come to leave my mark on the World!

Regarding the “Blue Planet Project Lost Chapters Book:” The medical doctor that had reviewed my information on “Alien Pharmacology for Humans” regarded them as “Star Trek Drugs” and he wouldn’t be wrong on that.

More info on the Lost Chapters book can be found here:

<http://www.blue-planet-project.com/lost-chapters.html>

You know the story of Star Trek? Well, I never imagined myself that a sci-fi show would have the connections with true alien affairs as I’ve come to discover later on.

Gene Roddenberry, the creator of the show, was said to be a man way ahead of his time. And he was. What people don’t know was that Roddenberry regarded the alien matter very seriously, he himself was a contactee! Remember that all things like sci-fi props at that time became the reality of today.

Their communicators turn into cell phones. Their phaser beams into the scalar weapons. Even teleportation was already done by M.I.T. of one laser beam teleported successfully from one lab to another. The replicators became the 3-D printers and the holodeck the immense gravitational/electromagnetic field virtual reality environments of the NSA, DIA, and the U.S. Space Command.

As the U.S. Space Command is the equivalent of their Star Fleet (that isn’t interstellar yet but surely is full-functioning orbital.) Even Star Trek’s Federation was based on the concept of the consortium.

Do you know who produced the original Star Trek series? Desilu Productions, Desi Arnaz and Lucille Ball. So I will follow the tradition of a sci-fi show supposed to be fake science, that indeed was built on real alien knowledge. And so many other shows were being used for preemptive disclosure (like “Close Encounters of the Third Kind” on which Prof. J. Allen Hynek appeared in it as an extra and was the French researcher Jacques Valle’ as the main government character, serving the contactee himself.)

The drug information in the Lost Chapters book is the real deal and was taken somehow by someone somewhere over at the Los Alamos underground site. And yes, it was mentioned several times on Star Trek shows, but also given to pharmaceutical industries on the end of 1950's after their "acquiring it." Star Trek aired in mid-1960's.

You would be amazed by the quantity of sci-fi books, movies, TV shows, and even comic books that are based on a reality involving aliens that were mingled in those shows. So, if someone tried to be a whistleblower, this would make sure that no one would give credit to him or her since it was already publically labeled as "fantasy." Devious brilliant people these Feds. Besides, as I've said, people do not think by themselves.

I never mentioned that before to avoid being sued by the Roddenberry family that, even while enjoying the money from Star Trek royalties, do not enjoy controversies about the late Gene. Oh, well.

But think about it, the first space shuttle was to be called the USS Arizona, but was changed immediately to USS Enterprise! And Roddenberry, when he died, was the first man ever to have his ashes thrown into space by a space shuttle! Coincidences? You tell me.

A show that just lasted two or three seasons became a legacy that conquered time – half a century and counting and spawned several spinoffs of Star Trek: The Next Generation, Star Trek: Deep Space Nine, Star Trek: Voyager, and Star Trek: Enterprise. And also the ongoing movies that always find a way to be Star Trek reborns.

Look to the last two incarnations of Star Trek movies – became box office hits twice! So I'm proud of Blue Planet Project's link to Star Trek! All controversies are good, right?

Gil, my next project is going to be an international initiative and virtual community to be known as "EARTH STATION SEVEN." So far I have a ground-base to establish it in Brazil with follow-ups in Germany and the Philippines. I'm expecting to return to Brazil by mid-2016. There will be volunteers, Internet researchers, and moderators. Earth Station Seven will be dealing with alien-related affairs, paranormal, cryptozoology, and ecological matters.

By the way, NSA's 20 trillion transactions "acquired" from phone calls and emails could only be possible on secret quantum computers. It's the dawn of the neoneuron gel pack circuitry and the fall of the integrated circuits and motherboards!

And now DARPA's Project Looking Glass is developing a trans-dimensional window to the multiverse!

Will the day come when people are jailed for meddling in Alien Affairs? By doing that they would have to admit, publically, the existence of extraterrestrials among us. And do you think the Government is ready to do that? Nope, they aren't.

Bit by bit the truth is getting out there. So, on top of all that, the X-Files have returned – Do you remember how popular they were? We'll if aliens always were a hot topic, soon they will become even hotter, and there's not much the Government can do about it!

Sincerely
Jefferson

Letter from Jefferson Souza on 10/26/15

Dear Gil,

Regarding the mention of Great Britain:

I have been corresponding with The former D.O.D. official, Nick Pope since my time at the Ft. Devon's B.O.P. Prison Hospital and he sent me some of his books. I had some memorable moments in the United Kingdom. I must write a book on my undertakings there.

The debunkers of the Blue Planet Project can say what they want but none of them (save my dear departed friend Col. Wendelle Stevens, Bill Cooper and a few others like Bob Lazar and John Lear, and others) tried to openly put the truth on the public. All have been demonized, as well. The poor late Col. Stevens even went to jail himself, as I am right now, because of the wrathful vengeance of the powers-that-be.

When others were "erased" I and very few others, covered our backs to make it impossible for them to resort to lethal options, or the consequences of such harsh and unwise actions would provoke a full open knowledge with proof of their wicked doings with and on the behalf of outerworlders.

What proof is this you would ask? Well, if I would tell you I would lose the ace-in-the-sleeve that kept me alive for all these years and the many years to come. My discretion and secrecy is my bargain with the devil to be able to continue to exist. Survival is a powerful motivator for secrecy.

They tried to suppress the Blue Planet Project in its beginning, but failed.

Sincerely
Jefferson

Letter from Jefferson Souza on 10/19/15

Gil,

Believe me, when you resurrected the Blue Planet Project and my name, it was not a joy and happiness to the shadows (invisible government) and the Feds (the official government). They were sure the Blue Planet Project was put to rest for good. And they thanked their fate that no one actually, truly understood the potential that the Blue Planet Project could unleash.

It revealed too much of what is supposed to be truly secret. And, even when people accused it of being a hoax and such, they secretly pray that most people think of it as such. The data is far too revealing, and far from anything ever published before on this subject.

Even the UFOlogists here in the U.S. are afraid of the Blue Planet Project because of the Feds.

But after twenty years, a lot changed Gil. A new generation on inner-power came into the game and even liked that the truth started to be leaked by the Blue Planet Project and



from my other notebooks and started to be revealed to other authors out there.

Things are changing very fast and the powers-that-be know it.

These are the glyphs that appear on the Blue Planet project cover:



Since they have puzzled a number of people, let me explain. They read: "Planet Blue" and the anterior glyphs say something like: "Plan, Design, Layout, Proposal, Profuse (or Plentiful), In other words: "Profuse Blue Planet Project" on which I only kept the Blue Planet Project part.

As to why Amazon.com temporarily pulled the plug on your listing of the Blue Planet Project, it was due to the hasty response of the powers-that-be on having their secrets thrown into the public light just like that.

It was about February 2013 that I got a visit by a "spook" posing as an agent of the National Security Agency asking why I was **meddling with stinging wasps again**.

(Note: "meddling with stinging wasps again" is most likely referring to the listing of a printed version of the Blue Planet Project by someone who didn't want to be identified. It was first listed in February 2013 and dropped several months later. It was in September 2013 that I (Gil) came out with a printed version based on the original version and listed it on Amazon.com till it was banned by Amazon in December then it was allowed to be relisted a few months later.) If the Blue Planet

Project is just a hoax, as some folks have claimed, why would the government be so upset by it?

And it was when I was moved from Ft. Devon, MA to D. Ray James in Georgia from a full-fledged B.O.P. installation to a private GEO group Immigration Facility, with a Federal contract, that I was told to be ready for some good news. That came in 2014. Part of the Clemency Act Initiative that Pres. Obama would give me a Presidential Pardon. I received the paperwork from the officials, now I'm waiting for it to go into effect.

The so-called "Yellow Book" referred to in the Blue Planet Project, is **not** a printed book. It is the code name given to the reports of personal data from aliens in captivity. Also, I knew Bill Cooper and even Bill English, both sacrificial lambs for the powers-that-be. Bill Coopers "Behold the Pale Horse had a lot of info that was very important, but he should never have gone up against the IRS. May his poor soul rest in peace.

I met Bill Cooper in Ft. Lauderdale, at a meeting with a "deep throat." The deep throat didn't make it either. One can't be nosing around Andros Island's AUTEC without insurance. Those people are nasty as are the ones at Utah's Dugway Proving Grounds.

*Sincerely
Jefferson*

The new book "Alien Underground Bases" has a chapter on Dugway Proving Grounds, you can check it out at:

<http://www.blue-planet-project.com/alien-underground-bases-book.html>

Letter from Jefferson Souza on 11/1/15

Gil,

Greetings again. I'll soon be explaining how I came to meet the S'hamariath (Vegans) and how I got some of the data I've "acquired" from places that should not have been "officially existent" and my beef with the powerful Church of Scientology in relation to mind control and outerworlders.

Just to let you know, David Miscavige is the supreme leader of the "Church", and the Sea Organization, the private army of these fiends. You need to discover the truth about the happenings in Clearwater, FL, the Scientology's town and the secrets of the Golden Base, their desert retreat/stronghold over the vast scrubland East of Los Angeles and West of Palm Springs, near the town of Hemet, there you shall find a literally top-secret facility monitored constantly by security and attack dogs and electrical fences to protect the heart of the Scientology Empire.

The thing is that no one knows who or what was behind the whims of the late sci-fi writer and founder of the Church of Scientology, Lafayette Ronald Hubbard. I intend to write a

book about my findings about it. I know them because I was a victim of them. And as far-fetched as it might seem, these people are deadly and as vile as they come. They are everything but a bunch of wackos. They are a well-organized structure exceeding in intelligence and tactical programs with a budget of billions. But they do have an enormous Achilles Heel flaw that happens to be of my knowledge, fortunately, I am out of their reach. I can denounce them, but just up to a point. To exceed this limit would be disastrous for me as well as them. I only can tell you that aliens are involved in this issue. I can tell the truth about Hubbard and Scientology but I can't tell the details nor the outcome of it.

I have so much more to reveal about secret government programs. And I'm not worried about the reactions of the DARPA and NSA because Feds are extremely predictable. But even they know that it is better to ignore the issue than having to explain their "wet works program" (elimination) to the public view. Americans killing foreigners just because they know too much may be acceptable, but Americans murdering Americans for the same reason is devastating. And having names, dates, places, all the details is proof and always a good health insurance policy. They leave me alone; I leave them alone. So **why accept calmly 20 something years of jail**, reputation ruined, and loss of identity and past? My life is worth way more than that. Besides, even in prison I never stop doing my job. Let them think they are victorious.

Regarding **the Anunnaki**: They are relevant because they had a small part to do with our making. But they are not our creators! They served their purpose by serving the Creator in adjusting the last details. They were mere living tools used by our creator. Or so, the Babylon's truly believed in such things, even though they were polytheists. Later I will let you in on what I have learned from these starfarers and what data we consider as veracious in my little circle of dedicated researchers.

Accessing other intelligences through molecular consciousness is a lot easier than you may realize. Molecules of living organisms are in a constant state of communication, sharing and transmitting information both as at the intracellular level as well as across vast distances – data translational control, it is called the basic neurobiological principles of sending and signaling data acquisition. Once dealing with outerworlders, something of them gets in you!

Sincerely
Jefferson

Letter from Jefferson Souza on 11/11/15

Gil,

I just want everyone to know that I am no saint, who is? I've made mistakes. I've walked the path of the shades of gray. I have chosen to stand alone and face bogus charges rather than accept their offer of a shorter sentence to admit to an infamy of lies! The torch was taken by other brave souls and the message is still spreading out to the World! Aliens are definitely real! People look for them in the skies and interview witnesses, but the truth is the aliens walk among us, disguised as us and unopposed by most people, but not from me!

I already knew something about the outerworlders since my boyhood, by my experiences with them.

The Blue Planet Project was **made from my field notes** of what I had learned and even things I could not quite come to understand. And meanwhile I was waiting between assignments, I kept busy recording what I could remember.

Nope, I'm not a scientist and I never worked (willingly) for the U.S. Government.

Clearance Credentials were given to me by more powerful sources than the Feds. The **relations between aliens and humans** are much more complex than one can imagine. The money that kept me moving came in cash, no financial trails left behind.

It was claimed that the Blue Planet Project was written by a government scientist who leaked the information. Actually there **never was a single scientist** leaking things out there. There were several! Some of them ended up erased (killed) and others were put in stasis freezers (don't even ask) and others were fallen by unfortunate accidents.

My wonderful late friend Lt. Colonel Wendelle C. Stevens and his good friend sergeant Major (ret.) Robert O. Dean knew their share of what was going on, up to a point.

I lived in Tucson, AZ when I and Col. Stevens went on our journey to the **Panamint Mountain Region** in California to witness the display coming from its underground tunnel complex. Shame the overseers never allowed us photograph those events.

We've learned a lot. We have seen a lot. We have seen good friends die like "Behold the Pale Horse" author **William Cooper**, the persecution of Bill English. Even poor Col. Stevens experienced the "prison treatment."

Now onto the "UMMO" subject. Things aren't as they seem. The **UMMO** was a complex subject with many fronts. Of course there were starfarers from Lumma (or wolf 424), but there were also human factions and the other part of a project called MONARCH. It led to the MK Initiative.

The ominous project MK had several subdivisions as **MK-Ultra** or **MK-Naomi**, **MK-NH** (New Horizons) also used the devious technologies known as **RHIC** (Radio Hypnotic Implantation Control) and **EDOM** (Electronic Dissolution of Memory)

Regular people were chosen (regardless of their awareness or not) to act as living drones writing the UMMO papers to create disinformation on the subject.

The OMAE UMMS (People of Umma) started their own attempt to make contact (Against the regulations of alien overseers) as they were being dealt with by alien controllers, their allied North Americans would disrupt any attempts of UMMO to build a true human network, as they've already started with some human subjects.

It was an ugly deal also there were intendent Lumas within this mess. Ribers didn't want to accept that, and continuously defended his position of the Umma being absolutely alien, all the way. He was right, but only in part. Humans had a great deal in this, as well, due to their own reasons. But nevertheless, it was an alien affair in its roots of course. 1991 and in Tucson I was getting ready for the UFO Conference titled "Extraterrestrials are Visiting Earth" With one day till its opening, I was still working on my notes for the "Blue Planet Project." I didn't need to be precise on details since it was made to aid me to not forget what I've learned.

Sgt. Major Dean was kind of impressed with the contents of the Blue Planet Project' notes. Well, they were just notes. He confirmed quite a of the things in it. And a lot more he had never heard of before. Good, it was supposed to be like that.

There are so many things that I never had the opportunity to do with the Blue Planet Project notebooks. It amazes me that even now outerworlders are still an issue regarding their existence! Today the majority of humankind still proclaims that they are the only source of life in the whole Universe. Even when they secretly hope that someone or something is also out there. But within this denial of existence of outerworlder life forms, there are programs officially sanctioned (or otherwise) still seeking for what they know is unavoidable and absolute – Extraterrestrial lifeforms are real!

And they are not just about to reveal themselves to the public yet. There are dangerous and deadly variables, civilian and military, that would make them not want to reckon with, otherwise, there would be consequences, of course. Hence the persistent denial of it. Because what you don't know is out of your mind. But for the rare people that do know, those privileged ones know of wonders and horrors. Because among the morsels of the elsewhere, also come the weight of knowing the threat that would change our lives forever when it comes.

Humankind lives on innocence and of the disinformed and even the ones that suspect, but do not know it for sure. Sleep easy without the knowledge of the power plays that the shadowy inner-governments play against themselves and these offworlders...with humankind amid it all.

Extraterrestrial (and related outerworlders) biological entities do exist and are visiting Earth, and have been even before human beings came to be. Do you want proof of it? Reach out beyond the closed protective walls of the skeptics and above the naiveté of the believers and really look without any prejudice or personal gain and you will find that any genome research will tell that there is much more about the human genome that they dare not reveal!

Cannot reveal because of its inconceivable relations between humankind and the natural selection of life on Earth and the incontrovertible knowledge of genetically manipulation upon our genotype mold. Who would dare to admit that publically and face the scorn from it? People would rather take the way of the ostrich and hide their head underground until what bothers them goes away. But if it isn't so, well, we can imagine the outcome of it, no?

Then came the **Blue Planet Project notebooks** that were turned into the book. So what is the reason for the book? Why? – To share knowledge (but up to a point, there are

limits for it). Because if I went ahead and revealed everything, I would not only be a fool, but I would be a targeted fool. So, I'll say it without really saying.

Take Blue Planet Project as you please. A story, a legend, a joke, whatever makes you happy. It's all "off the record" here! Fiction? You'll be the judge of it. And certainly, if one investigates these stories, they would surely surprise you. So, skeptics, hold your "swords of truth" and believers, don't just believe, but go look for yourselves and make sense (or not) of what you might find.

I'll not deny or confirm any of what I've written, officially. But unofficially, I'll say that where there is smoke, there is fire, somewhere.



Wendelle Stevens at the International UFO Conference

I think back to those times with Wendelle... seated there at the conference in Tucson and listening to all those things people said, it amazes you how close to the truth some people were and how far from it others also were. But what was astonishing was knowing that among us humans, the very aliens are working amid us, looking and acting just like us. And no one noticing those outerworlders at all. But with the human intelligence's interloper agents moving about in their usual fashion as well.

From knowledgeable experts to willing voices in the field of research in extraterrestrial entities, we are all drawing maps in the dark, knowing close to nothing about the very nature of our research. As we all try desperately to find some sense amid the chaos of **alleged alien knowledge**, we count only with the data provided by meager scientific findings, but mostly counting on claims of abductees. No one is doubting their veracity (at least in most of the cases) but, on their personal interpretation of their experience, especially concerning any kind of information obtained from the offworlders.

Eventually we need to get into my contacts with the Vegans which started when I was a child back in Brazil. This alien, which referred to itself as "One" told me how we were having our encounters:

Most humans do not understand the **nature of the dream state**. There are dreams that are mnemonic and/or psychogenic or psychosomatic. But there are also dreams that involve transconsciousness of many kinds. It was the case of remote viewing and its successor mnemonautics. Mine was a form of virtual consciousness transportation in which it appeared as some sort of dream, but it was a real “virtual” experience.

The Roma, the people called erroneously “Gypsies,” are of great interest to the International intelligence communities working on black budget projects related to paranormal events that could be used as a means to gain knowledge and/or connection in top classified agendas.

The conceptual idea of remote viewing comes from chronicled perceptions perceived as “**lucid dreams**” going back thousands of years. (let’s use the epic of Gilgamesh, from 4700 years past and Roman emperor Augustus’ mandatory citizens dream recordings from 14 A.D. for instance, as examples.)

As in modern times, Sigmund Freud began to wonder about the significance of the dreams. It was his student, Carl Jung, that gave dreams a relevance that they never had before.

The crucial point of hypnotic phase, the very borderline between sleep and awareness, is a Launchpad to remote viewers. Dreams are much more than we give them credit for. In 1987, Los Alamos Laboratory did research on magnetoencephalography in conjunction with the ORD (Office of Research and Development) and OSI (Office of Strategic Intelligence) decided to dwell on the inner-workings of the human consciousness and its viability of use for intelligence operations purposes.

Using devices like the **SQUID** (Supercomputing Quantum Interference Device) on certain human subjects’ psionic capabilities. They used seven channels of frequency connections in order to attempt to enhance mental abilities in them. (A new variant on this subject is the **Project Looking Glass**, phase V which uses over 150 channels with multi-frequencies.

Human subjects, volunteers or not, were an extremely sensitive topic when using governmental budgets for such experimentation, so these researchers kept it “under the table”. – No records whatsoever should appear.

The so-called “Proxmire Effect,” where the fear that certain U.S. Government research contracts would be claimed to be ill-founded, if involved in certain unusual and/or suspected activities and certainly would be held up to scorn leading to a revision of the validity of such projects,

Project MK (mind killer), MK-ULTRA and MK-NAOMI are examples. Most of them used the awful RHIC (Remote Hypnotic Interface Control) and EDOM (Electronic Dissolution of Memory – also known as “Missing Time”) technologies that caused damage to the human brain.

Since the ROMA studies, the S.R.I. International Program openly worked with projects RAPT, GRILL FLAME, and GATEWAY. They were the precursors of PROJECT STARGATE remote viewing.

The next evolutionary step of remote viewing is mnemonautics, transdimensional memory retrieving for mind traveling over the multiverse. There are “made” mnemoauts and there are also natural ones. Both are rare.

I have come across many secrets even though government agencies feel that their secrets are protected in their high-tech digital fortresses, and they may be, but it is impossible to protect the secrets locked away in their employee's minds!

The mission of protecting secrets is now on a higher plateau, consider that secrets may be leaked because people dream! Human minds become interconnected over the sleep-stream. Once one travels this multidimensional continuous flow of distinct minds, once in lucid dreaming one is in reality accessing information from very distinctive sources, human and non-human.

As the spacefarers cannot connect to sleep-stream as good as humankind can, they are amazed and afraid of our innate psionic capabilities.

Outerworlders do possess psionic capabilities (as with telepathy and such) since it merely involves transmission and retrieval of bio-electromagnetic impulses generated by their neural cortexes on something akin to radio frequencies (which are certainly not radiofrequencies). But the very rare aliens reaching the sleep-stream cannot maintain mental integrity, nor complex sentience (as humans naturally can) for long. And the offworlders can only do that by using technologies to increase their limited range of bio-frequencies.

This applies to all, but lifeforms that are non-physical, because they are made of "living energy" and don't even require the use of technology for anything. That is what made all of them to fall under a single universal rule of contact.

That's all for now,

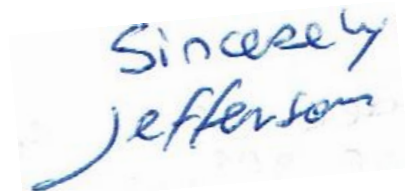
A handwritten signature in blue ink that reads "Sincerely Jefferson". The word "Sincerely" is written on the top line and "Jefferson" is written on the line below it. The signature is written in a cursive, slightly slanted style.



Crash Landings of Anomalous Aircraft and Devices

By Jefferson Souza

Several crashed anomalous vessels of unknown precedence are said to be of extraterrestrial origin. Such objects and vehicles are also reported as having passengers on them as well. From these events certain knowledge is believed to have been acquired from them.

Everything we THINK we know about alien life forms came from leaks of the black budget projects and what people heard from witnesses of certain events, besides what contactees and abductees tell us. All nice and neat and fitting an obvious pattern. But what if **people were deceived** by a psychosocial strategy that takes us from the right path and was designed to mislead us to a totally distinct one well away from the factual things?

Because in our eagerness in trying to understand the strangeness that seemed non-understandable, we chose to believe on the simple thing that SEEMED to be backed up by the information given by the outerworlders themselves.

Do these highly advanced beings really allow their technologies to simply fall into the hands of mercurial, passionate people such as humankind? Or allow the secrets of their genetic make-up to be learned and perhaps even manipulated, once in human hands? Do you allow children to play with an atomic bomb or extremely dangerous biochemical hazards?

Even starfarers are under the effects of entropy. But with advanced science also came advanced precautions. These alien sentient lifeforms did not journey only between star systems, but also between dimensions, as well. And will not just crash here like a careless driver on a bad day.

The theory states that 99.9% of the "crashes" are STAGED. Only about 0.1% were regrettable accidents. But when those kind of crashes do happen, these groups of civilizations would do whatever has to be done in order to retrieve the crashed vessel or device and making sure it will be absolutely obliterated at molecular level. Why only this meager 0.1% of crashes? Because all the other 99.9% are provoked crashes. Each one of them is a carrier of some kind of TROJAN HORSE!

How come? The best way to infiltrate a highly-secured human facility is to let us bring the offworlders inside, willingly. The crashed vessels are nothing but ancient junk to their standards, but very advanced technology to us humans.

Even the aliens (dead and alive) found in the wreckage were nothing but fabricated biodrones. They will never risk the secrets of their genetic make-up to fall under human hands, because to know these species genes would give empowerment to us. The EBE amalgamations are nothing but chimeras made to confuse, not to inform.

The objectives of these charades are for them to be inside the facility. Very self-reliant and devious. Some form of nanites with yocto-capabilities (a yachto is a power of measurement of 10^{-24} that allows them to pass between molecules in small clusters and replicate once in anti-contained area. The nanites are hidden along the atomic structures of the atoms of the device and/or the molecules of genetic material of the EBEs.

Why not infiltrate from the outside if they can trespass atomic structures? Because they cannot pass through energy fields, a contained space, nor bond effectively with human atomic structures due to an incompatible field of molecular integrity.

More to say on this later.

*Sincerely
Jefferson*

SpacePort Under Death Valley

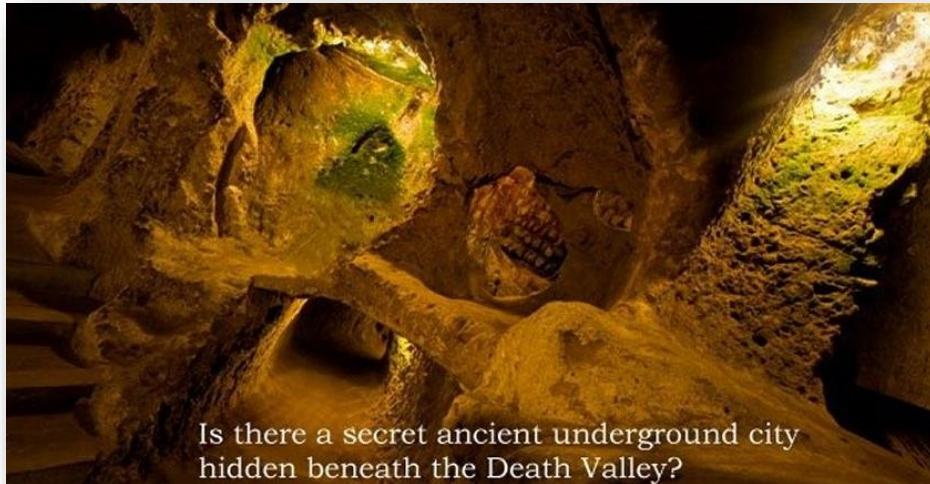

Is there a secret ancient underground city hidden beneath the Death Valley?

In one of his letters to me, Jefferson mentioned exploring caverns under the Panamint Mountains in Death Valley with his good friend, Wendelle Stevens, so I wanted to share this article with you to give you a little insight.

"One 'contactee', incidentally, has stated that a large 'space port' does in fact exist in a network of caverns deep below present-day Death Valley.

In reference to this we will quote from a 'synopsis' of the experiences of Brazilian 'contactee' Jefferson Souza, as it appeared in a catalog put out by the UFO LIBRARY in Studio City, CA. Many of the individuals referred to in this catalog, which offers taped interviews or lectures describing their encounters, are either 'contactees' who have had friendly encounters with the so-called 'Nordic' or human-like beings who pilot many of the 'alien' craft; or who have been 'abducted' by the more manipulating and predatory 'Gray' or 'saurian' entities. Quoting from their description of Mr. Souza's experiences:

Reaction to the first sighting of a UFO is unpredictable. Jeff Souza had his first contact in 1979 when he was only 13. The memory of it was tucked away in the recesses of his mind. Twenty alien contacts during the next 10 years never fully restored the image. But those years were filled with excitement that would result in one of the most inspirational stories of alien contact ever recorded.

The young Brazilian was possessed of intelligence and intuition. He studied and managed to complete one semester of medical school before giving up his formal education.

In contact with two races of extraterrestrials, Jefferson has met them in Brazil, Argentina and the United States. But where they occurred is unimportant when compared to the depth and cope of what he learned.

The gentle VEGANS and the business-like UMMITES taught Souza more than he could ever imagine about technology and life on all planets. He was transported aboard a spaceship by LIGHT (anti-gravity rays?) and taken to other planets and (other) parts of the world. On one such trip he suffered an unusual reaction - all his hair fell out. His watch broke at every contact.

Jeff Souza has been questioned by experts in the field of alien contact. He has been clinically regressed through hypnotism to the time of his first contact but the answers came only in Portuguese. At that age, Jefferson could not speak English. The details he has learned are awe inspiring. Answers to questions about time, space, matter, energy, life and spirituality easily rolled from his tongue. All prompted by the alien contacts of his past and present.

His interview and the recorded details of his many physical contacts PROVIDE HITHERTO UNKNOWN INFORMATION ABOUT SEVERAL ALIEN RACES INCLUDING THE MYSTERIOUS AND THREATENING GRAYS. FROM JEFFERSON SOUZA WE LEARN ABOUT THE SEVEN RACES (possibly humanoid and/or saurian), THE ALIEN NAME FOR EARTH, A SUBTERRANEAN SPACE STATION IN DEATH VALLEY AND IF AIDS MIGHT BE CURED BY ALIENS.

There is a final precaution from his contacts - we must all learn the lessons given to Jefferson Souza because we are destroying our planet and if we don't change, not even the friendly aliens will be able to save us.

We see here then a definite connection between the subterranea of the Death Valley region, which is reportedly inhabited by the neo-Grecian (?) Hav-musuv and the human societies of 'Vega' and 'Ummo', which as we shall see later on, according to other contactees, are "Federated" with other human colonies or civilizations in Tau Ceti, Epsilon Eridani, Alpha Centauri, the Pleiades and elsewhere.

Although Jefferson Souza claims to have encountered the Ummo People in landed craft, the Vegans are the ones who allowed him to travel on their craft most often. It was also the Vegans who showed him the MASSIVE basing complex below Death Valley, which contained chambers miles in diameter and numerous compartmentalized sectors which had been adapted to meet the gravitational, atmospheric and environmental needs of the various Federation world representatives who use the base as a way-station for their

operations on earth. Apparently the Hav-musuv's have been VERY BUSY for the last few thousand years, according to Souza's account.

In addition to the above, Souza learned of two other alien species that are in conflict to some extent with the humanoids with whom he maintained contact. One of these includes an "Insectoid" type race, while the other is reptilian. The latter consists of a tall, very reptilian-saurian appearing "master" race to which the shorter reptilian "Grays" are subservient. There are at least three types of "Grays", according to Souza: those that reproduce via egg-hatcheries, those that reproduce via cloning, and those that reproduce via polyembryony.

Secret Intelligence Files of Jefferson Souza



The following information was released by Jefferson Souza, a contactee who has had repeated encounters with the Vega Lyran's, who according to Souza are similar in appearance to the "dark skinned Orientals" of India. Souza also claims contacts with Scandinavian-appearing humans from Lumma or Wolf 424 [the 'Ummo' people]. Both cultures utilize a huge 'Federation' base located within a vast system of caverns deep beneath the Death Valley - Panamint Mts. region of California. In fact, several federation groups utilize the base according to Souza, which contains whole areas specifically

conditioned with the various gravitational, atmospheric and environmental conditions necessary to meet the needs of the various Federation visitors and dignitaries.

The Paihute Indians of the southwest U.S. claim that a Greek or Egyptian-like race first colonized the massive caverns within the Panamint Mts. thousands of years ago [one source claims the base was established around 2500 B.C., which is incidentally about 600 years following the beginnings of the rise of Egyptian intellectual culture] when Death Valley was part of an inland sea connected to the Pacific Ocean. When the sea dried up these people -- who were described as wearing flowing robes draped over one shoulder, head-bands holding back their long dark hair, and bronze-golden skin -- out of necessity began to develop their collective knowledge and intellect and soon afterwards began to construct "silvery flying canoes". At first these flying machines possessed wings, were relatively small, and flew with a dipping movement and a loud 'whirring' noise. As time passed the ships became wingless, grew larger in size, and flew ever more smoothly and silently. Eventually these people, the HAV-MUSUVS moved their civilization into still deeper caverns which they had discovered farther underground, and commenced to explore the nearby planets and eventually other star systems as their own technological explosion began to refine every aspect of their society.

These Hav-musuvS have apparently had interplanetary or interstellar travel for 3000-4000 years since they first developed their flying machines. Could they have been one of the many native-terrestrial "ancient astronaut" civilizations which apparently had colonized Lyra and other systems? The story of the Panamints was related by a Navaho Indian by the name of Oga-Make, who in turn heard it from an old Paihute medicine man.

What about Souza's reference to the Vegans, who are similar in appearance to East Indians? I believe that India is a major key to understanding our planet's lost history. The ancient Vedic texts speak of flying ships called "viminas" as well as nuclear technology which was utilized by the ancients there. Hinduism itself arrived in India as a result of the Pre-Nordic 'Aryan' invasion from the North [the Gobi region?]. Some researchers insist that the Mayas AND Egyptians were originally navigators from India, possibly explaining the similarity in architecture and their advances in medicine, astronomy, mathematics, and so on.

Swiss Ethno-archaeologist Yves Naud also quotes from ancient Indian texts which state that the leaders of ancient India later collaborated with secretive Grecian intellectual societies in the development of aerial ships. So then, the "Hav-musuvS" may have been representatives of any one of these cultures [Nordic-Aryans, East-Indians, Egyptians, Mayas, Greeks] or a combination of cultures. However, one thing is certain, only a VERY SMALL portion of the true history of planet earth, as of this writing, can be found in the standard historical textbooks.

Alien Involvement in Earth's Recent History

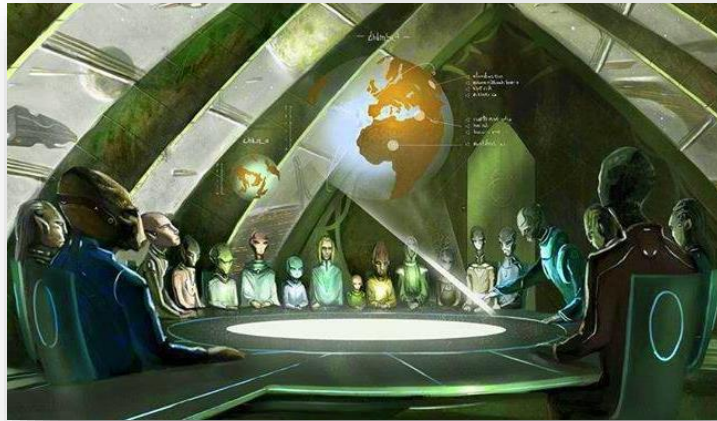

By Jefferson Souza

1934 -- The first 'deal' or interaction with the Grey entities occurred on July 11, 1934 on board a naval ship in Balboa. It was here that the agreement was initially made [between aliens and representatives of the 'Bavarian' Illuminati operating within U.S. Intelligence 'fraternities'] that let the greys proceed unhindered with the abductions and cattle mutilations.

1950 -- In December of 1950, a unit called IPU, "Interplanetary Phenomena Unit", was established. It was an operational unit to deal with the ever-increasing scenarios of crashed disks and aliens. That same month a disk crashed in the El Indio-Guerro area of Mexico and was taken to the AEC facility at Sandia in New Mexico. Also in 1950, the revised edition of "The Effects of Atomic Weapons" prepared by the AEC advises "complete underground placement of bases is desirable" and "there are apparently no fundamental difficulties in construction and operating underground in various types of important facilities".

1958 -- In 1958, International Geophysical Year, expeditions were made to the poles in order to again assess the problem of the Germans, as well as the threat from aliens of different character that were detected as coming from inside the Earth. Work continued on Alternatives 2 and 3. Use of the 'Orion' method of hypnosis, used on government workers in high security areas, begins.

1959 -- In 1959, the RAND Corporation held several conferences on Deep Underground Construction. These conferences were attended by the various military services as well as large corporate construction firms like Bechtel. Underground construction projects began within a year. Existing underground facilities were beefed-up and new ones were started. Funding for government underground facilities comes from

"Presidential Shelter" funds, as well as covert drug operations conducted by the CIA under the orders of MJ-12. This procedure appears to be still in effect as of July 1989. Over 75 underground facilities have been constructed under various programs.

1963 -- In 1963, John F. Kennedy evidently issued an ultimatum to MJ-12, and they decided that Kennedy should be subject to an expediency -- killed. This was the era when the United States first started having its own operational disks. 1963 is the date of one of the earliest visits to an underground joint base by an abductee that came back and lived to tell about it. It is the first hint of the underground breeding facilities that are described in the Dulce Papers, events surrounding Paul Bennewitz and Thunder Scientific Corporation in Albuquerque, New Mexico, and other insidious experiences that have been reported by scores of people from 1963 to 1989.

1964 -- In April 1964, Cape Kennedy radar technicians track disks in pursuit of the Gemeni capsule. On April 15, two intelligence personnel meet under Project Plato with aliens in the New Mexico desert to arrange a meeting on April 25 at Holloman AFB, New Mexico in order to 'renew' the treaty in a psychological bid to buy time in order to solve the problem of the Greys.

1972 -- Scientist Rene Hardy, also a prominent Ufologist, is found dead; an 'apparent' suicide... In December, astronaut Edgar Mitchell admits that NASA has provisions for encounters with alien lifeforms.

1978 -- IN September 1978, scientist Paul Bennewitz discovers the activities of alien craft at Manzano Weapons Storage area outside of Albuquerque, New Mexico. Bennewitz submits a report called "Project Beta" to the government and is put under observation. He was allegedly subjected to three bouts with electroshock treatment starting in 1979, then was left to be observed by both the government and the aliens with whom he had been communicating through his computer equipment.

1979 -- In 1979, a conference on animal mutilations was organized by Senators Harrison "Last Man on the Moon" Schmitt and attended by Scientist Henry Montieth, who had just completed ten years of research on the subject. According to Schmitt's figures, economic losses from the mutilations totaled over 2.5 million ANNUALLY. "Men In Black" are also in attendance. In October 1979, an altercation takes place between government scientists and military personnel and the resident aliens in the Dulce base. Sixty-six special forces personnel were killed.

1980 -- In May, 1980, disks intrude again into the Manzano Weapons Storage Area in New Mexico. On August 8th, a disk was discovered by a Sandia guard next to a building containing HQ CR44 [nuclear materials]. On August 9th, a security officer checks down Coyote Canyon Road and discovers a disk. By November 1980, researcher Paul Bennewitz was still being monitored by the NSA.

1983 -- FEMA implements standby legislation in a bill innocuously titled the "Defense Resources Act". The bill would SUSPEND the Bill of Rights, ABOLISH free enterprise, ELIMINATE privately owned property, and generally CLAMP the American people in a

totalitarian vise. Section 202 of the bill, for example, allows the President to instantly confiscate any real estate or personal property "that shall be deemed necessary for national defense purposes". Section 501 authorizes the takeover of any industry the White House authorizes. Section 1213 outlaws all strikes. The standby legislation also includes "Censorship of Communications," which allows the president, whenever he "shall deem that the public safety demands it," to censor "communications by mail, cable, radio, television, or other means of transmission." The 'COG' [Continuity of Government] also exists. It is a secretive shadow government that is in place and ready to run the country (from underground bases like the Mt. Weather facility near Bluemont, Virginia. In reference to the 'Executive Orders' authorizing FEMA to violate Constitutional law in time of 'Emergency', we must ask: are these Executive Orders legal? True, many of these E.O.'s were written by presidents who were duly elected by U.S. citizens who trusted the media slant concerning these presidents who came after John F. Kennedy, in spite of the fact that most of these were members of one-world economic organizations like the CFR, TC, and BILDEBERGERS. However, WHAT IF the death of John F. Kennedy was part of a coup d'etat of the Executive branch of U.S. government as many, including the late Louisiana district attorney James Garrison, claimed? If this were the case then the entire Executive branch might be filled with ILLEGAL appointees, who may have been instrumental in authorizing illegal intelligence agencies, may have illegally given power that was not meant to be theirs over to the military-industrialists, and these elected "Chief Executives" -- many of whom happened to be the hirelings of corporacratc elitists who financed their political and media campaigns -- have violated the very foundations of the United States by establishing Executive Orders which violate the U.S. CONSTITUTION, THE BILL OF RIGHTS, and THE DECLARATION OF INDEPENDENCE. I'm sure that there are still many Americans who see these three documents as being the essence of AMERICA, and they fully believe in the words penned within the DECLARATION OF INDEPENDENCE to the effect that military force is justified, if necessary, to defend from all enemies foreign AND DOMESTIC the form of government that is patterned after the sacred contents of these documents.

1985 -- ON August 5th, Scientist Paul Bennewitz observes the crash site of a US Black Delta ship in New Mexico.

1987 -- In 1987, the "Dulce Papers" are first released. Data on five entrances to the Dulce lab is leaked, and the [secret-fraternal-corporate] government takes care of the leaks by destroying buildings and building new ones in odd locations for apparently no perceivable reason. On the 27th of November, groups of US Army rangers attempt and apparently bungle an attempt to enter a joint alien facility in New Mexico [apparently, a continuation of the Dulce Wars which began in 1979]. In December, the CIA begins to contact everyone who was ever in its employ that ever had anything to do with the alien problem. A woman draws a picture of a black-mirrored spherical craft she says belongs to the National Security Agency. On the 14th of December, John Lear offers to host the MUFON Convention that would be held in Las Vegas in July of 1989.

1988 -- Word comes from New Mexico to researchers that Los Alamos has developed an antimatter weapon, which allegedly will be used as a last resort "if the Greys cannot be pried away from the planet". The number of Greys on [inside] Earth is estimated at 20 million. In December, Steven White [President of Bechtel Investments] dies. Bechtel has been heavily involved in underground construction and is the world's largest construction firm. Information comes forth that the intelligence agencies are distributing drugs to finance alien-related projects, which demand phenomenal amounts of money.

1989 -- Data on Project Excaliber is released. The project is involved in developing a warhead that will penetrate 1000 meters of earth and then detonate. Useful for destroying underground bases.

On May 14, 1989, Las Vegas channel 8 TV televises an interview with a government scientist [Robert Lazar] working at Groom Lake and Dreamland. The scientist openly tells of nine disks on the Nellis range; three of them are operational; the craft use antimatter engines; the Soviets were involved only up to a point. He won't talk about the aliens. Subsequently, the government scientist discovered that he has been the victim of a method of hypnosis known as "Orion Hypnosis". His life is threatened and his car is shot up in Las Vegas.

On June 30, July 1st and 2nd, the MUFON Conference occurs in Las Vegas, Nevada. William Cooper, John Lear, William English, and Don Ecker speak to an enthusiastic crowd. The day before, on July 1st, William Moore and a disgruntled audience have a shouting match with each other. The audience is astounded when instead of the issues at hand, Moore uses his time to attack other researchers, specifically Paul Bennewitz. William Moore publicly admits he works for a government intelligence agency.

On August 7th, US NEWS AND WORLD REPORT publishes material on "Americas Doomsday Project", detailing over 50 underground facilities that are for use during time of crisis.

In September 1989, SEVERAL west coast radio talk shows begin avid discussion of UFO's, aliens and interaction with the US Government. The public discussion is now out of control!!!

On September 23, 1989, a two-hour documentary is screened on Japanese television. Viewers are treated to the full spectrum of recent investigations, including underground labs, MJ-12, genetic facilities, the Kennedy murder, the voices of the astronauts on the shuttle talking about observing alien spacecraft, and EG&G scientist Robert Lazar talking about the disks at Groom Lake, and a visit to Dulce, where residents tell of visits from the CIA. A CIA or MIB type is photographed following the Japanese team. His Colorado license plate is readable.

On October 16th, word comes from researchers that the United States and the Soviet Union had a disagreement on the base on the far side of the Moon in which several US scientists were machine-gunned. This disagreement reflects the split between the US and Soviets detailed in the May '89 disclosure by a government scientist working at the S-4/DREAMLAND facility in Nevada [during which time the Soviets were kicked off the super-technology projects in Nevada and sent packing]. It is thought that this disagreement occurred in 1986 or 1987. [It is uncertain what connection if any this

'altercation' may have had with an alleged Reptilian/Grey take-over of an 'Alternative-2' base on Mars two years earlier in 1985, according to contactee Alex Collier].

On October 25, Congress works on legislation to make radio talk shows liable for statements made by callers in an effort to shut down talk radio programs, where UFO/Alien data is being avidly discussed. On October 26th, William Cooper goes on a radio station in Los Angeles and tells the listening public that President Bush is involved in the drug scene. The FCC attacks the talk show host the next day for "saying a bad word". Researchers speculate that the Secret Service, who allegedly terminated Sal Mineo during Reagan's administration because of an alleged homosexual tape they were concerned about, will seek to eliminate Cooper, that for some reason Cooper has now made himself expendable with this material involving the [former] President.

On November 3rd, researchers announce their discovery that a security team code-named "Yellow Fruit" was started back during the Carter Presidency, and was part of the NSA. It has been periodically disbanded and has existed in one form or another since the Carter administration. Los Angeles radio talk show host Ken Hudnell announces his intention take a group to visit one of the ancient underground cities, which he says has an entrance 60 miles from Anaheim. Researchers discover the passive security frequencies at Groom Lake; 138.306 and 407.550 and that a group codenamed Seaspray is involved with primary security in the area. Security forces then change the frequencies.

On November 6th, Channel 8 in Las Vegas starts a two-week series on Area 51, animal mutilations, and the UFO coverup. On November 10, EG&G scientist Robert Lazar goes on television and tells what he knows about US disk technology at S-4 in Area 51, including information about 9 US disks, antimatter reactors, and mind control for S-4 scientists.

On November 19th, an electrical worker at Mercury, Nevada, calls the Billy Goodman radio talk show and describes tunnels 3000 feet under the test site that have stainless steel walls and elevators. He also describes small Grey bodies on gurneys being wheeled down the tunnels.

On November 20th, a security guard on the Nevada Test Site describes his contact with a man in black that describes the whole alien scenario to him. The man has transparent eyelids.

On November 20 and 21st, the national program HARD COPY televises two programs on UFOs. EG&G scientist Robert Lazar goes on radio on KVEG for three hours and answers questions over the 50,000-watt station. Another three-hour session takes place Nov. 24th and 25th. Robert Lazar publicizes the name of his boss at Area S-4, tells that 22 people work at S-4, and how antimatter reactors work. Indications are that more people will be coming out of the woodwork to tell what they know up at Area 51.

On November 25th, television station Channel 8 in Las Vegas televises a two hour special on UFOs, Area 51, S-4 and the UFO cover-up. It is revealed that some people who contacted Channel 8 had had their homes broken into in Las Vegas.

During the week of Christmas, 1989, it was reported that there were a series of very large underground explosions in the area of the base at Dulce, New Mexico. A month EARLIER, animal mutilations began to pick up significantly. The last time these two events occurred in this order was when the government first discovered what the Greys

were up to and they tried to go in and stop them. Over 60 Delta troops were killed in the process [in the initial military attempt against the base].

1990 -- On February 17, a Ukranian astronomer detects radio emissions near Altair [Aquila], which in ancient times was associated with reptilian creatures (Note: Some contactees speak of an 'unstable' alliance between 'Nordics' and 'Greys' which has existed for a long period of time in the Altair system, as well as references to a large faction of collectist Greys who were in the process of arguing against the continued existence of humans in that and other systems, which would apparently also include the sovereigntist humans in the Andromeda and Pleiadean constellations It is stated that some fascist human elements operating within the Montauk base at the northern tip of Long Island -- who have an established an agreement with the Greys to bring about a global dictatorship on earth -- were given the 'Stargate' coordinates to generate a time-space window using Montauk technology, directly to a particular planet in the Altair system in order to assist in the suppression of a resistance movement among some of the 'Nordic' type humanoids there.

On March 3rd, Las Vegas UFOCCI chairman Stacy Borland and her brother were brutally murdered while at home. [Stacy was attempting to get information out about a group of Mercury, Nevada construction workers and electricians who claimed that some of their fellow workers had been abducted and were being held captive in a vast underground system there]. On March 8th, the final destruction of the 4th amendment of the U.S. Constitution takes effect very quietly behind the scenes. Now the authorities need no warrant or probable cause to break into a person's home and perform any action they think fit. Suspicion is sufficient.

UFO Crashes



Here are some UFO crashes that you might not have been aware of:

List #1

Unknown - Beaver Oklahoma (ancient crash site still believed by some to be buried under Sand Hills of Beaver State Park) Bodies Unknown

Unknown - Steppes Mountains (ancient crash sight.) Some wreckage reported recovered in Arch. dig 1956 No Bodies

August if 1897 Aurora, Texas 1 Body -buried in Local cemetery

July 4,1947 Roswell, New Mexico 4 Bodies

Feb 13,1948 Aztec, New Mexico 12 Bodies

July 7,1948 Mexico, so. of Laredo 1 Body

1949 Roswell, New Mexico 1 ET Living

1952 Spitzbergen, Norway 2 Bodies

Aug 14,1952 Ely, Nevada 16 Bodies

Sept 10,1950 Albuquerque, New Mexico 3 Bodies

April 18,1953 S.W. Arizona No Bodies

May 20,1953 Kingman, Arizona 1 Body

June 19,1953 Laredo, Texas 4 Bodies

July 10,1953 Johannesburg S. Africa 5 Bodies

Oct 13,1953 Dutton, Montana 4 Bodies

May 5,1955 Brighton, England 4 Bodies
 July 18,1957 Carlsbad, New Mexico 4 Bodies
 1961 Timmensdorfer, Germany 12 Bodies
 June 12,1962 Holloman, AFB, New Mexico 2 Bodies
 Nov 10,1964 Ft. Riley, Kansas 9 Bodies
 Oct 27,1966 N.W. Arizona 1 Body
 1966-1968 5 Crashes IN/KY/OH/ area 3 Bodies and Disc Intact
 July 18,1972 Morocco Sahara Desert 3 Bodies
 July 10,1973 NW Arizona 5 Bodies
 Aug 25,1974 Chihuahua, Mexico Bodies and Disc intact
 May 12,1976 Australian Desert 4 Bodies
 June 22,1977 NW Arizona 5 Bodies
 April 5,1977 SW Ohio 11 Bodies
 Aug 17,1977 Tobasco, Mexico 2 Bodies
 May 1978 Bolivia No Bodies
 Nov 1988 Afghanistan 7 Bodies
 May 1989 South Africa 2 ET Living
 June 1989 South Africa 2 ET Living Disc Intact
 July 1989 Siberia 9 ET Living
 Sept 2,1990 Megas Platonos, Greece
 Nov 1992 Long Island, New York

List #2

This is a brief synopsis of UFO Crash reports and military retrievals from file 23.

1. July 4, 1947 (Roswell, NM) Most famous of the UFO Crash cases and most thoroughly investigated. William (Mac) Brazel, a local rancher, reported hearing a loud explosion during the night of a thunderstorm. The next day Brazel found a debris field on his ranch. Word reached Major Jesse Marcel at the Roswell Army Air Field and he investigated. Marcel reported finding a debris field scattered over a mile. The material recovered from the debris included small beams with hieroglyphics on them; metal that was as light as balsa wood, but couldn't be dented with a sledge hammer, although flexible. The material would not burn. The scrap material was flown to Carswell AFB in Fort Worth. Witnesses have described a second site where the main body of the craft was found along with the bodies of its crew.
2. Oct, 1947 (Cave Creek, AZ) Not much is known about this crash. There is still one living witness in Prescott, AZ.
3. Mar 25, 1948 (Aztec, NM) Though still considered a hoax by most researchers, others have left the door open on this one. A new first-hand witness has been found in Las Vegas. Story is that a large disc said to be 99 feet in diameter came down in Hart Canyon and that a military recovery team was dispatched from Durango, CO.
4. Mar 1948 (Socorro, NM) A second craft came down in this vicinity that was much like the Aztec craft according to an ex-army private.

5. Aug 14, 1952 a disc crashed near Ely, NV, and 16 bodies were recovered.

6. May 20, 1953 (Kingman, AZ) An engineer who reported this event said 1 or 2 bodies were recovered. He rode a bus with darkened windows from the Nevada Test Site to the crash location. The disc was found embedded in the sand and canted at an angle. His job was to determine the disc's trajectory and velocity.

There have been rumors of additional crashes including a controversial report of a South African Mirage jet fighter shooting down a disc over the Kalahari Desert in Botswana on May 7, 1989. There are also reports of a disc crash in Chihuahua, Mexico on August 25, 1974 and one in Megas Platanos on September 2, 1990 in central Greece. Few of these reports have been investigated as thoroughly as Roswell, but that does not mean they should be dismissed.

An FBI MEMO from March 22, 1950 alludes to 3 saucers recovered in New Mexico. This memo also states that it was believed that a radar station interfered with the saucers' control mechanisms causing them to crash. If that is true, then such a discovery would suggest the idea of a weapon that could be used to bring saucers down.

7. In Beaver Oklahoma crash site (alleged) believed to be the cause or effect of phenomena known as the "Beaver Sands Portal." A supposed dimensional door way to other worlds first experienced by native Americans of the area, and then white men starting with Coronado's Expedition who camped near the sand dunes. Green light and eerie sensations on the skin mark this experience, along with a small number of disappearances in to the Portal spread out over the last 4 centuries.

List #3

Here is another file of researched crashed disks:

April 17, 1897 - Aurora, Texas

A mysterious airship is said to have crashed in this town, exploding into many small fragments. Reportedly, the occupant was child-size and greenish, and the craft contained papers covered with hieroglyphics. The pilot's body is supposed to be buried in the local cemetery. Although the case was widely regarded as a hoax, new investigation brought to light a peculiar alloy that was eventually analyzed by the McDonnell Aircraft Company.

Dec. 22, 1909 - Chicago

Six years after Kitty Hawk, newspapers from New York to Chicago were astounded by national reports of a huge airship flying across the nation and seen by thousands. It crashed west of Chicago, but was never found. The story was front-page news in the nation's major newspapers.

1933 or 1934 - Ubatuba, Brazil Witnesses on a beach are said to have seen a disc dive and explode, showering the area with silvery fragments of highly pure magnesium.

May, 1947 - Spitzbergen, Norway

A report by journalist Dorothy Kilgallen stated that British scientists and airmen were excavating the wreckage of a mysterious flying ship. The Swedish military acknowledged its extraterrestrial origin and reported 17 bodies were found. The story appeared as a tiny blip for only one day in the U.S. news media before it was silenced by the military. I personally saw this news story years ago.

July 2, 1947 - Roswell, New Mexico

The most famous and thoroughly investigated by journalists, this is the crash that launched Majestic-12. It was the first and only time the U.S. government publicly admitted it had recovered a crashed flying saucer. Within hours, the craft was whisked off to Wright-Patterson AFB and a new cover story emerged, claiming it had been only a weather balloon. In recent years, the officer responsible for that cover story has recanted. Three or four humanoid bodies were recovered; one was alive for a short time.

February 13, 1948 - Aztec, New Mexico

Three radar units tracked a falling UFO. Secretary of State George C. Marshall requested a search party be dispatched from Camp Hale in Colorado. A helicopter team found a crashed 30-foot disc 12 miles northeast of Aztec and recovered 2-12 badly burned humanoids. The disc is stored in Hangar 18 at Wright-Patterson AFB near Dayton, Ohio.

August 1948 - Laredo, Texas

Four officers witnessed the crash of an object and the recovery of bodies 38 miles south of Laredo, Texas, in Mexico. The information came from an NBC affiliate in Chicago, who received it from a source in Army security.

August 19, 1949 - Death Valley, California,

Two prospectors named Mace Garney and Buck Fitzgerald claimed to have watched an object crash in the desert. It was a 24-foot disc. The story appeared on page 13 of the local Bakersfield newspaper the next day.

April 1950 - Argentina

Mr. E.C. Bossa found a strange disc and four small dead pilots in a remote region of Argentina. He returned with a friend the next day and found only a pile of warm ashes. A cigar-shaped object was seen briefly as it flew overhead at a high altitude.

1953 - Brady, Montana

Mr. C.M. Tenney, returning from Great Falls to Conrad, saw an oval object that followed his car while balls of fire fell all over the road. Later that day he was phoned by a colonel from Malmstrom AFB who asked him to come to the base at 10 a.m. the next day. He was escorted to a windowless room inside a fenced-off compound and asked to sign a statement. While doing so, he says he saw two men carrying large laundry bags containing humanoid bodies.

May 21, 1953 - Kingman, Arizona

A USAF veteran claims to have participated in the recovery of a crashed aluminum-like disc impacted 20 inches into the earth. It was oval, 32 feet wide. Inside were two swivel chairs, an oval cabin and numerous instruments. One 4-foot-tall occupant was recovered, dead. It had a dark brown complexion and wore a silvery metal suit with no helmet. The witness' affidavit was released by respected UFO researcher Ray Fowler in UFO Magazine, April 1976.

Mid-1950s - Birmingham, Alabama

When a disc crashed near Birmingham, the area was cordoned off and humanoid bodies were flown to Maxwell AFB, according to a man who claims to have flown the helicopter with the bodies to a waiting aircraft.

Spring 1954 - Mattydale, NY

In this suburb of Syracuse, at 3 a.m. on a Sunday, an information specialist and his wife saw a 20-foot-wide object being examined on the ground by several men who were taking pictures. The next day an officer told them the event was a military secret. Later, police denied the whole incident ever took place.

1959 - Frdynia, Poland

An object was reported to have fallen into the harbor. Divers recovered pieces of shiny metal, which was examined by the Polytechnic Institute and Polish Navy. Some material was reportedly lost. Several days later a small humanoid was found on a nearby beach; its remains were sent to the Soviet Union.

March 1960 - New Paltz, NY

Local law enforcement authorities captured a small humanoid outside his craft while two copilots escaped. The alien was turned over to the CIA and died 28 days later.

January 1967 - Southwest Missouri

A Mr. Loftin found a 40-inch disc and gave it to the U.S. Testing Company for analysis.

November 9, 1974 - Carbondale, NJ

A glowing object fell into a small lake outside town. Three teenagers saw it fall at 7:30 p.m. on a Saturday. They observed a yellow-white glow under the water that shifted to a point 25 feet offshore. The boys were kept in a police car for three hours while a number of vehicles with floodlights and cranes removed a disc-shaped object and put it into a van. The following Monday, a railroad lantern and battery were recovered from the lake and officials called the whole thing a hoax. Hoax? Or cover story?

May 17, 1974 - Chili, NM

An Air Force team allegedly removed a 60-foot-wide metallic object from an impact area and moved it to Kirtland AFB.

May 6, 1978 - Padcaya, Bolivia

A large luminous object crashed on a 13,000-foot mountain. An expedition of soldiers and scientists was dispatched to the site, but was delayed by bad weather. They found nothing.

1978 - Soviet Union

After a collision with a Soviet fighter plane, a disc-shaped object fell into the ocean off Finland, where it was recovered with humanoid bodies - by a Soviet salvage team.

More info at:

<http://www.blue-planet-project.com/ufo-crashes-secret-files-revealed.html>

Are Many of the UFO Sightings Today Actually Ours?

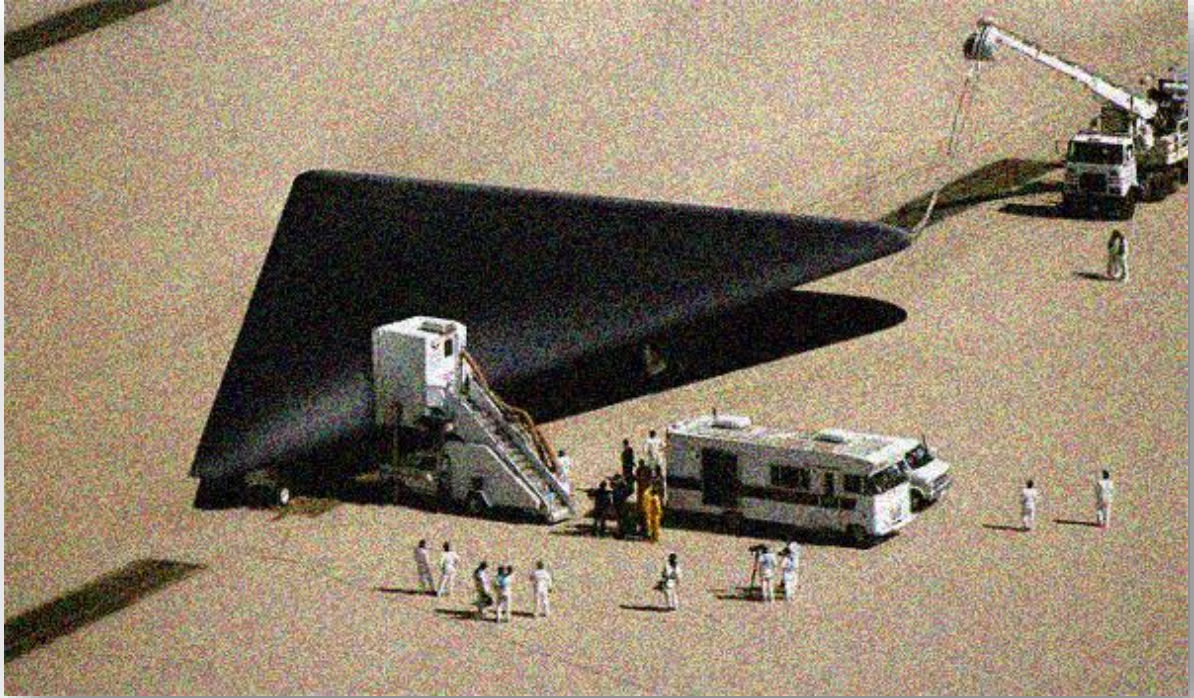

Could most UFO sightings be caused by advanced anti-gravity military aircraft? Anti-gravity technology is here now! The TR-3B for example is triangle-shaped, can move at incredible speeds and is difficult to be detected by radar. Sightings of this unit are increasing all around the globe.

This is not official however...yet

“It doesn’t exist officially...It uses highly pressured mercury accelerated by nuclear energy to produce a plasma that creates a field of anti-gravity around the ship. Conventional thrusters located at the tips of the craft allow it to perform all manner of rapid high-speed maneuvers along all three axes.

Interestingly, the plasma generated also reduces radar signature significantly. So it'll be almost invisible on radar & remain undetected. This literally means that it can go to any country it likes without being detected by air traffic control & air defense systems."

The triangle-shaped aircraft has been shrouded in conspiracy and made famous during the "Phoenix Lights" incident, in which over 700 people witnessed a boomerang shaped object floating in the sky over Phoenix, Arizona.

Governor Fife Symington III requested information from the commander of Luke Air Force Base, the general of the National Guard, and the head of the Arizona Department of Public Safety. But none of the officials he contacted had an answer.

Frances Barwood, the 1997 Phoenix city councilwoman who launched an investigation into the event, said that of the over 700 witnesses she interviewed, "The government never interviewed even one" which may suggest that the United States Military is responsible for these UFO sightings.

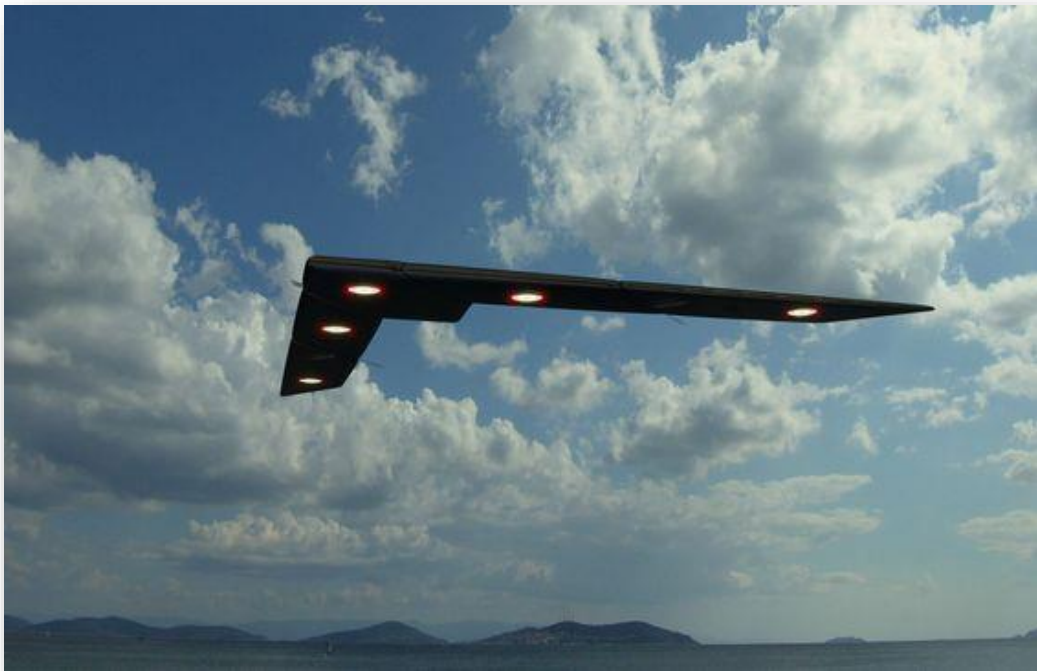

Another rumored unit is the TR-6 Telos

The TR6 "TELOS" is designed for use as a transatmospheric, low observable reconnaissance platform with global reach and a long loiter time over target. Employing active electromagnetic, electronic and visual camouflage it is able to penetrate all currently known defensive systems from trans-orbital height.

The TR6 utilizes five electrogravitic generators for propulsion and is considered a “VTOL” craft not needing a runway. The landing gear is strictly for maneuvering while on the ground. The wings fold for hangar stowage. Currently there are only a handful of hangars in the world that can accept the TR6, with most of them in the US.

The entire airframe acts as a multi-band communications relay capable of directly interfacing with all current US military satellite networks. The skin employs active visual camouflage using a ‘starfield’ lighting pattern along with other active stealth techniques. The TELOS platform is also capable of operating in space as well as docking with military space stations via a ventral docking hatch.

Signs of Possible Alien Abduction



Jefferson Souza had alien contacts and abductions beginning at an early age. Many of us may also have had these experiences but we were unable to remember them for several reasons: Such as our mind is blocking or these aliens are blocking our memories of some or all of these experiences. This chart may be helpful.

1 – LOST TIME: A period of time, from minutes to several days, in which you cannot recall what happened to you or what you have done.

2 – UNUSUAL MARKS: On your body like scars, scoop marks, laser cuts in series on ankle, wrist or back. Any scars which you're unable to explain where you got them from.

3 – TAPPING OR HUMMING NOISES: Hearing these sounds upon odd occasion such as bedtime, just prior to sleep

4 – BEING WATCHED: A feeling you get, during or just prior to sleep at night.

5 – SLEEPWALKING: You wake up in a different place from where you went to sleep and do not know how you got there.

6 – SEEN A UFO: During your life you've seen UFO's or seen strange lights in the sky.

7 – NEED TO TRAVEL: A strange compulsion to walk or drive to another location without any explanation.

8 – UNEXPLAINED MEDICAL PROBLEMS: Sudden illness, sinus problems, fatigue, migraines or rashes.

9 – UNABLE TO SLEEP: You experience insomnia by way of nightmares, dreaming of UFO's or being devoured by animals with large black eyes. (Usually associated with common wild animals such as owls, coyotes or wolves.)

10 – IMPLANTS: Your physician or you discover small, strange object inside your body that cannot be explained. Common places are the hip, ankle, foot, nose or hand.

11 – TERMINATED PREGNANCY: You become pregnant and within a few months the pregnancy is terminated, without any explanation or discharge.

12 – SPERM SAMPLES: You believe you have had intercourse in the night or have had semen extracted from your body.

13 – PSYCHIC ABILITIES: You suddenly feel as though you have obtained some degree of psychic ability without any explanation for it.

14 – PARALYZED IN BED: Waking with immobility. For some reason you cannot move your body for a few seconds or minutes.

15 – BALLS OF LIGHT: Flashes of light or beams of light glimpsed through the corner of your eyes or seen directly, head on in your bedroom at night.

16 – DREAMS OF FLYING: Repeated dreams of having the ability to fly or of flying over your house or a familiar area.

17 – STRONG MEMORY: A very strong memory of something unusual such as floating through the air, lying upon an examination table, seeing a hypodermic needle or seeing a strange, skinny baby.

18 - COSMIC AWARENESS: A sudden interest in ecology, environment, vegetarianism or you just become very socially conscious for no apparent reason in your adult life.

19 – YOUR MISSION: You become aware of a strong sense of duty, a mission in life. You have a compulsion to fulfill a task in life but you don't know exactly what it is or why you have this feeling.

20 – "SPECIAL": You have a feeling that secretly, known only to yourself, you are special or chosen by someone, somehow.

- 21 – UNEXPLAINED EVENTS: You have had occurrences in your life which you cannot understand or explain to anyone.
- 22 – PSYCHIC: You have had the experience of knowing something was going to happen before it happened and then – it did happen!
- 23 – EYE DREAMS: You remember dreaming about large eyes. Usually familiar wildlife animals such as deer, elk, moose, owl, wolf or coyote. All you remember about the dream are the unusually large eyes.
- 24 – STARTLED: You awaken in the night, sometimes frequently, feeling a sense of panic or anxiety for no apparent reason.
- 25 – PICTURES OF ALIENS: You have an aversion to looking at any picture or drawing of an alien, similar to the greys shown on the cover of the book: "Communion".
- 26 – FEARS OR PHOBIAS: You have inexplicable feelings of aversion to heights, snakes, spiders, large insects, certain sounds, bright lights, personal safety and/or a fear of being alone.
- 27 – SPECIAL PLACE: You have a memory of a special place with spiritual significance when you were a youngster.
- 28 – SELF-ESTEEM PROBLEMS: You have experienced that low worth feeling much of your life.
- 29 – SEEN IN SLEEP: Someone with you, a partner, become paralyzed, motionless or frozen in time, especially at or during bedtime.
- 30 – CRAFT OR ALIEN: You have someone in your life who claims to have seen a UFO, been abducted or has witnessed missing time.
- 31 – BLOOD: You have had times when you found blood, or small drops of blood on your pillow with no explanation how it got there.
- 32 – UFO'S OR ALIENS: You have had an interest in these topics in your mind with no idea why.
- 33 – AVERSION: You have an extreme aversion to talking, seeing or listening to any mention of the subject of UFO's, aliens or abductions.
- 34 – BEING WATCHED: You have the feeling you are being watched most of the time, especially at night.
- 35 – SOLID OBJECTS: You have the feeling of having had your body pass through solid objects such as doors or windows.
- 36 – FOG OR HAZE: You have seen fog or haze when it should not have been there.

- 37 – NOSE BLEEDS: You have had nose bleeds at some time in your life without apparent cause or you have awoken with a nose bleed.
- 38 – SORENESS: You awaken with soreness in your genitals which cannot be explained.
- 39 – BACK OR NECK PROBLEMS: Your back aches without cause or you awaken with unusual stiffness in any part of your body
- 40 – ELECTRONIC MALFUNCTION: Certain electronic appliances, (computers, digital watches, etc.) seem to malfunction in your presence with no explanation. Street lights going out when you walk under them or radio and television being affected when you walk by.
- 41 – RINGING IN THE EARS: Frequent or sporadic ringing in your ears on just in one ear.
- 42 – BEHIND YOUR EYE: A headache, especially in the sinus, or in just one ear.
- 43 – MEDICAL PROCEDURES: Dreams of doctors doing medical procedures upon your body.
- 44 – GOING CRAZY: Having the feeling that you are going insane for even thinking about these sorts of things.
- 45 – PARANORMAL: Experiencing psychic or odd experiences including intuition.
- 46 – COMPULSIVE/ADDICTIVE: This behavior either throughout your life or onset at adulthood.
- 47 – URGE TO TAKE VITAMINS: Do you feel compelled to take more vitamins as the years pass? Do you feel somehow it is helping 'replenish' your body?
- 48 – AFRAID OF THE CLOSET: Have you ever been or are you now afraid of your closet or any closet in the house, having to make certain the door(s) are always shut?
- 49 – SEXUAL OR RELATIONSHIP PROBLEMS: Have had or are having an odd feeling that you must not become involved in a relationship because it would interfere with something.
- 50 – REMAIN VIGILANT: Fear that if you do not remain vigilant you will be taken away by someone.
- 51 – DIFFICULTY TRUSTING: Have trouble trusting other people, especially authority figures such as doctors
- 52 – DREAMS OF DESTRUCTION: Dreams about catastrophes such as the end of the world.

- 53 – DON'T TALK: You have the feeling you should not talk about these things or that you are not supposed to talk about these things.
- 54 – SLEEP AGAINST THE WALL: You feel you must have your bed against the wall.
- 55 – LOCKING ALL DOORS: You double and triple-check locking up at night to prevent something or someone getting into your home.
- 56 – CHILDREN OR PARENTS: Have talked about things on this list or you have heard them talk to others about things on this list.
- 57 – NO SUCCESS: You have tried to resolve some of these problems in your mind but with little success.
- 58 – NO RECALL: You have experienced many of these traits but cannot remember anything related to any abduction experience.
- 59 – DREAMS OF FLOATING THROUGH WINDOWS
- 60- DREAMS OF FLOATING IN A BEAM OF LIGHT
- 61 – DREAMS OF ALIENS, DOCTORS AND OPERATIONS
- 62 – COMPULSION TO BECOME A VEGETARIAN
- 63 – COMPULSION TO STUDY ASTRONOMY
- 64 - COMPULSION TO STUDY QUANTUM PHYSICS
- 65 – EXPERIENCE SYNCHRONISTIC HAPPENINGS
- 66 – EXPERIENCE BEING OUT OF BODY (OBE)
- 67 – EXPERIENCE FLASHBACKS – (Strange craft, conference, corridors, glowing-misty oval room with table, alien exam, instruments, babies, hybrid children, UFO sightings, etc.)
- 68 – HAVE FEAR/WARINESS OF A CERTAIN PLACE
- 69 – HISTORY OF FAMILY UFO EXPERIENCES
- 70 – SEE SAME NUMBERS ON THE CLOCK LINED UP (Such as awakening at 1:11 a.m. or 3:33 a.m.)
- 71 – SEE HOODED FIGURES, STRANGERS DRESSED IN BLACK
- 72 – AWAKE IN OTHER POSITION

Examples of reported markings from alien abductions



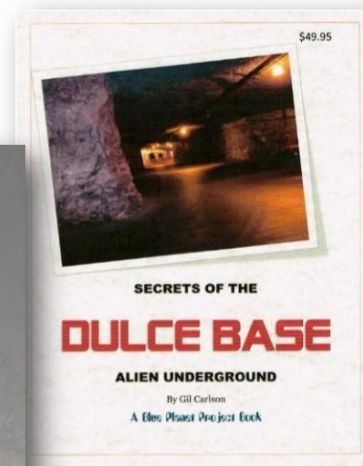
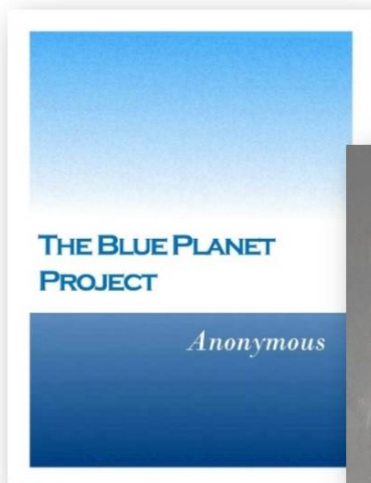

More Books in the Blue Planet Project Series
Check out the website:

www.blue-planet-project.com/

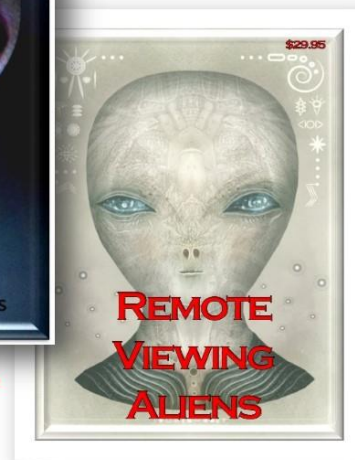

Each book is also available
on **Amazon.com**

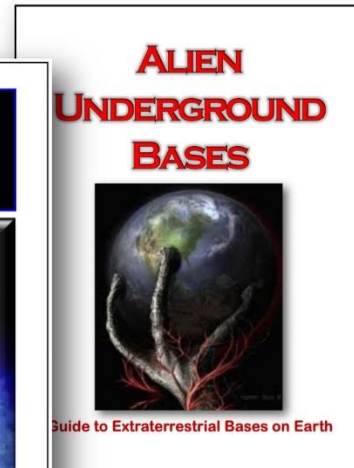
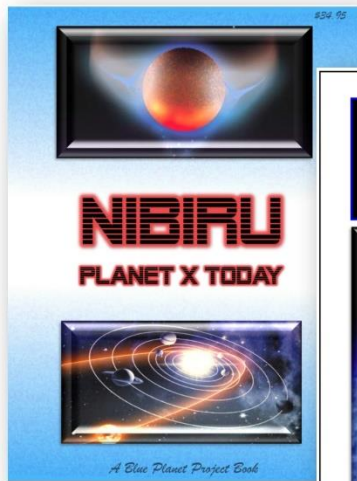

More Books in the Blue Planet Project Series
Check out the website:

www.blue-planet-project.com/

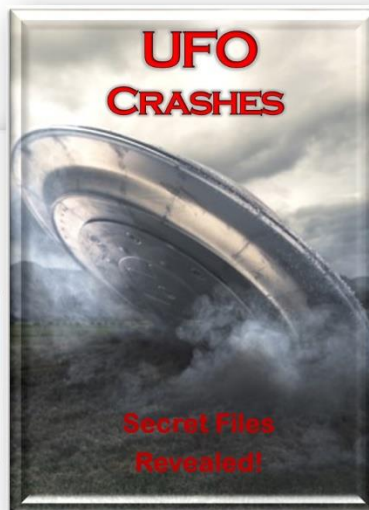

Each book is also available
on **Amazon.com**